

Luftpistol

Umeå Pistolskytteklubb

Dam

10.01.2025

Vinterträffen 2025

Umeå skytteallians

Serie 1

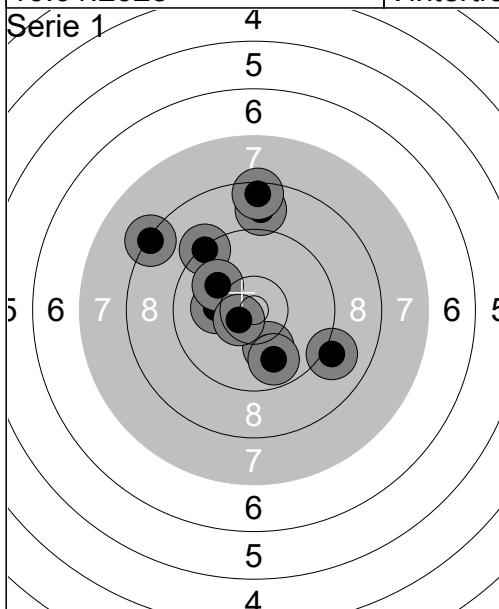

1: 9.3 ↗
 2: 8.8 ↑
 3: 9.0 ↘
 4: 10.1 ←
 5: 10.1 ↓
 6: 9.8 ↓
 7: 10.0 ↗
 8: 10.6x ↙
 9: 8.5 ↑
 10: 8.3 ↖

Serie 91 (1x)

Total 91 (1x)

Serie 2

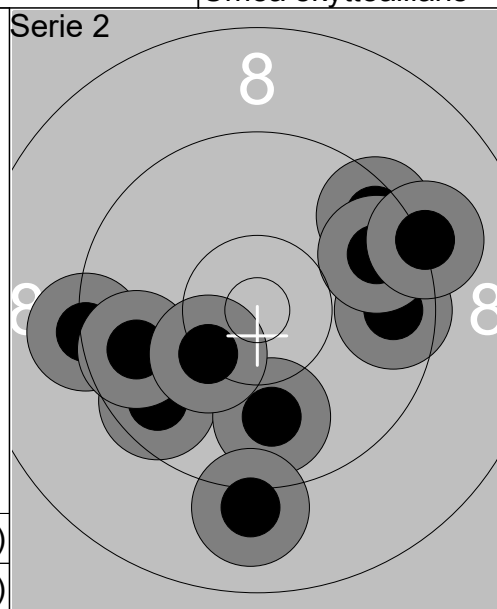

1: 9.6 ↙
 2: 9.9 ↓
 3: 9.3 ←
 4: 9.5 ↗
 5: 9.0 ↓
 6: 9.6 →
 7: 9.7 ←
 8: 10.3 ↙
 9: 9.7 ↗
 10: 9.2 ↗

Serie 91 (0x)

Total 182 (1x)

Serie 3

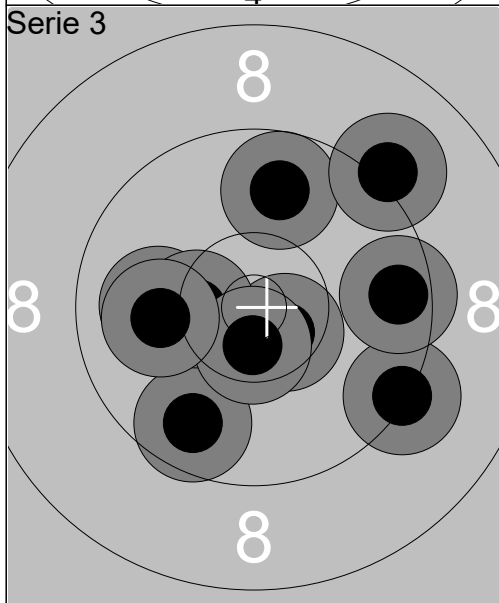

1: 10.6x ↘
 2: 9.8 ↑
 3: 10.0 ←
 4: 9.7 ↓
 5: 9.3 ↘
 6: 10.4x ←
 7: 10.6x ↓
 8: 9.1 ↗
 9: 10.0 ←
 10: 9.6 →

Serie 95 (3x)

Total 277 (4x)

Serie 4

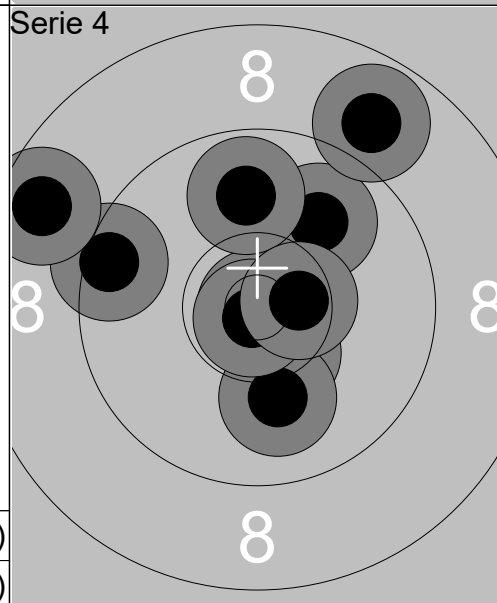

1: 10.9x ←
 2: 10.4x ↓
 3: 10.1 ↓
 4: 10.8x ↓
 5: 9.9 ↗
 6: 9.9 ↑
 7: 8.8 ↗
 8: 9.5 ←
 9: 8.6 ↖
 10: 10.5x →

Serie 93 (4x)

Total 370 (8x)

Serie 5

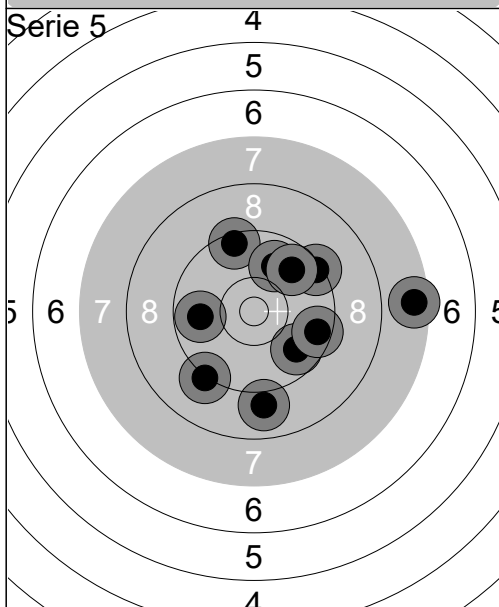

1: 9.8 ←
 2: 9.4 ↑
 3: 8.9 ↓
 4: 9.2 ↙
 5: 9.7 ↘
 6: 9.9 ↑
 7: 7.5 →
 8: 9.5 →
 9: 9.4 ↗
 10: 9.7 ↗

Serie 87 (0x)

Total 457 (8x)

Serie 6

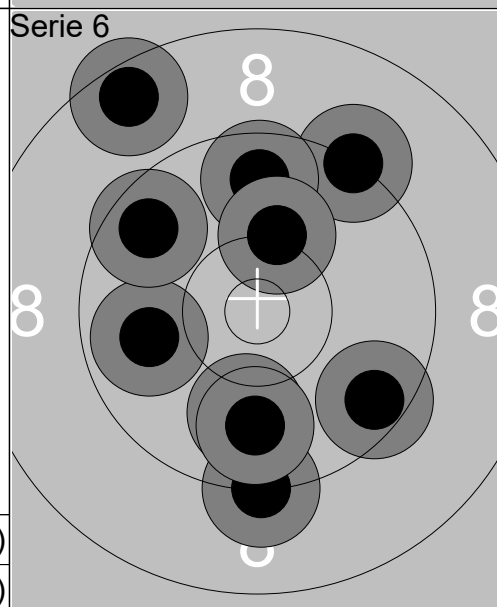

1: 8.5 ↗
 2: 9.2 ↗
 3: 9.9 ←
 4: 9.5 ↘
 5: 10.0 ↓
 6: 9.6 ↖
 7: 9.7 ↑
 8: 10.2 ↑
 9: 9.2 ↓
 10: 9.8 ↓

Serie 91 (0x)

Total 548 (8x)

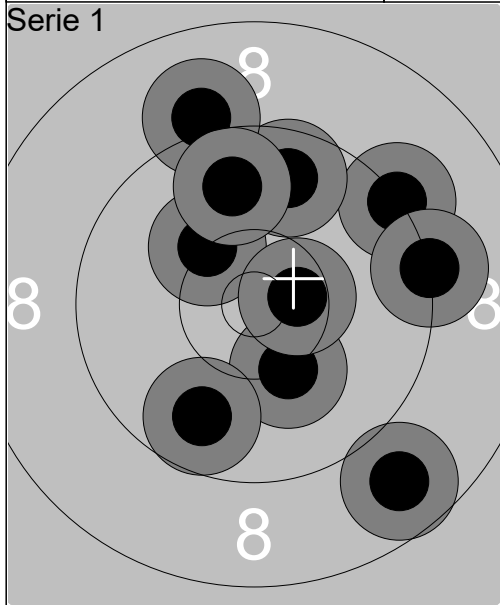

1:	9.2	↗
2:	10.2	↖
3:	8.7	↘
4:	9.2	→
5:	9.7	↑
6:	9.1	↑
7:	10.2	↘
8:	9.8	↑
9:	9.8	↘
10:	10.5x	→
Serie		92 (1x)
Total		92 (1x)

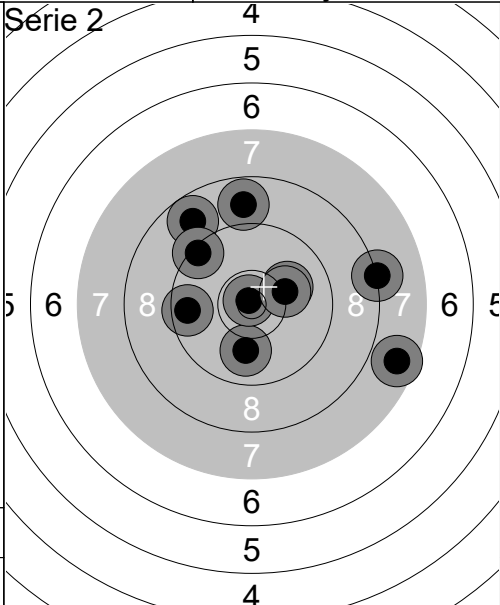

1:	9.9	↓
2:	9.6	←
3:	7.6	→
4:	8.8	↖
5:	10.1	↗
6:	8.8	↑
7:	9.4	↖
8:	8.2	→
9:	10.8x	↖
10:	10.2	↗
Serie		88 (1x)
Total		180 (2x)

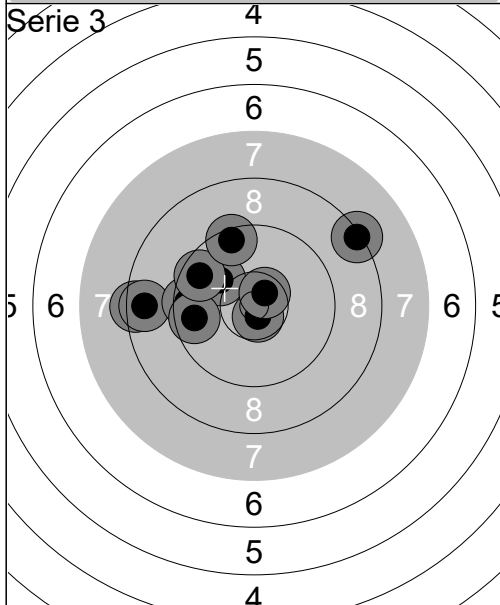

1:	8.3	↗
2:	8.4	←
3:	8.6	←
4:	10.7x	↘
5:	9.5	←
6:	10.0	↖
7:	10.6x	↗
8:	9.6	←
9:	9.6	↖
10:	9.5	↑
Serie		90 (2x)
Total		270 (4x)

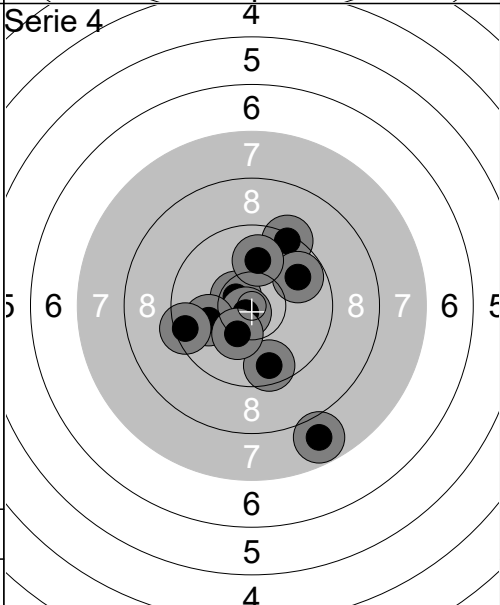

1:	7.8	↘
2:	9.4	↖
3:	10.5x	↖
4:	10.8x	↘
5:	9.8	↗
6:	9.6	↘
7:	10.0	←
8:	10.0	↑
9:	9.4	←
10:	10.3	↘
Serie		93 (2x)
Total		363 (6x)

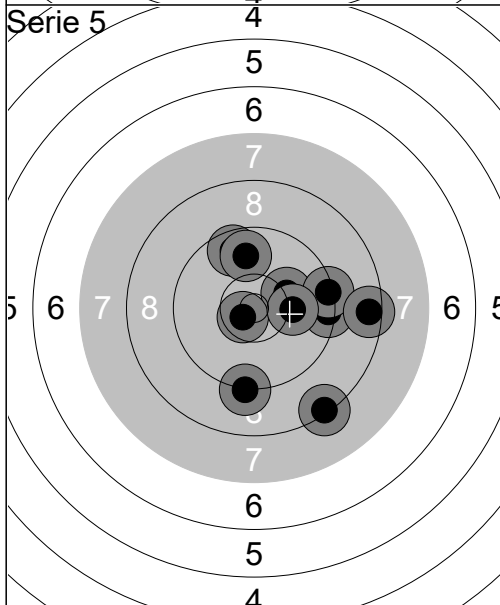

1:	9.4	→
2:	8.3	↘
3:	10.2	↗
4:	9.3	→
5:	9.6	↑
6:	10.6x	↖
7:	10.1	→
8:	9.8	↑
9:	9.2	↘
10:	8.5	→
Serie		91 (1x)
Total		454 (7x)

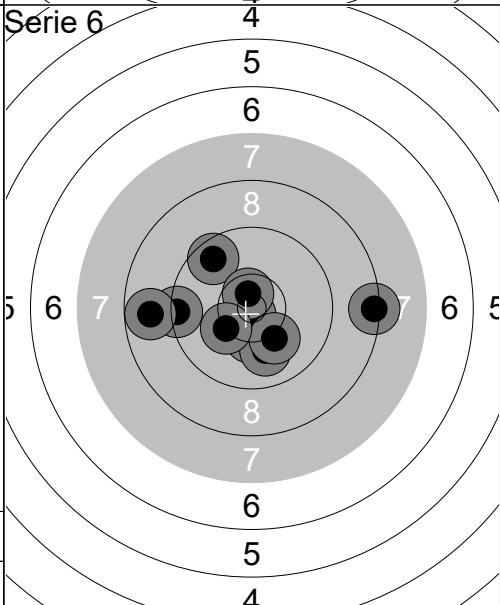

1:	10.3	↓
2:	9.4	←
3:	10.0	↘
4:	8.3	→
5:	10.8x	↘
6:	10.1	↘
7:	9.6	↖
8:	10.6x	↑
9:	8.8	←
10:	10.2	↘
Serie		94 (2x)
Total		548 (9x)

Luftpistol

Umeå Pistolskytteklubb

Vet2

10.01.2025

Vinterträffen 2025

Umeå skytteallians

Serie 1

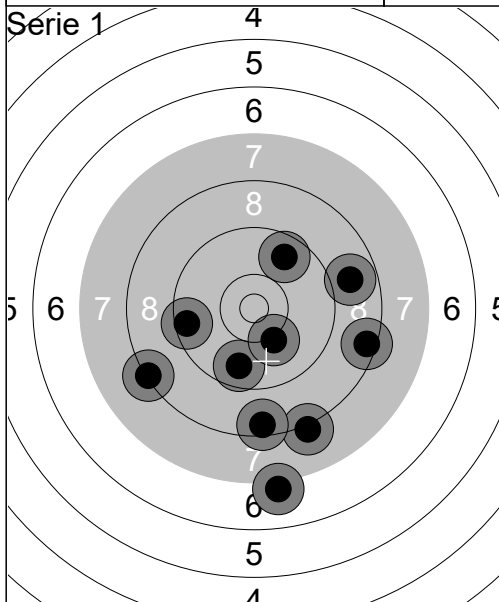

1: 9.7 ↓
 2: 9.7 ↗
 3: 9.5 ←
 4: 8.8 →
 5: 10.2 ↓
 6: 7.1 ↓
 7: 8.4 →
 8: 8.1 ↓
 9: 8.3 ↖
 10: 8.5 ↓

Serie 84 (0x)

Total 84 (0x)

Serie 2

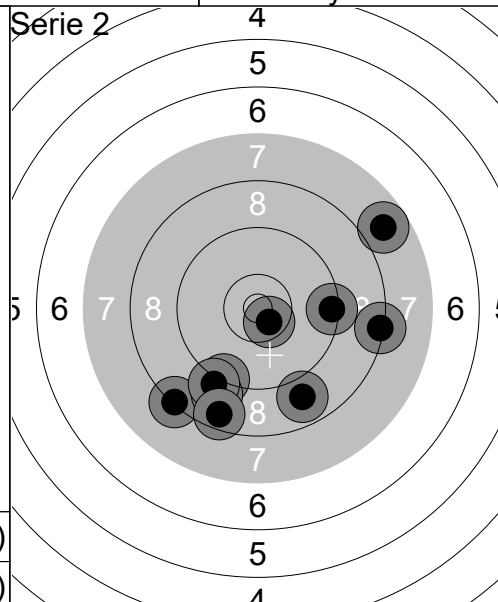

1: 10.6x ↘
 2: 8.3 ↙
 3: 8.3 →
 4: 9.3 ↓
 5: 8.8 ↓
 6: 8.9 ↓
 7: 7.8 ↗
 8: 9.4 →
 9: 9.1 ↓
 10: 8.5 ↓

Serie 84 (1x)

Total 168 (1x)

Serie 3

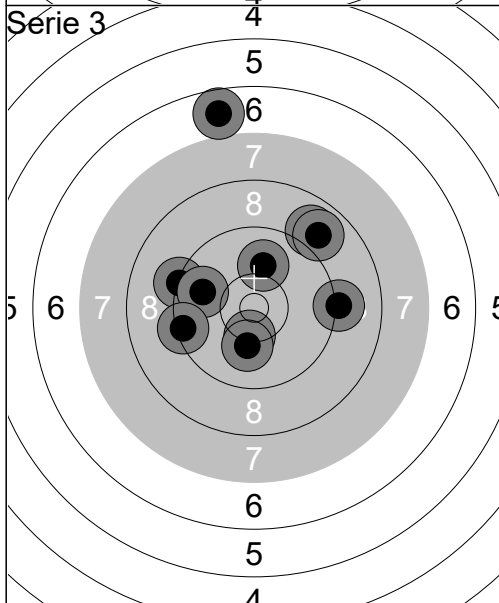

1: 9.3 ←
 2: 6.7 ↑
 3: 9.8 ←
 4: 10.0 ↑
 5: 10.3 ↓
 6: 8.9 ↗
 7: 8.9 ↗
 8: 10.1 ↓
 9: 9.1 →
 10: 9.4 ←

Serie 88 (0x)

Total 256 (1x)

Serie 4

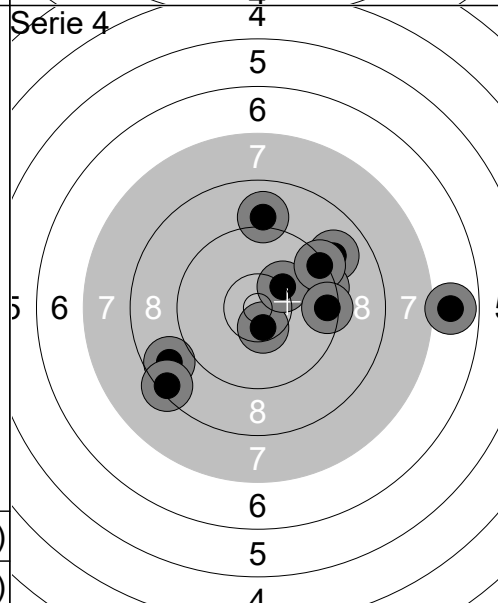

1: 8.7 ↙
 2: 9.0 ↗
 3: 9.5 →
 4: 10.5x ↓
 5: 9.0 ↑
 6: 6.8 →
 7: 8.4 ↙
 8: 10.2 ↗
 9: 9.4 ↗
 10: 9.5 →

Serie 87 (1x)

Total 343 (2x)

Serie 5

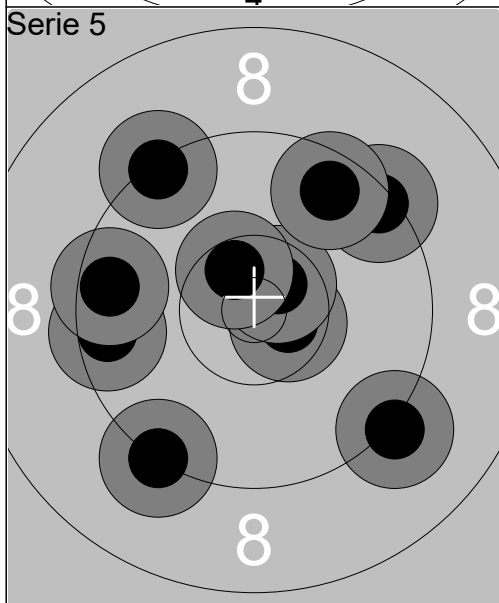

1: 9.5 ←
 2: 10.6x →
 3: 9.2 ↙
 4: 9.4 ↗
 5: 9.3 ↗
 6: 9.5 ←
 7: 9.2 ↘
 8: 10.6x ↗
 9: 10.5x ↖
 10: 9.6 ↗

Serie 93 (3x)

Total 436 (5x)

Serie 6

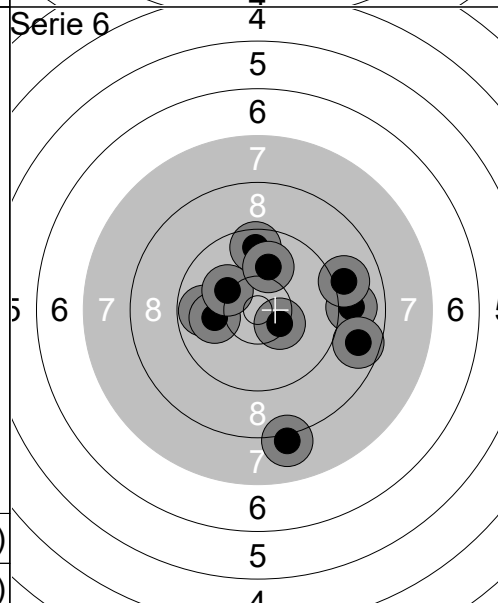

1: 8.1 ↓
 2: 9.8 ←
 3: 10.0 ←
 4: 9.6 ↑
 5: 8.9 →
 6: 10.2 ↖
 7: 8.7 →
 8: 9.0 →
 9: 10.4x ↘
 10: 10.0 ↑

Serie 91 (1x)

Total 527 (6x)

Luftpistol

Rundviks Pistolskytteklubb

Vet2

10.01.2025

Vinterträffen 2025

Umeå skytteallians

Serie 1

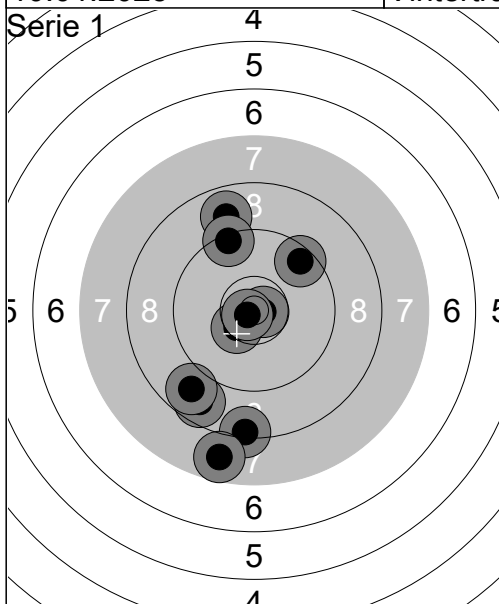

1: 8.4 ↓
 2: 8.9 ↑
 3: 7.7 ↓
 4: 10.7x →
 5: 8.7 ↓
 6: 8.8 ↓
 7: 9.5 ↗
 8: 9.4 ↑
 9: 10.4x ↙
 10: 10.8x ↙

Serie 87 (3x)

Total 87 (3x)

Serie 2

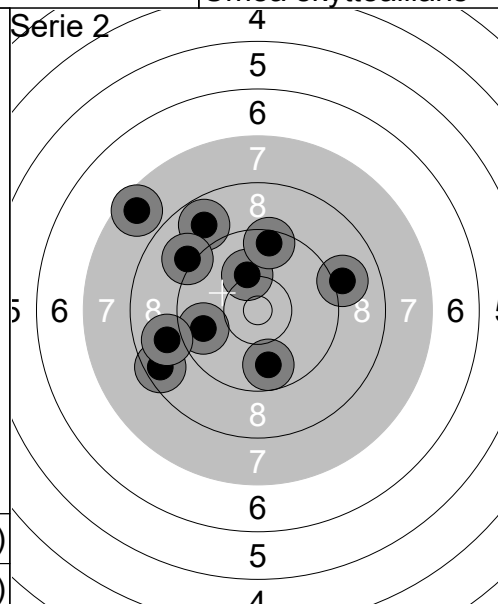

1: 8.5 ↙
 2: 8.8 ↗
 3: 9.7 ↙
 4: 9.0 →
 5: 9.1 ↗
 6: 9.8 ↓
 7: 10.2 ↑
 8: 9.5 ↑
 9: 7.6 ↙
 10: 8.9 ↙

Serie 86 (0x)

Total 173 (3x)

Serie 3

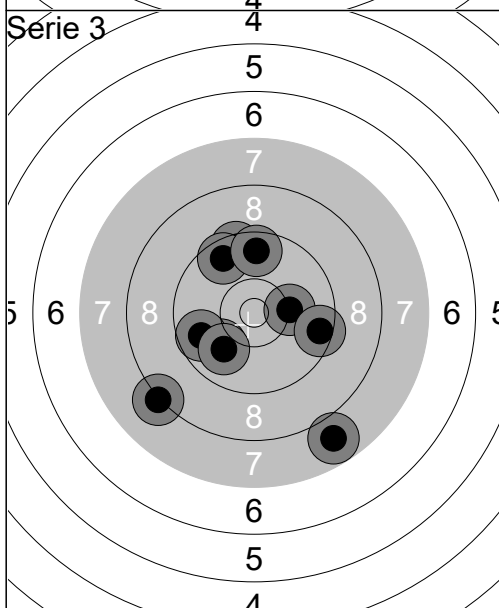

1: 8.2 ↙
 2: 10.0 ↙
 3: 9.5 ↑
 4: 10.2 →
 5: 9.6 ↗
 6: 9.6 ↑
 7: 9.7 ↙
 8: 7.8 ↓
 9: 9.5 →
 10: 9.9 ↙

Serie 89 (0x)

Total 262 (3x)

Serie 4

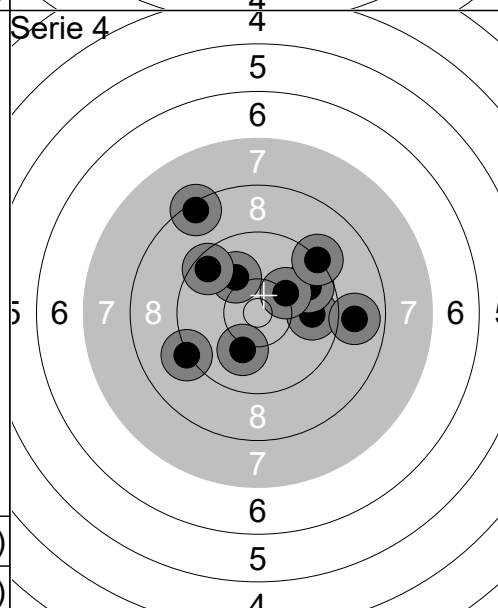

1: 8.4 ↗
 2: 10.1 ↓
 3: 9.2 ↙
 4: 9.8 →
 5: 9.7 ↗
 6: 8.9 →
 7: 10.2 ↗
 8: 9.3 ↗
 9: 10.1 ↗
 10: 9.5 ↙

Serie 91 (0x)

Total 353 (3x)

Serie 5

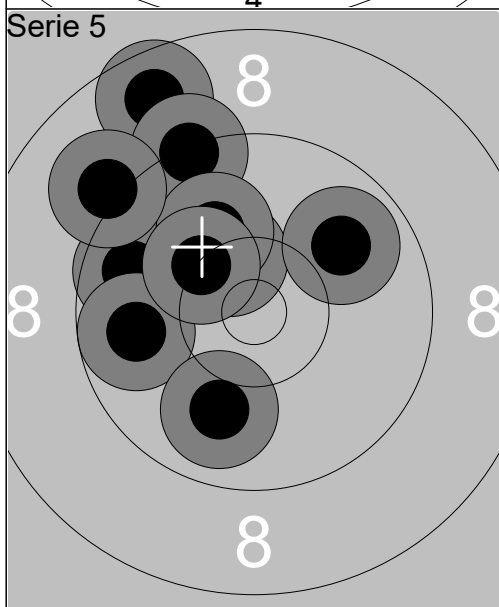

1: 9.7 ↙
 2: 10.4x ↗
 3: 8.7 ↗
 4: 9.3 ↗
 5: 10.1 ↗
 6: 9.8 ↙
 7: 9.9 ↗
 8: 10.0 ↓
 9: 10.3 ↗
 10: 9.1 ↙

Serie 93 (1x)

Total 446 (4x)

Serie 6

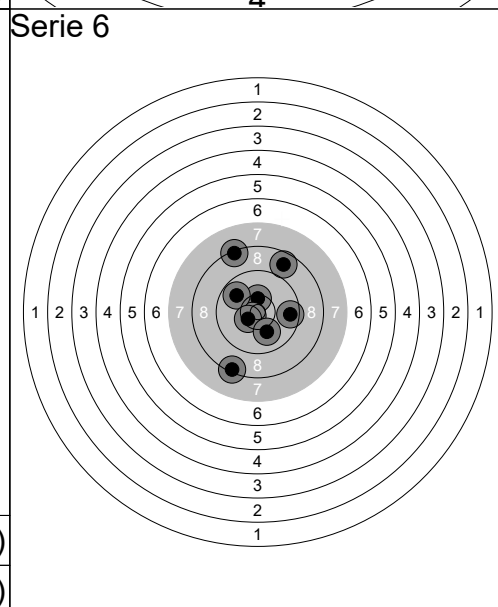

1: 9.6 →
 2: 10.4x ↑
 3: 10.7x ↙
 4: 8.3 ↑
 5: 8.3 ↓
 6: 0.0 ↑
 7: 8.7 ↗
 8: 9.8 ↙
 9: 10.5x ↙
 10: 10.0 ↓

Serie 82 (3x)

Total 528 (7x)

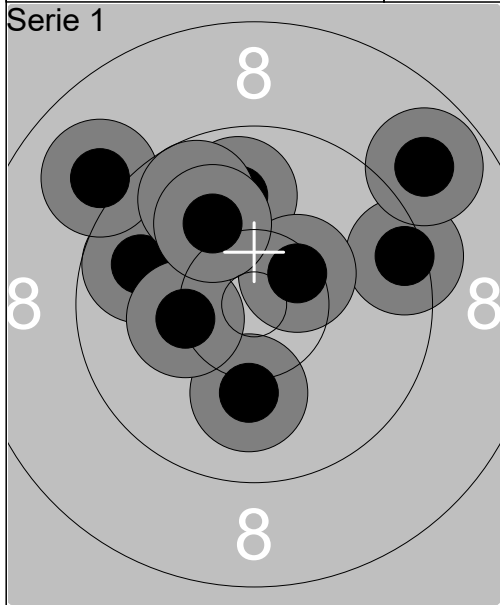

1:	9.8	↖
2:	9.4	→
3:	9.9	↑
4:	9.0	↖
5:	10.4x	↗
6:	10.1	↓
7:	9.8	↗
8:	10.3	←
9:	8.8	↗
10:	10.1	↗
Serie		93 (1x)
Total		93 (1x)

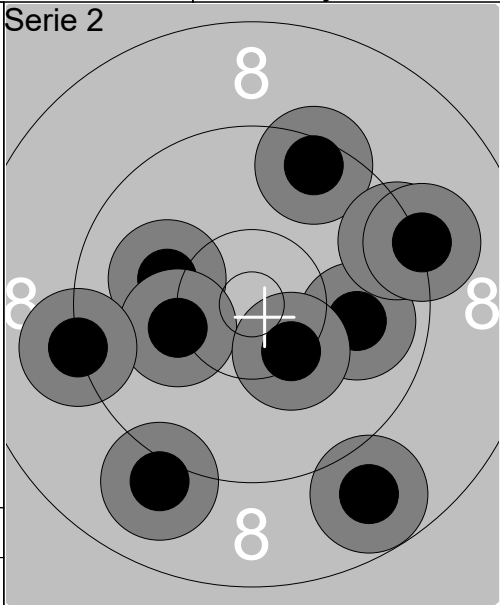

1:	8.8	↘
2:	9.5	↗
3:	9.9	→
4:	10.1	←
5:	10.2	←
6:	9.2	←
7:	10.4x	↘
8:	9.0	↓
9:	9.4	↗
10:	9.2	↗
Serie		92 (1x)
Total		185 (2x)

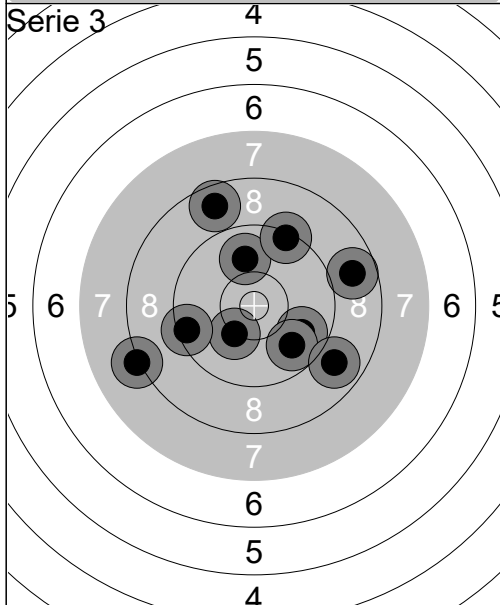

1:	9.8	↘
2:	10.2	↘
3:	9.9	↑
4:	9.8	↘
5:	8.9	↘
6:	8.2	←
7:	8.7	↗
8:	9.3	↗
9:	8.7	→
10:	9.4	←
Serie		87 (0x)
Total		272 (2x)

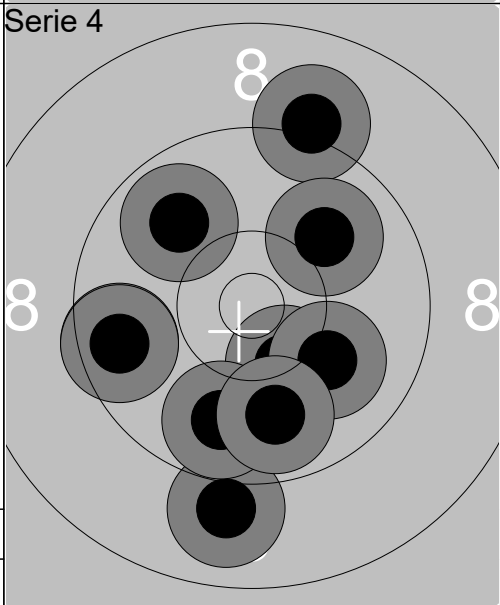

1:	9.1	↗
2:	10.3	↘
3:	9.0	↓
4:	9.6	←
5:	10.0	↘
6:	9.6	←
7:	9.9	↗
8:	10.0	↗
9:	9.8	↓
10:	9.9	↓
Serie		93 (0x)
Total		365 (2x)

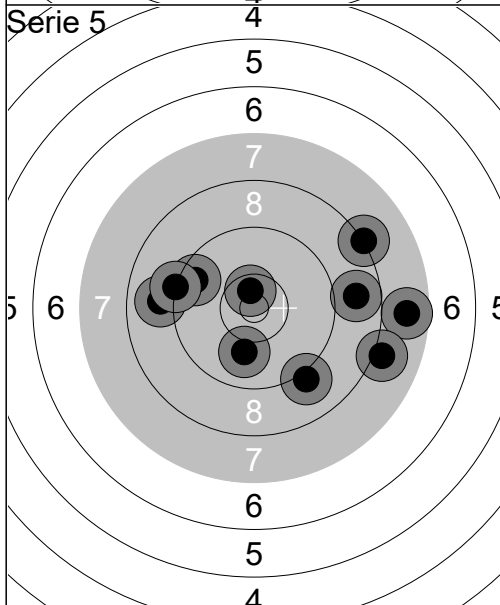

1:	9.6	←
2:	8.8	→
3:	9.0	←
4:	7.7	→
5:	8.2	↗
6:	9.2	←
7:	10.6x	↑
8:	10.0	↓
9:	9.1	↘
10:	8.0	→
Serie		87 (1x)
Total		452 (3x)

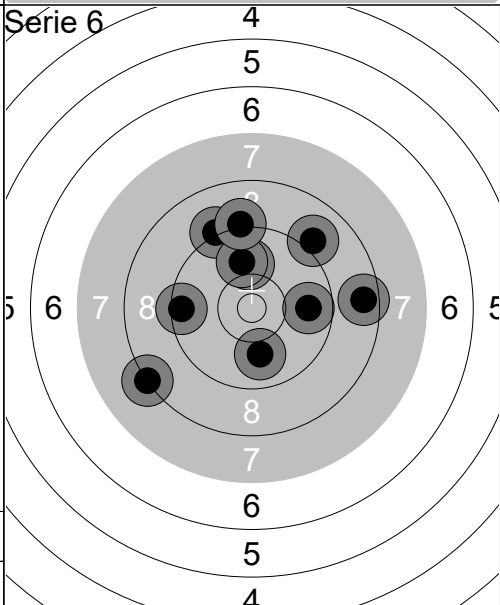

1:	8.2	↖
2:	9.9	↓
3:	10.0	↑
4:	9.5	←
5:	9.0	↗
6:	9.2	↗
7:	9.7	→
8:	9.9	↑
9:	8.6	→
10:	9.1	↑
Serie		89 (0x)
Total		541 (3x)

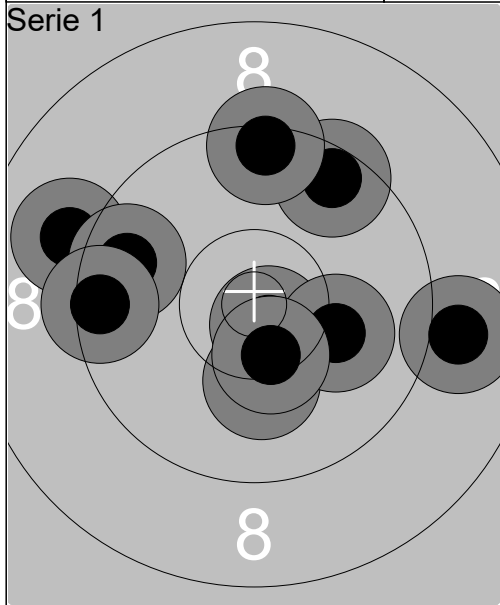

1:	9.5	↗
2:	9.1	↖
3:	9.7	↖
4:	10.7x	↘
5:	10.2	↓
6:	9.5	↖
7:	10.1	→
8:	9.4	↑
9:	9.0	→
10:	10.4x	↘
Serie		94 (2x)
Total		94 (2x)

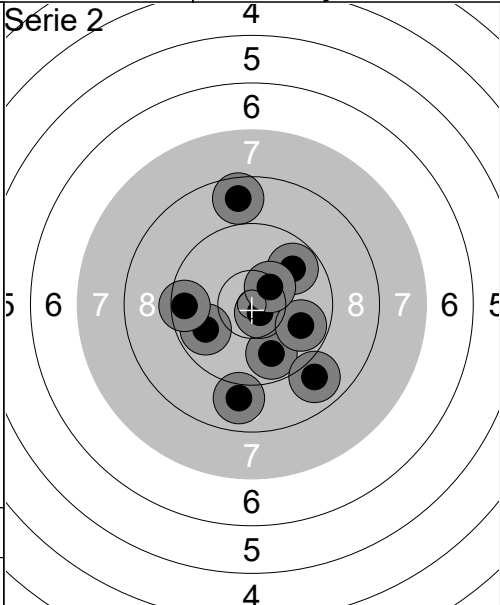

1:	9.8	↘
2:	9.8	↗
3:	9.8	↖
4:	10.7x	↘
5:	8.9	↓
6:	9.5	↖
7:	9.8	→
8:	8.9	↘
9:	10.4x	↗
10:	8.7	↑
Serie		89 (2x)
Total		183 (4x)

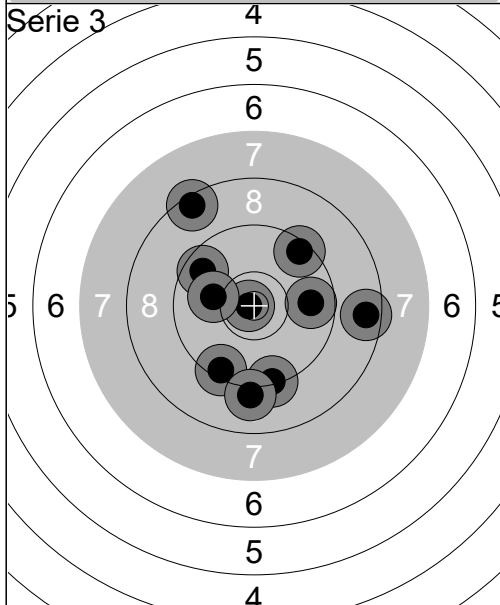

1:	9.4	↘
2:	8.4	↗
3:	10.8x	↖
4:	9.4	↗
5:	9.7	→
6:	8.6	→
7:	9.3	↘
8:	9.6	↗
9:	10.1	↖
10:	9.0	↓
Serie		90 (1x)
Total		273 (5x)

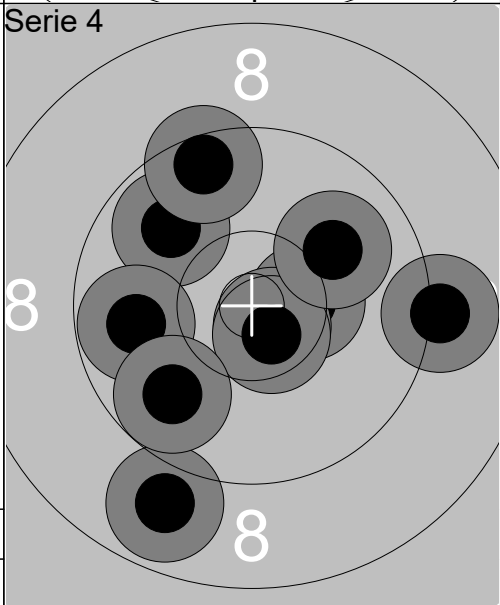

1:	9.9	↗
2:	10.4x	→
3:	9.1	→
4:	9.5	↑
5:	9.8	↖
6:	10.7x	↘
7:	10.6x	↘
8:	10.0	↗
9:	8.9	↘
10:	9.8	↘
Serie		93 (3x)
Total		366 (8x)

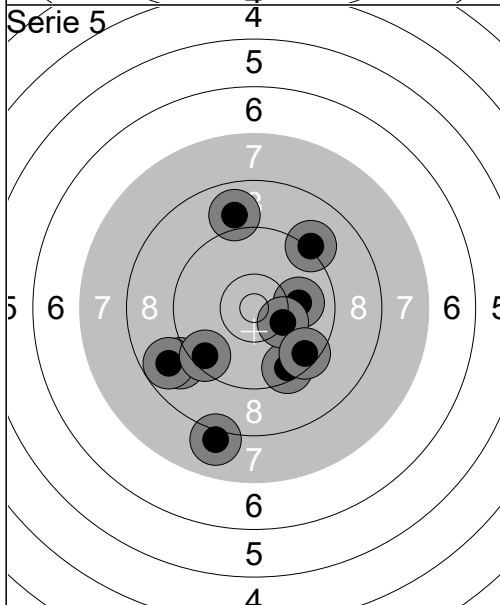

1:	8.0	↘
2:	8.9	↑
3:	9.5	↘
4:	9.0	↖
5:	10.0	→
6:	8.8	↖
7:	10.3	→
8:	9.5	↘
9:	9.5	↖
10:	9.2	↗
Serie		89 (0x)
Total		455 (8x)

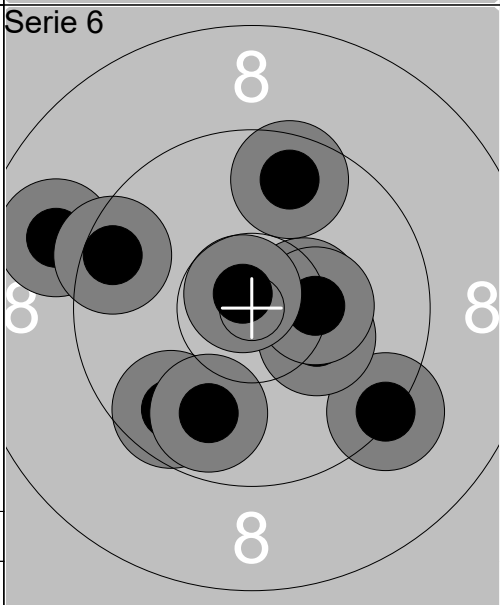

1:	8.9	↖
2:	9.7	↘
3:	9.3	↘
4:	10.4x	→
5:	10.3	→
6:	9.8	↘
7:	10.3	→
8:	9.5	↖
9:	10.8x	↗
10:	9.7	↑
Serie		93 (2x)
Total		548 (10x)