

1:	10.3	↗
2:	9.5	↖
3:	9.9	→
4:	9.8	↗
5:	9.8	→
6:	9.3	↑
7:	10.5x	↘
8:	10.5x	↘
9:	10.8x	↑
10:	10.8x	→
Serie		95 (4x)
Total		95 (4x)

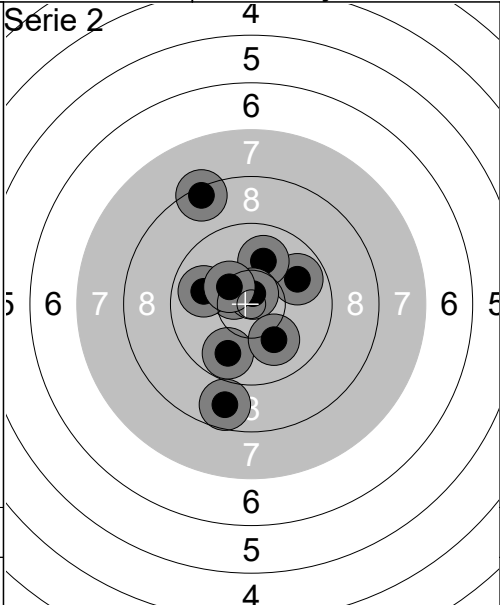

1:	9.8	↗
2:	10.5x	↖
3:	8.7	↓
4:	9.9	↖
5:	10.0	↑
6:	10.7x	↑
7:	10.4	↖
8:	8.4	↑
9:	9.8	↓
10:	10.0	↓
Serie		93 (2x)
Total		188 (6x)

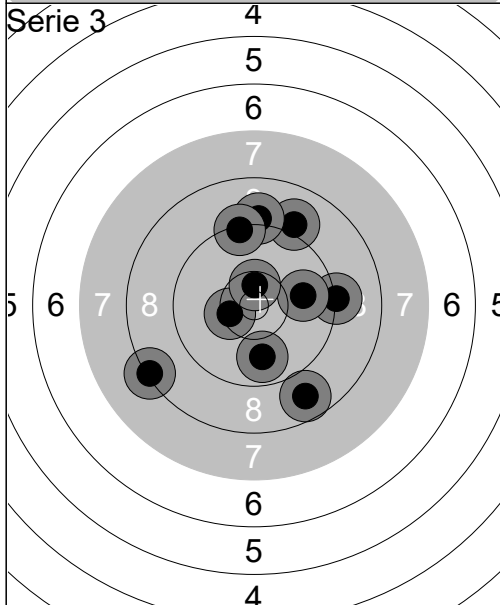

1:	9.2	→
2:	9.0	↗
3:	8.3	↖
4:	10.4x	↖
5:	9.9	→
6:	9.1	↑
7:	9.3	↑
8:	8.7	↓
9:	10.5x	↑
10:	9.8	↓
Serie		90 (2x)
Total		278 (8x)

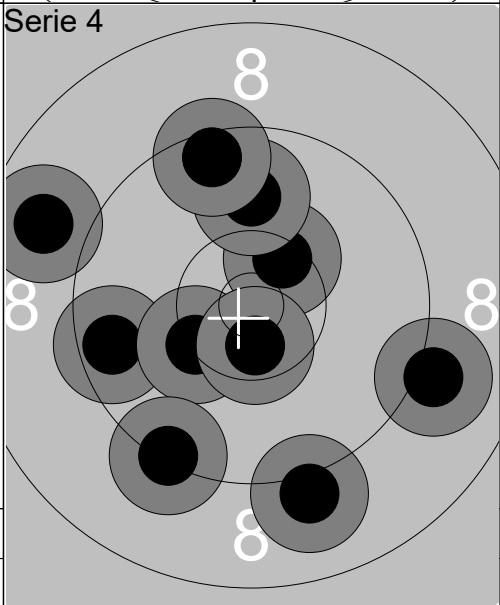

1:	9.6	↖
2:	10.3	↖
3:	8.8	↖
4:	10.4x	↗
5:	9.3	↘
6:	9.1	→
7:	10.6x	↓
8:	9.0	↓
9:	9.9	↑
10:	9.5	↑
Serie		92 (2x)
Total		370 (10x)

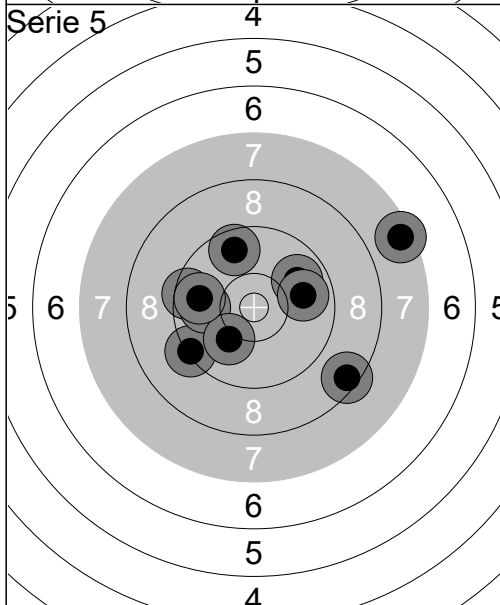

1:	9.3	↖
2:	9.5	↖
3:	9.9	↗
4:	8.5	↘
5:	9.9	↖
6:	9.7	↑
7:	10.1	↘
8:	9.9	→
9:	9.8	↖
10:	7.5	→
Serie		88 (0x)
Total		458 (10x)

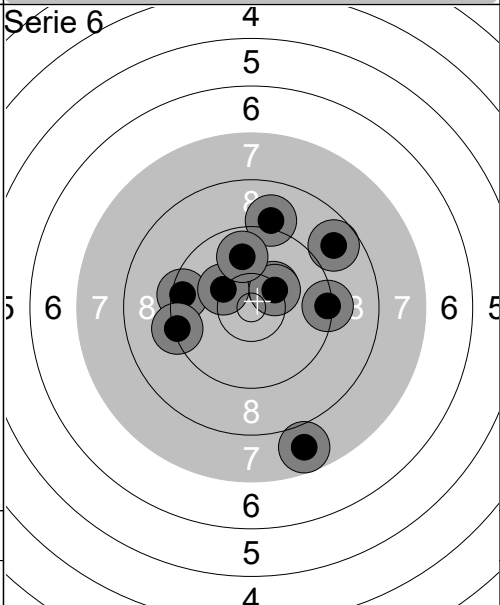

1:	9.5	↖
2:	9.1	↑
3:	10.3	↗
4:	7.8	↓
5:	10.2	↖
6:	9.3	→
7:	8.8	↗
8:	10.3	↗
9:	9.3	↖
10:	9.8	↑
Serie		90 (0x)
Total		548 (10x)

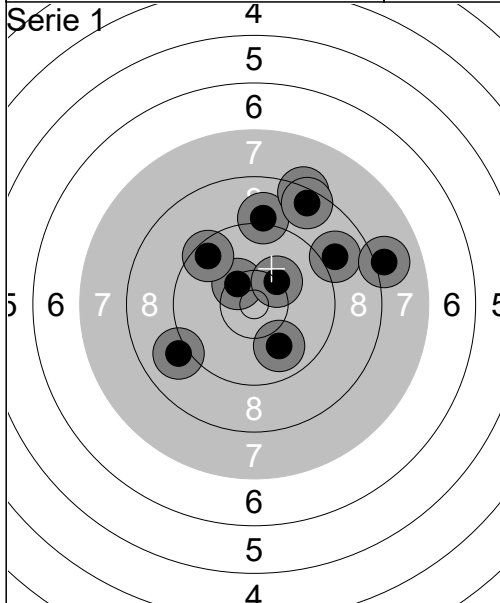

1:	9.1	↑
2:	8.9	→
3:	8.3	↑
4:	9.9	↓
5:	8.0	→
6:	9.0	←
7:	10.4x	↖
8:	9.5	↖
9:	8.5	↑
10:	10.3	↗
Serie		88 (1x)
Total		88 (1x)

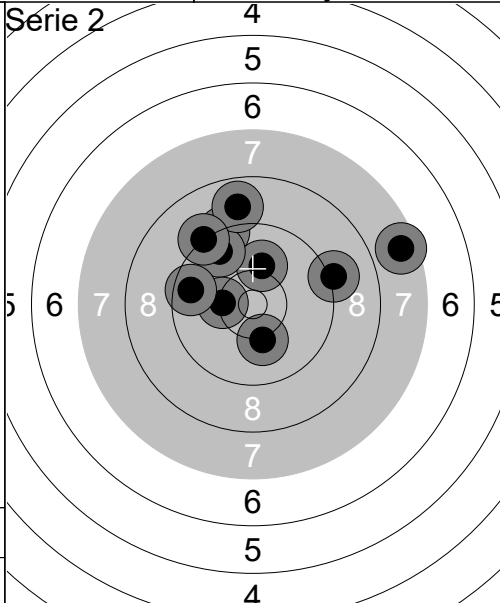

1:	9.3	↖
2:	10.1	↑
3:	9.6	↖
4:	9.1	→
5:	10.2	↓
6:	10.3	←
7:	8.8	↑
8:	9.2	↖
9:	7.6	→
10:	9.6	←
Serie		90 (0x)
Total		178 (1x)

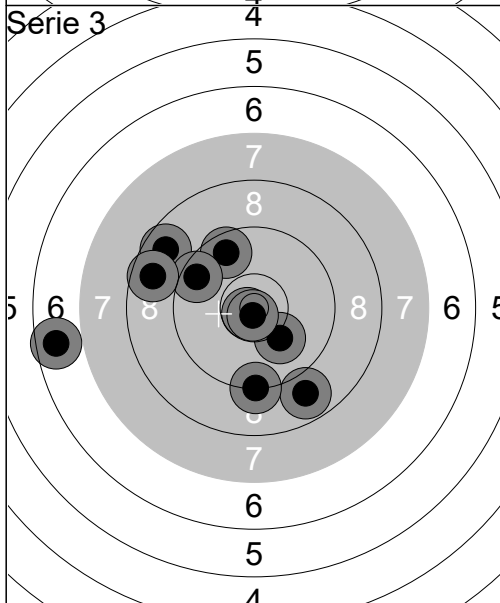

1:	8.7	↖
2:	8.8	↓
3:	6.7	←
4:	10.8x	↖
5:	9.6	↑
6:	9.6	↖
7:	10.1	↓
8:	9.2	↓
9:	8.7	←
10:	10.8x	↓
Serie		87 (2x)
Total		265 (3x)

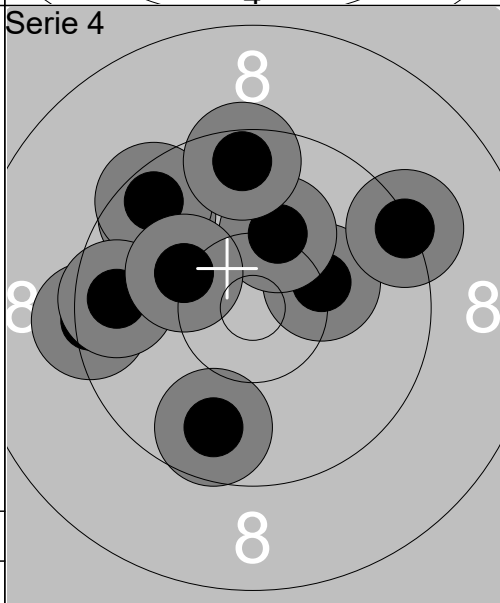

1:	9.7	↖
2:	10.2	→
3:	9.5	↖
4:	9.7	↓
5:	10.2	↑
6:	9.4	←
7:	9.3	↗
8:	9.6	←
9:	10.2	↖
10:	9.5	↑
Serie		93 (0x)
Total		358 (3x)

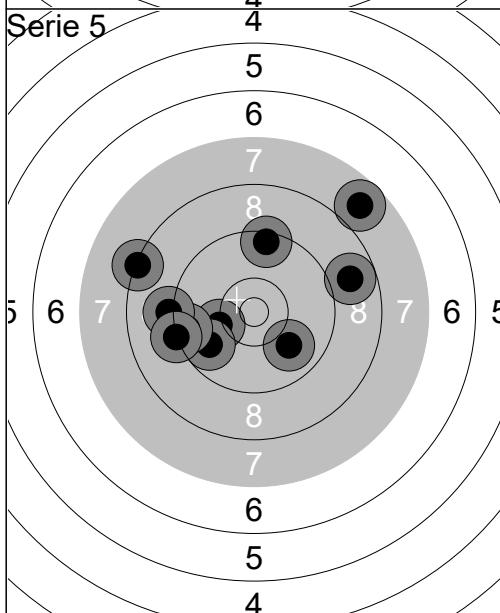

1:	10.2	←
2:	7.7	↗
3:	8.3	←
4:	9.8	←
5:	9.5	←
6:	8.8	→
7:	9.1	←
8:	9.2	←
9:	9.4	↑
10:	9.9	↓
Serie		87 (0x)
Total		445 (3x)

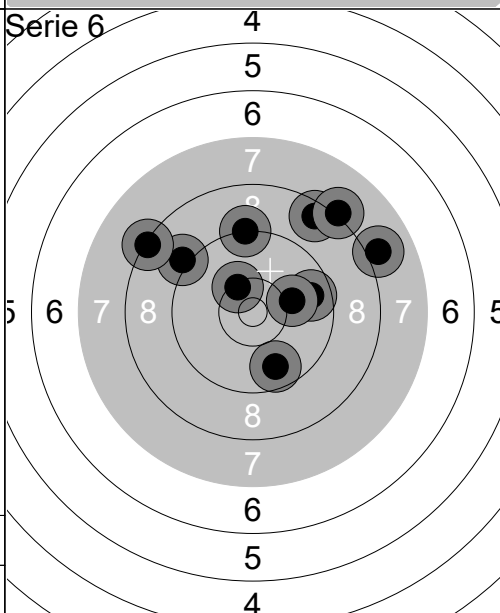

1:	9.2	↑
2:	8.0	→
3:	9.1	↖
4:	8.5	↗
5:	9.7	→
6:	8.3	←
7:	10.3	↖
8:	10.1	→
9:	8.2	↗
10:	9.7	↓
Serie		88 (0x)
Total		533 (3x)

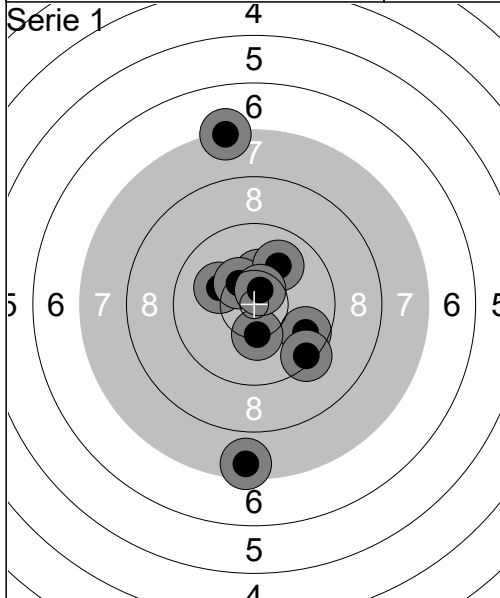

1:	9.7	↘
2:	7.3	↑
3:	10.3	↑
4:	10.1	↖
5:	10.3	↓
6:	10.4x	↗
7:	9.4	↘
8:	7.5	↓
9:	10.0	↗
10:	10.6x	↑
Serie		92 (2x)
Total		92 (2x)

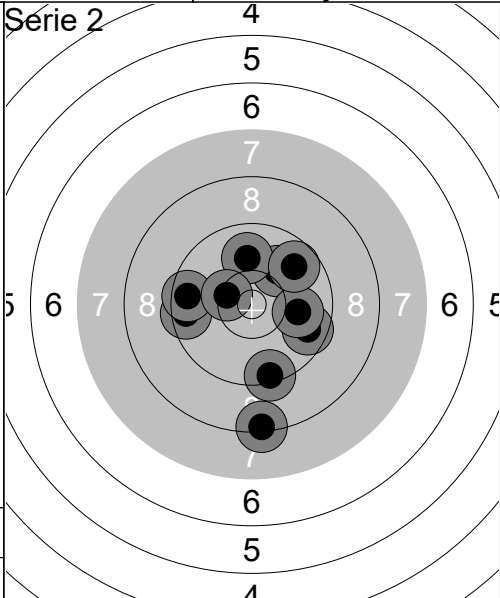

1:	9.5	↖
2:	9.6	↗
3:	10.1	↗
4:	8.3	↓
5:	9.4	↓
6:	9.9	↗
7:	9.6	↖
8:	10.0	↑
9:	10.4x	↖
10:	9.7	↗
Serie		92 (1x)
Total		184 (3x)

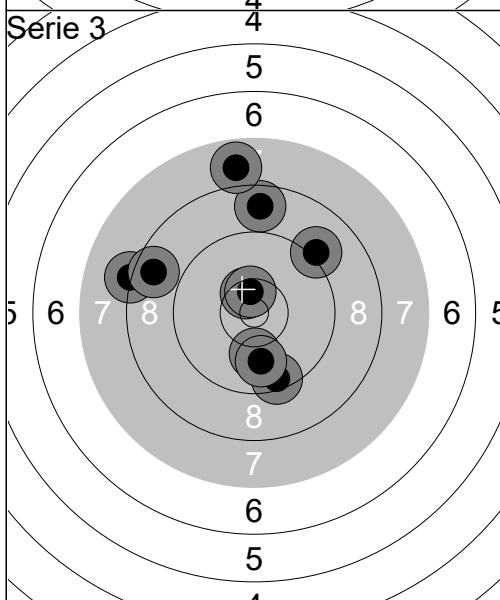

1:	10.5x	↗
2:	9.5	↓
3:	10.1	↓
4:	8.7	↑
5:	9.9	↓
6:	8.2	↖
7:	7.8	↑
8:	9.1	↗
9:	8.6	↖
10:	10.5x	↑
Serie		88 (2x)
Total		272 (5x)

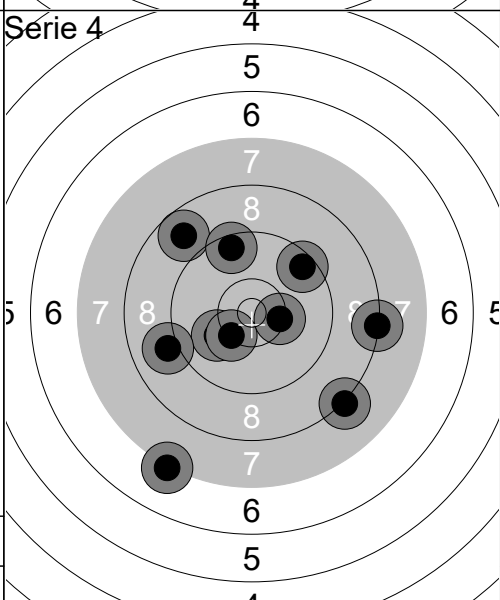

1:	9.5	↗
2:	8.3	↗
3:	10.1	↖
4:	8.2	↘
5:	9.0	↖
6:	10.3	↖
7:	8.8	↗
8:	7.2	↓
9:	10.3	↗
10:	9.5	↑
Serie		88 (0x)
Total		360 (5x)

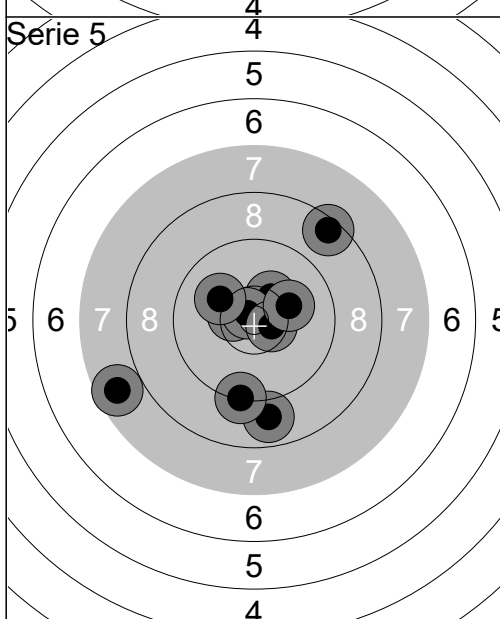

1:	10.3	↗
2:	10.5x	↖
3:	8.9	↓
4:	10.8x	↖
5:	7.7	↖
6:	10.6x	↗
7:	10.1	↖
8:	9.3	↓
9:	8.5	↗
10:	10.1	↗
Serie		92 (3x)
Total		452 (8x)

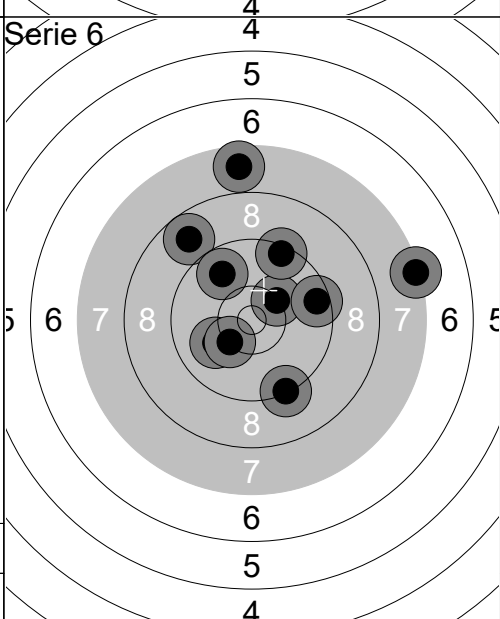

1:	8.8	↖
2:	7.7	↑
3:	7.3	↗
4:	9.3	↓
5:	10.3	↗
6:	10.0	↖
7:	9.4	↑
8:	9.8	↗
9:	10.3	↖
10:	9.5	↗
Serie		88 (0x)
Total		540 (8x)

Luftpistol

Rundviks Pistolskytteklubb

H/D 70

10.01.2025

Vinterträffen 2025

Umeå skytteallians

Serie 1

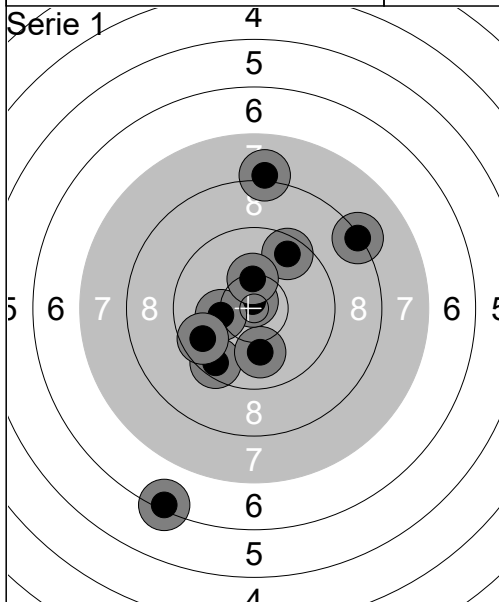

1: 9.5 ↙
 2: 10.0 ↓
 3: 10.8x ↑
 4: 10.2 ←
 5: 9.7 ←
 6: 9.6 ↗
 7: 10.3 ↑
 8: 8.3 ↗
 9: 6.3 ↓
 10: 8.1 ↑

Serie 89 (1x)

Total 89 (1x)

Serie 2

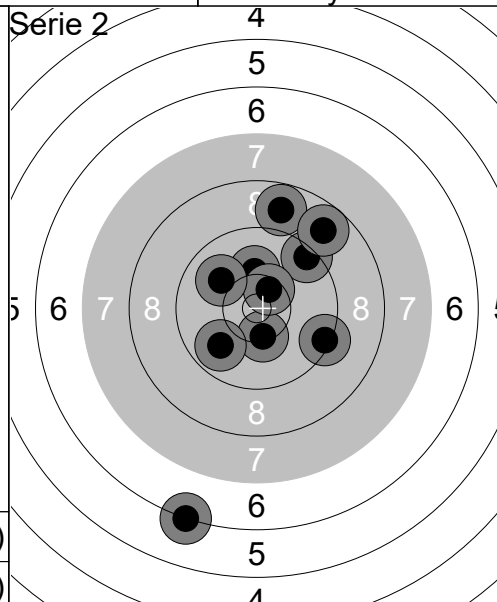

1: 9.3 →
 2: 9.4 ↗
 3: 6.2 ↓
 4: 10.3 ↓
 5: 10.2 ↑
 6: 10.5x ↗
 7: 8.8 ↑
 8: 9.8 ↙
 9: 10.0 ↖
 10: 8.8 ↗

Serie 89 (1x)

Total 178 (2x)

Serie 3

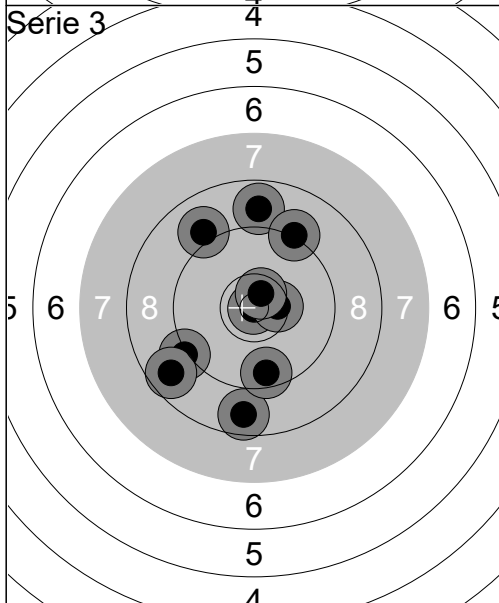

1: 10.9x ↙
 2: 10.4x →
 3: 8.8 ↑
 4: 9.2 ↙
 5: 9.2 ↗
 6: 8.7 ↙
 7: 8.7 ↓
 8: 10.6x ↑
 9: 9.0 ↖
 10: 9.5 ↓

Serie 90 (3x)

Total 268 (5x)

Serie 4

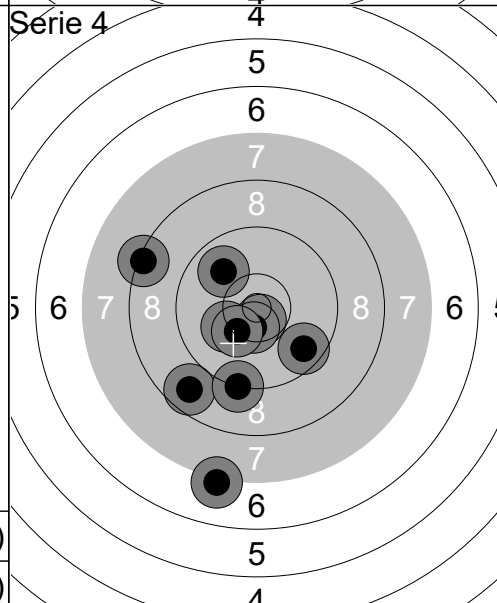

1: 9.6 ↘
 2: 10.2 ↙
 3: 8.3 ←
 4: 10.7x ↓
 5: 7.1 ↓
 6: 8.7 ↙
 7: 10.5x ↓
 8: 10.3 ↙
 9: 9.2 ↓
 10: 9.9 ↖

Serie 90 (2x)

Total 358 (7x)

Serie 5

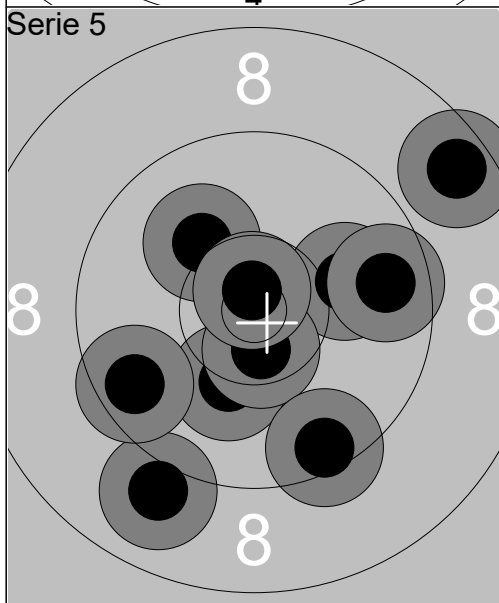

1: 10.2 ↓
 2: 10.1 ↖
 3: 10.0 →
 4: 10.6x ↓
 5: 9.4 ↓
 6: 9.6 →
 7: 8.6 ↗
 8: 9.0 ↓
 9: 9.6 ←
 10: 10.7x ↑

Serie 94 (2x)

Total 452 (9x)

Serie 6

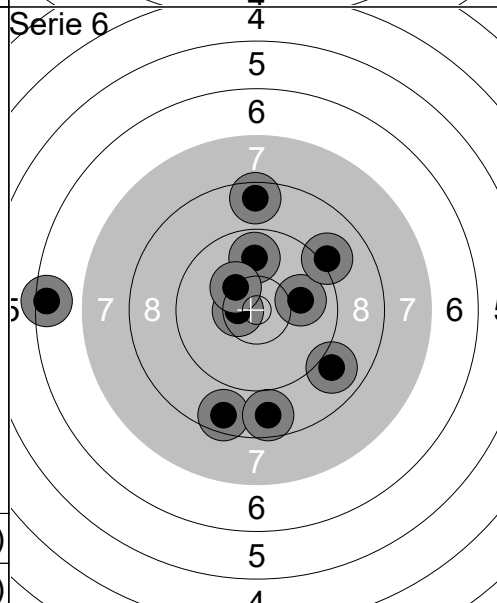

1: 10.0 →
 2: 8.6 ↓
 3: 8.6 ↑
 4: 10.5x ←
 5: 9.1 ↗
 6: 9.8 ↑
 7: 10.3 ↖
 8: 6.5 ←
 9: 8.9 ↘
 10: 8.7 ↓

Serie 86 (1x)

Total 538 (10x)

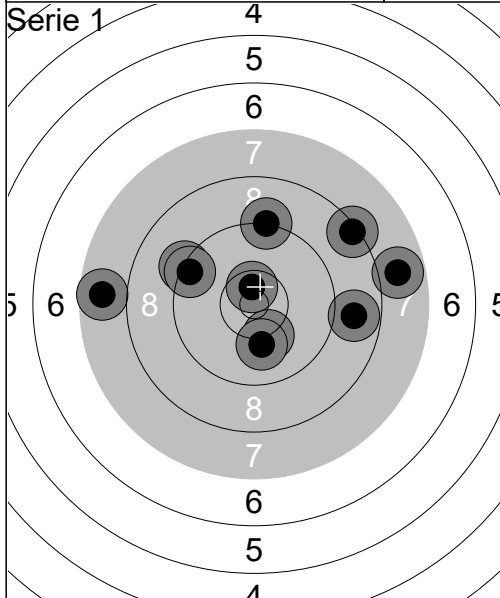

1:	9.3	↖
2:	9.2	↑
3:	7.7	←
4:	10.2	↓
5:	9.4	↖
6:	8.8	→
7:	8.3	↗
8:	10.1	↓
9:	7.8	→
10:	10.6x	↑
Serie		87 (1x)
Total		87 (1x)

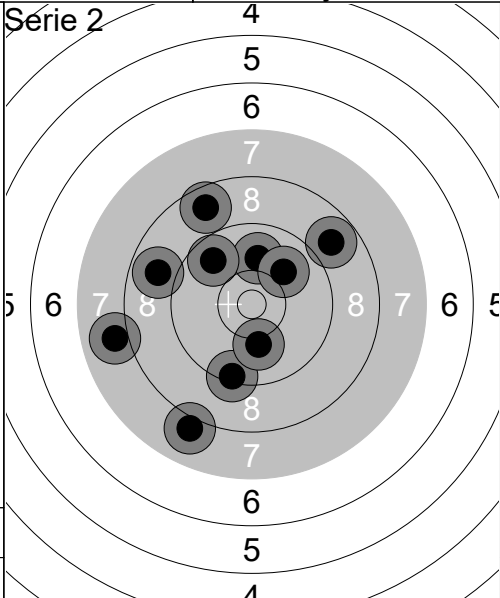

1:	9.4	↓
2:	8.8	↖
3:	8.7	↗
4:	10.1	↓
5:	10.0	↑
6:	10.0	↗
7:	8.8	↗
8:	7.9	←
9:	9.7	↖
10:	8.0	↓
Serie		87 (0x)
Total		174 (1x)

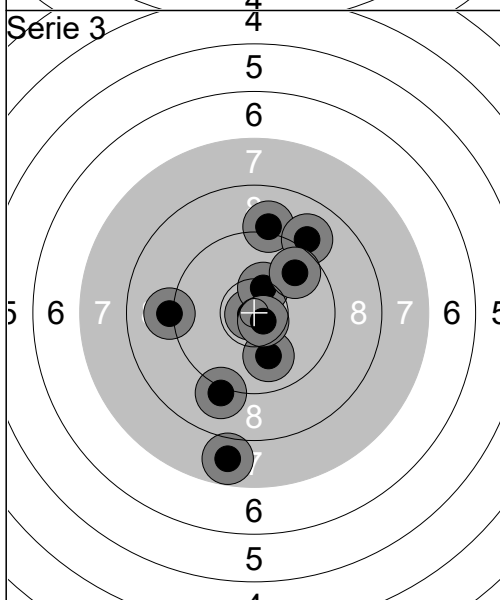

1:	7.8	↓
2:	9.1	↓
3:	9.1	↑
4:	10.0	↓
5:	9.0	↗
6:	10.8x	←
7:	10.4x	↗
8:	9.1	←
9:	10.7x	↘
10:	9.7	↗
Serie		92 (3x)
Total		266 (4x)

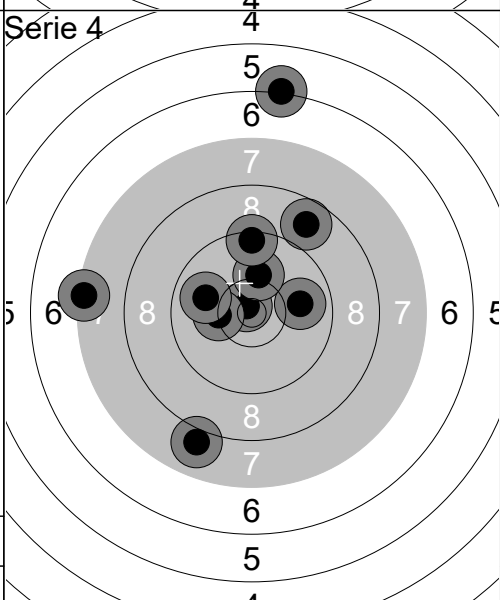

1:	7.4	←
2:	10.8x	↖
3:	10.2	←
4:	8.0	↓
5:	9.9	→
6:	10.1	↑
7:	9.9	←
8:	9.4	↑
9:	6.2	↑
10:	8.7	↗
Serie		86 (1x)
Total		352 (5x)

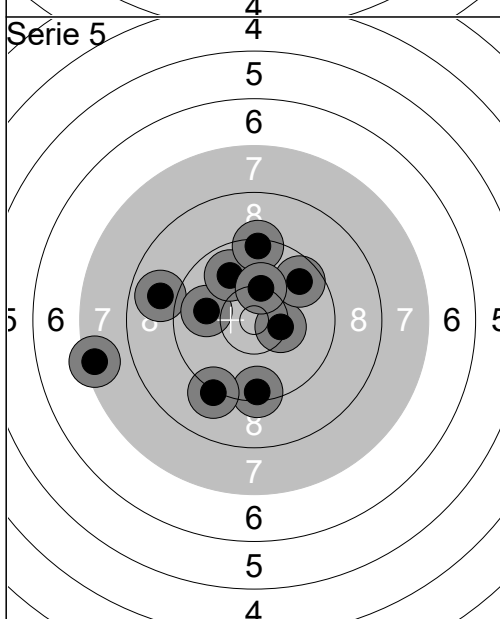

1:	10.4x	→
2:	7.4	←
3:	8.9	←
4:	9.4	↓
5:	9.9	←
6:	9.9	↗
7:	9.7	↗
8:	9.4	↑
9:	10.3	↑
10:	9.2	↓
Serie		89 (1x)
Total		441 (6x)

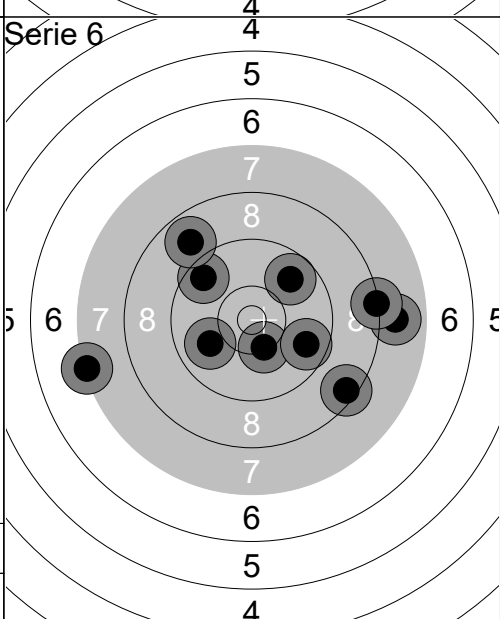

1:	9.6	↖
2:	8.8	↗
3:	7.9	→
4:	10.3	↓
5:	8.4	↘
6:	7.3	←
7:	8.3	→
8:	9.7	↘
9:	9.8	↗
10:	9.9	←
Serie		84 (0x)
Total		525 (6x)

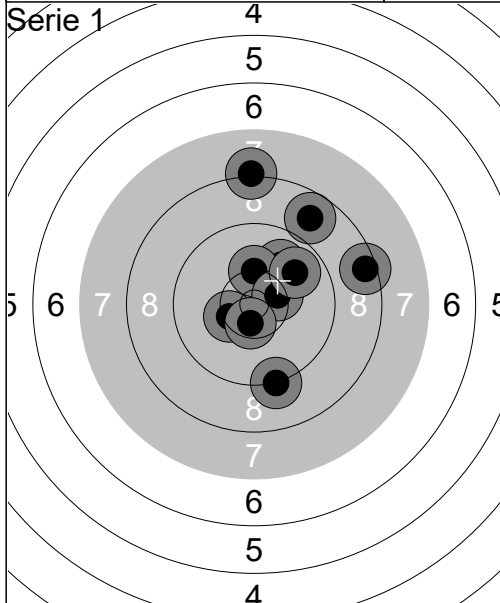

1:	9.9	↗
2:	8.5	→
3:	10.3	↖
4:	10.2	↑
5:	9.2	↓
6:	10.4x	→
7:	10.5x	↓
8:	8.8	↗
9:	8.2	↑
10:	9.8	↗
Serie		91 (2x)
Total		91 (2x)

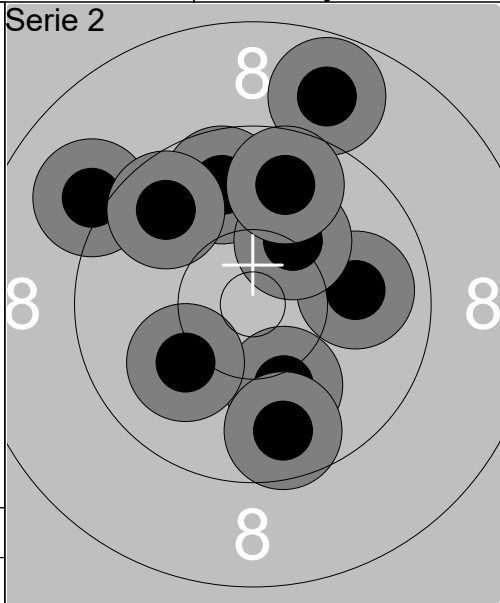

1:	10.1	↓
2:	9.8	↑
3:	9.9	→
4:	8.8	↑
5:	10.1	↖
6:	10.2	↗
7:	9.7	↓
8:	9.8	↑
9:	9.1	↖
10:	9.7	↖
Serie		92 (0x)
Total		183 (2x)

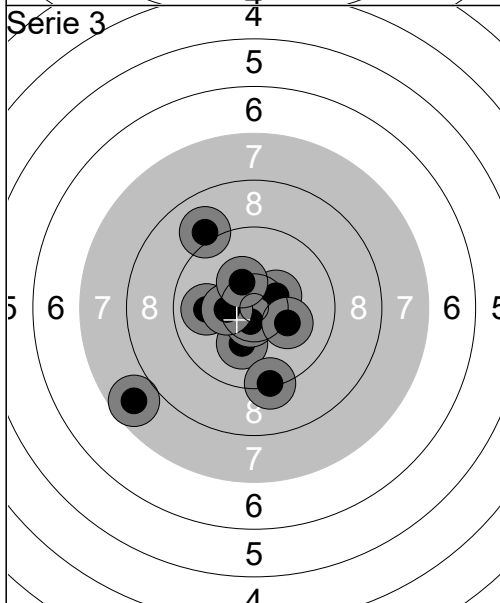

1:	10.1	↓
2:	10.4x	→
3:	10.6x	↓
4:	9.0	↗
5:	9.9	↖
6:	10.4x	↖
7:	10.2	→
8:	7.7	↖
9:	9.3	↓
10:	10.3	↗
Serie		94 (3x)
Total		277 (5x)

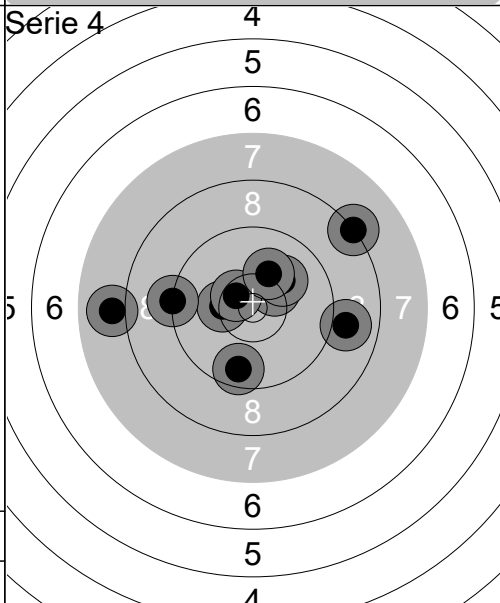

1:	10.3	↖
2:	10.3	↗
3:	9.6	↓
4:	10.1	↗
5:	10.5x	↖
6:	8.9	→
7:	8.2	↗
8:	9.2	↖
9:	8.0	↖
10:	10.1	↗
Serie		92 (1x)
Total		369 (6x)

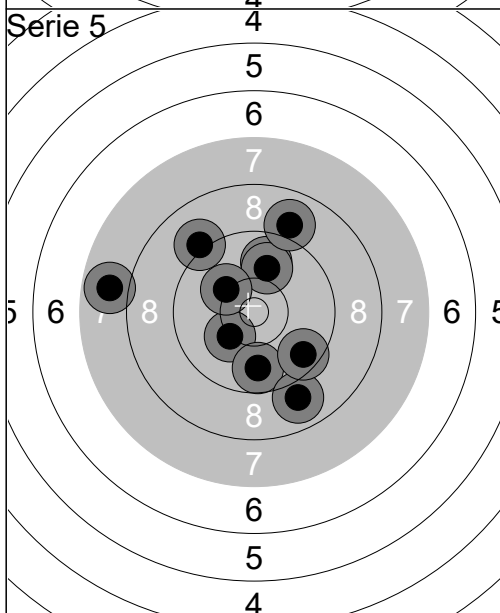

1:	9.1	↖
2:	10.2	↖
3:	9.8	↑
4:	9.8	↓
5:	8.9	↓
6:	10.0	↑
7:	10.2	↖
8:	9.6	↘
9:	7.8	↖
10:	8.9	↑
Serie		89 (0x)
Total		458 (6x)

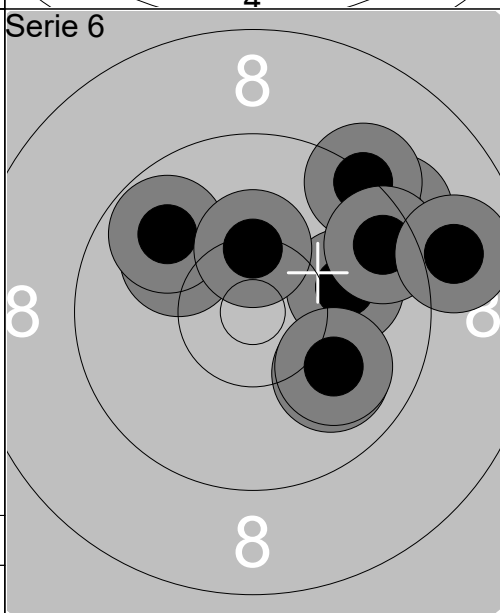

1:	9.3	↗
2:	9.3	↗
3:	10.0	↘
4:	10.0	→
5:	10.1	↖
6:	10.0	↘
7:	9.8	↖
8:	9.5	↗
9:	10.3	↑
10:	8.9	→
Serie		94 (0x)
Total		552 (6x)

Luftpistol

Umeå Pistolskytteklubb

H 1

10.01.2025

Vinterträffen 2025

Umeå skytteallians

Serie 1

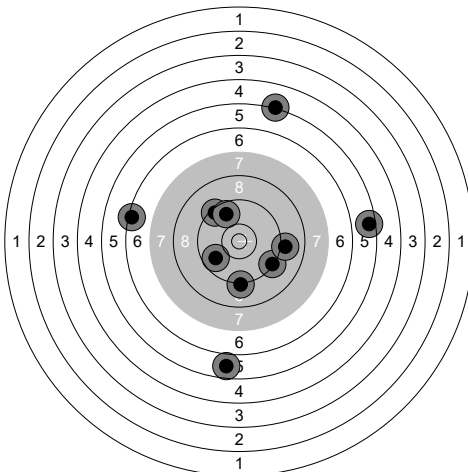

1: 9.2 ↓
 2: 9.7 ↙
 3: 5.2 ↑
 4: 9.4 ↗
 5: 9.3 ↘
 6: 9.7 ↗
 7: 5.7 ↓
 8: 9.0 →
 9: 5.5 →
 10: 6.4 ←

Serie 75 (0x)

Total 75 (0x)

Serie 2

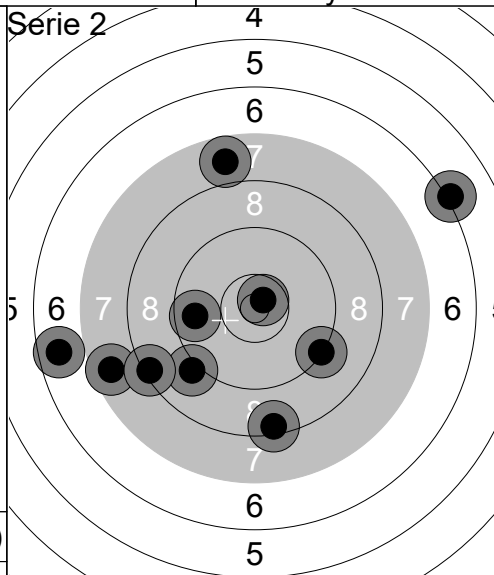

1: 7.6 ←
 2: 10.7x ↗
 3: 8.4 ↓
 4: 9.2 ↘
 5: 9.1 ↙
 6: 6.1 ↗
 7: 6.7 ←
 8: 7.8 ↑
 9: 8.3 ↙
 10: 9.7 ←

Serie 79 (1x)

Total 154 (1x)

Serie 3

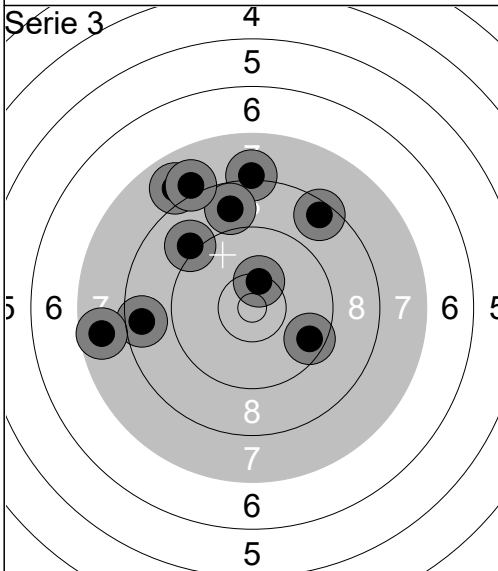

1: 8.5 ↗
 2: 8.6 ←
 3: 10.4x ↑
 4: 9.5 ↘
 5: 9.1 ↗
 6: 7.9 ↗
 7: 7.7 ←
 8: 8.1 ↑
 9: 8.8 ↑
 10: 8.0 ↗

Serie 82 (1x)

Total 236 (2x)

Serie 4

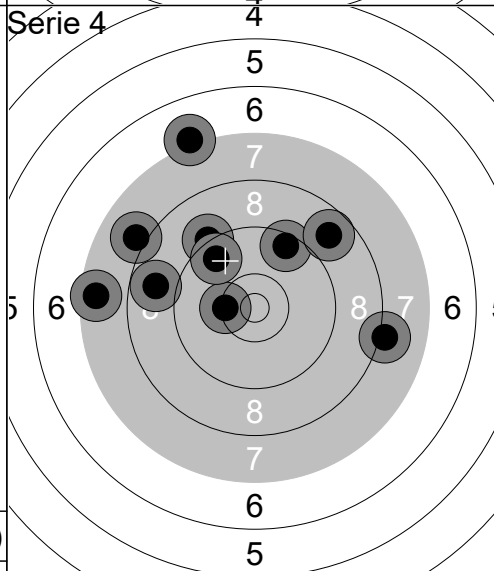

1: 10.3 ←
 2: 8.1 →
 3: 9.5 ↗
 4: 7.6 ←
 5: 8.8 ←
 6: 9.2 ↗
 7: 7.1 ↑
 8: 8.7 ↗
 9: 8.0 ↙
 10: 9.6 ↗

Serie 83 (0x)

Total 319 (2x)

Serie 5

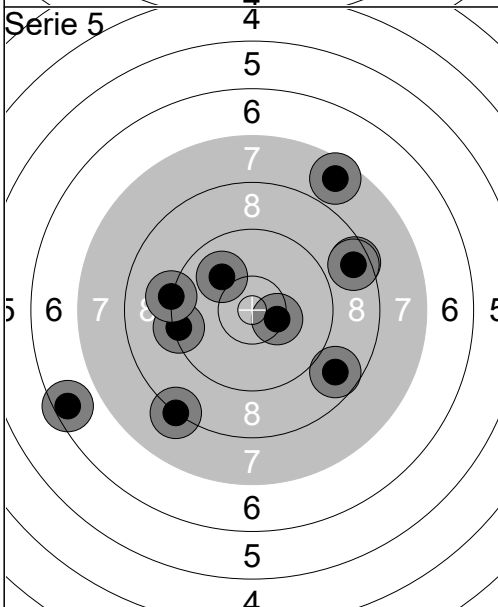

1: 6.5 ←
 2: 8.7 ↘
 3: 10.0 ↗
 4: 7.6 ↗
 5: 9.3 ←
 6: 8.5 →
 7: 9.2 ←
 8: 10.4x →
 9: 8.2 ↙
 10: 8.6 →

Serie 83 (1x)

Total 402 (3x)

Serie 6

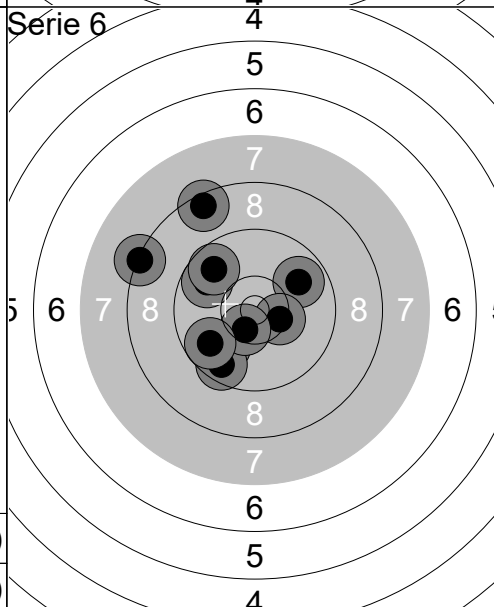

1: 9.8 ↗
 2: 8.5 ↗
 3: 9.7 ↗
 4: 8.3 ←
 5: 9.9 ↙
 6: 9.8 ↗
 7: 10.4x →
 8: 9.6 ↙
 9: 10.5x ↙
 10: 9.8 ↙

Serie 90 (2x)

Total 492 (5x)

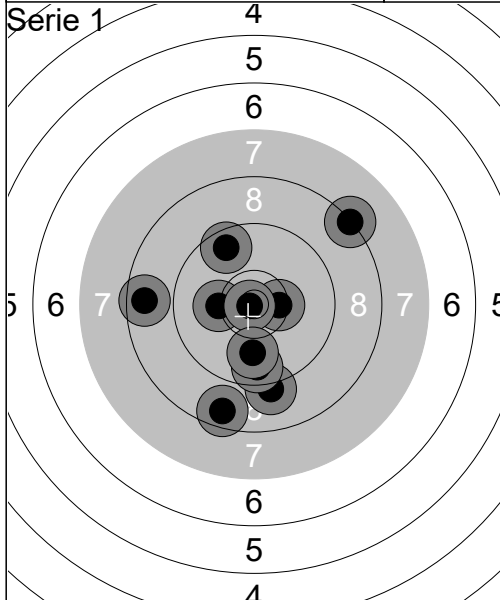

1:	10.2	←
2:	9.6	↖
3:	10.4x	→
4:	8.3	↗
5:	8.6	←
6:	9.1	↓
7:	8.6	↓
8:	10.8x	←
9:	9.6	↓
10:	9.9	↓
Serie		90 (2x)
Total		90 (2x)

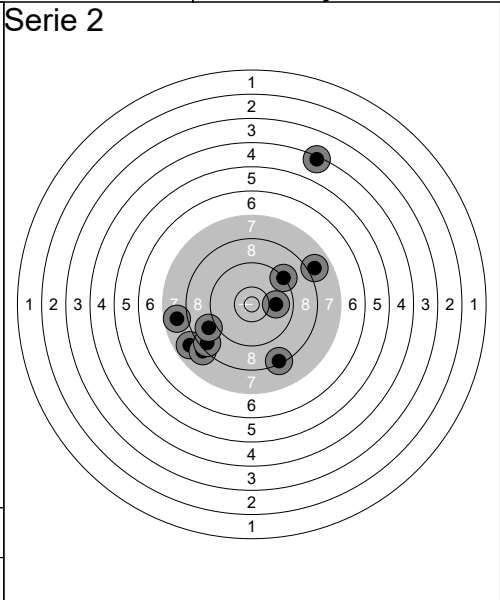

1:	7.9	↙
2:	10.0	→
3:	8.1	↙
4:	7.9	↗
5:	4.4	↗
6:	7.8	←
7:	8.3	↘
8:	9.2	↗
9:	8.5	↙
10:	8.9	↙
Serie		76 (0x)
Total		166 (2x)

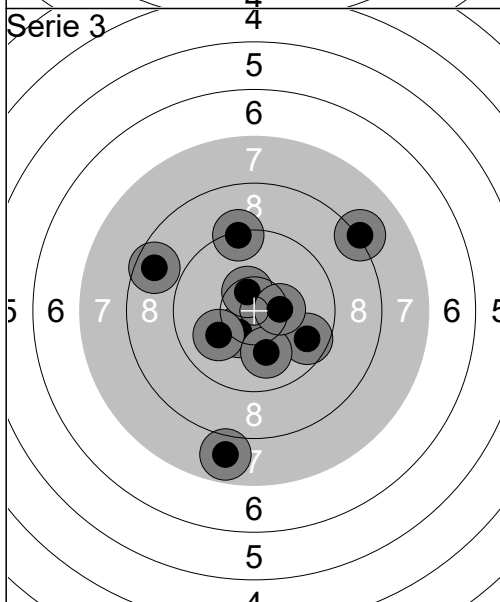

1:	10.4x	↙
2:	10.0	↙
3:	9.7	↗
4:	10.0	↓
5:	10.5x	↗
6:	10.4x	→
7:	8.2	↗
8:	7.8	↓
9:	8.6	←
10:	9.3	↗
Serie		91 (3x)
Total		257 (5x)

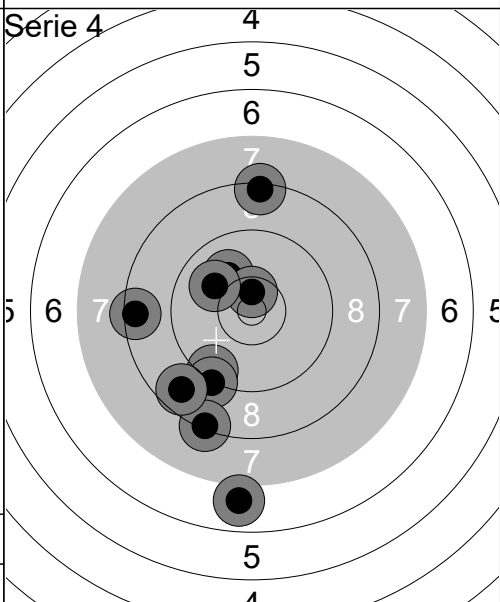

1:	9.4	↙
2:	8.4	↗
3:	10.0	↖
4:	9.2	↘
5:	8.5	←
6:	6.9	↓
7:	8.3	↘
8:	10.5x	↗
9:	10.0	↖
10:	8.7	↘
Serie		86 (1x)
Total		343 (6x)

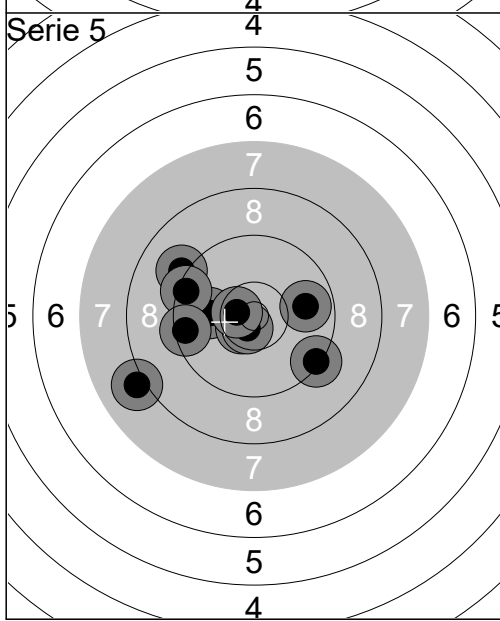

1:	9.8	→
2:	10.0	←
3:	9.3	↘
4:	9.1	↖
5:	10.6x	↙
6:	8.1	←
7:	9.4	←
8:	10.6x	↘
9:	9.5	←
10:	10.6x	←
Serie		93 (3x)
Total		436 (9x)

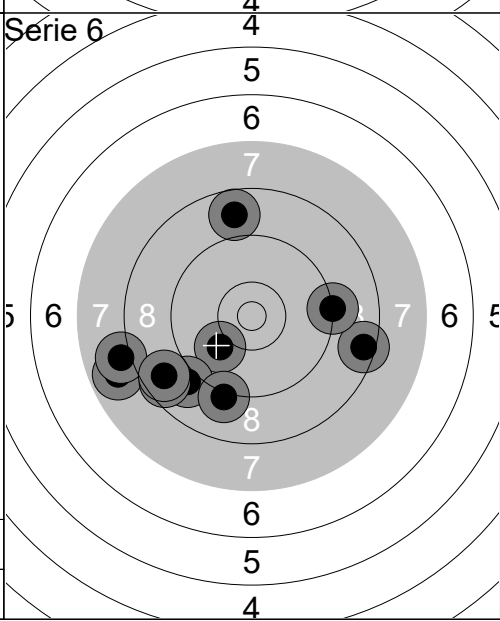

1:	10.0	↙
2:	7.8	←
3:	9.0	↙
4:	9.1	↘
5:	8.0	←
6:	8.8	↗
7:	8.5	→
8:	8.6	↙
9:	8.7	↙
10:	9.2	→
Serie		84 (0x)
Total		520 (9x)

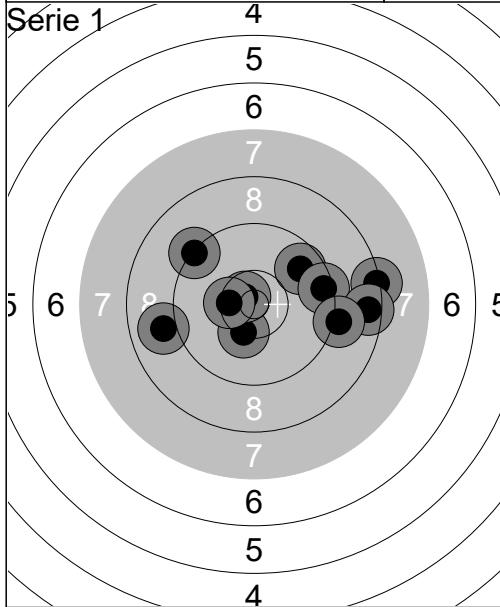

1:	10.3	↘
2:	8.3	→
3:	10.7x	↖
4:	9.7	↗
5:	9.4	→
6:	10.4x	←
7:	8.5	→
8:	9.1	→
9:	8.9	←
10:	9.3	↖
Serie		90 (2x)
Total		90 (2x)

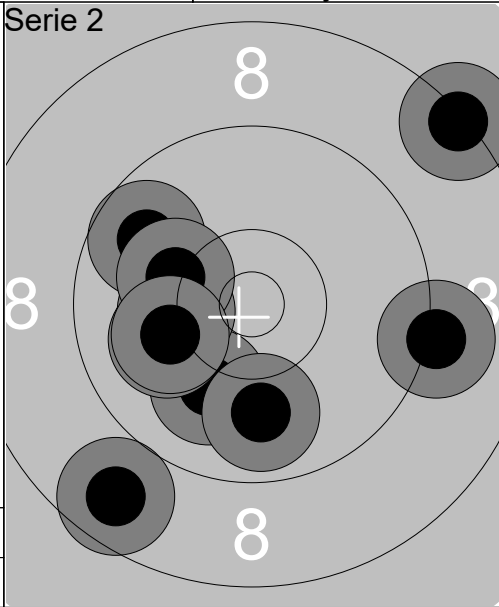

1:	10.1	↘
2:	9.1	→
3:	10.1	↖
4:	8.7	↘
5:	10.2	←
6:	9.9	↓
7:	9.8	↖
8:	10.2	↖
9:	8.3	↗
10:	10.1	←
Serie		93 (0x)
Total		183 (2x)

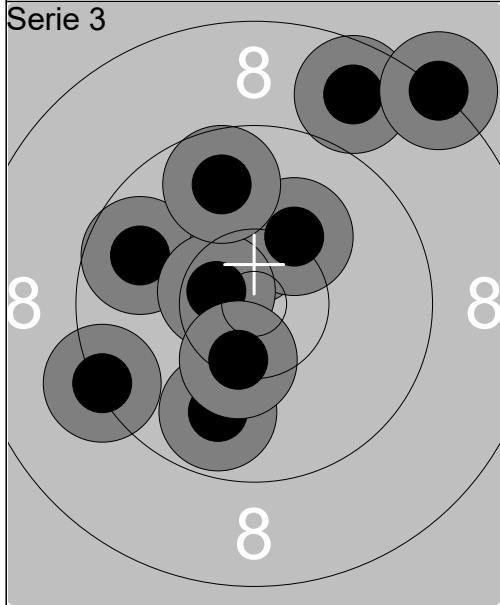

1:	9.9	↘
2:	9.7	↖
3:	8.7	↗
4:	10.4x	↑
5:	9.3	↖
6:	10.2	↗
7:	10.6x	↖
8:	10.4x	↘
9:	9.8	↑
10:	8.2	↗
Serie		92 (3x)
Total		275 (5x)

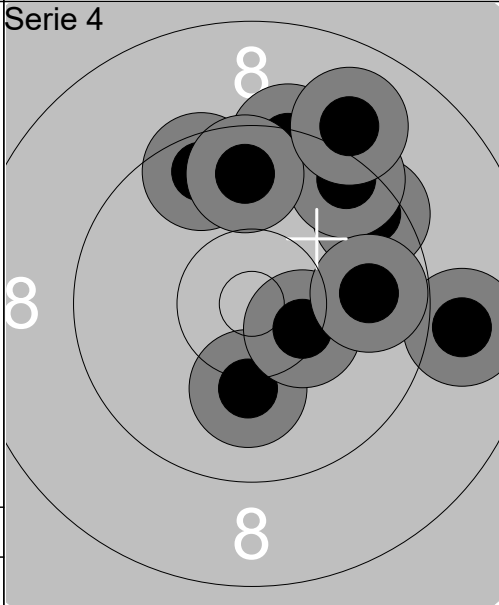

1:	9.5	↗
2:	9.4	↑
3:	9.6	↑
4:	10.1	↓
5:	9.4	↗
6:	8.9	→
7:	10.4x	⇒
8:	9.7	↑
9:	9.0	↗
10:	9.8	→
Serie		91 (1x)
Total		366 (6x)

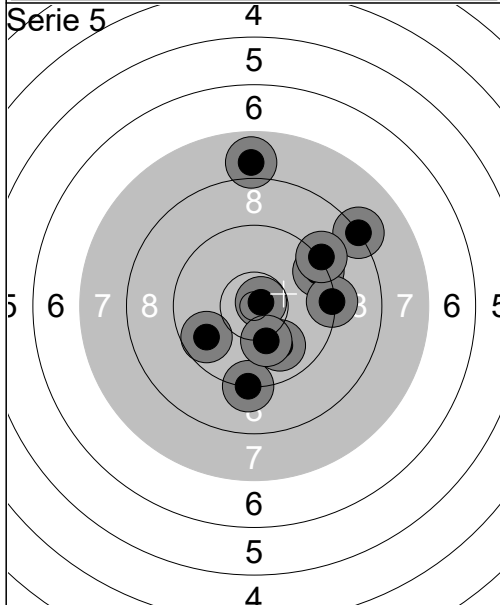

1:	10.8x	↗
2:	8.2	↗
3:	9.2	↓
4:	9.4	↗
5:	9.9	↘
6:	9.3	→
7:	10.2	↘
8:	9.2	↗
9:	7.9	↑
10:	9.7	↖
Serie		89 (1x)
Total		455 (7x)

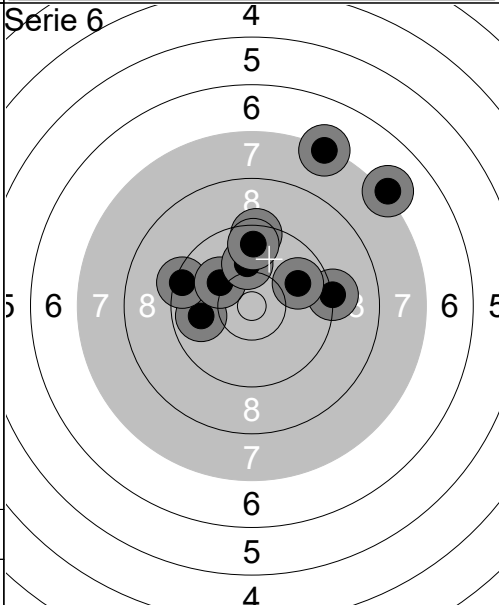

1:	7.2	↗
2:	9.9	←
3:	9.4	↖
4:	9.2	→
5:	10.1	↖
6:	9.4	↑
7:	10.0	↑
8:	7.3	↗
9:	9.6	↑
10:	9.8	↗
Serie		88 (0x)
Total		543 (7x)