

1:	9.3	→
2:	9.7	↑
3:	10.3	→
4:	9.4	↗
5:	10.0	←
6:	9.4	↖
7:	10.5x	→
8:	9.3	↓
9:	10.6x	↑
10:	9.4	↓

Serie	94 (2x)
Total	94 (2x)

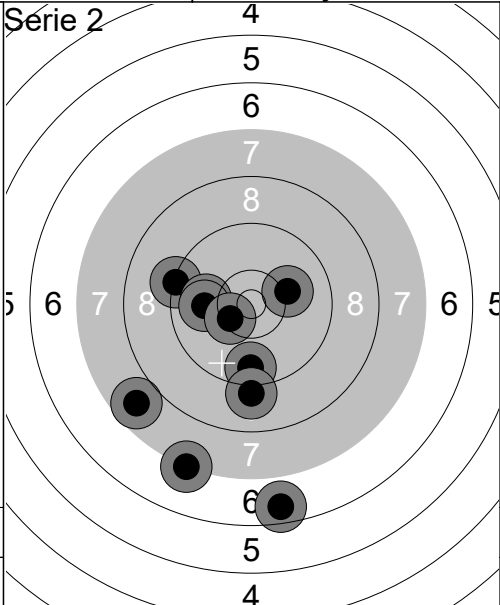

1:	9.3	←
2:	10.1	→
3:	10.0	←
4:	9.6	↓
5:	9.9	←
6:	7.2	↓
7:	10.4x	↙
8:	9.0	↓
9:	7.7	↙
10:	6.6	↓

Serie	86 (1x)
Total	180 (3x)

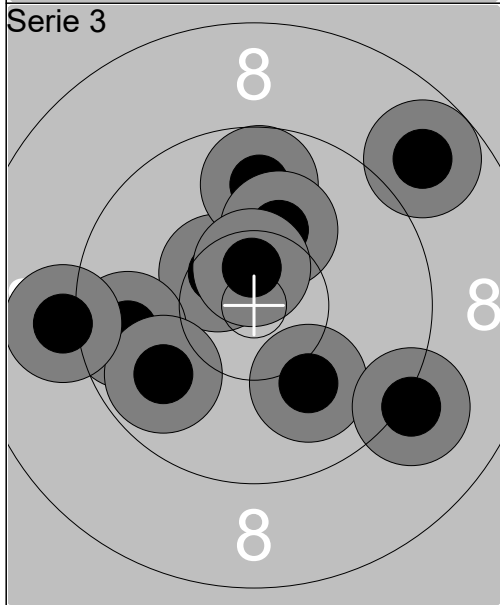

1:	10.5x	↖
2:	9.8	↑
3:	9.7	←
4:	8.8	↗
5:	10.0	↓
6:	9.1	→
7:	10.2	↗
8:	9.8	↙
9:	9.1	←
10:	10.6x	↑

Serie	93 (2x)
Total	273 (5x)

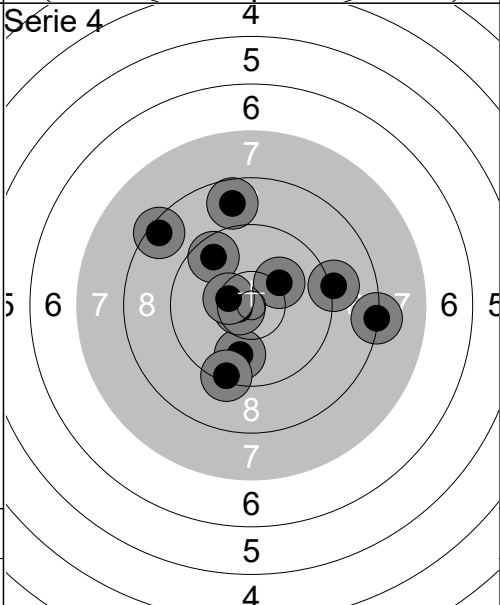

1:	8.3	→
2:	9.9	↓
3:	8.5	↖
4:	10.2	↗
5:	9.6	↖
6:	9.1	→
7:	9.4	↓
8:	10.7x	←
9:	8.7	↑
10:	10.4x	←

Serie	90 (2x)
Total	363 (7x)

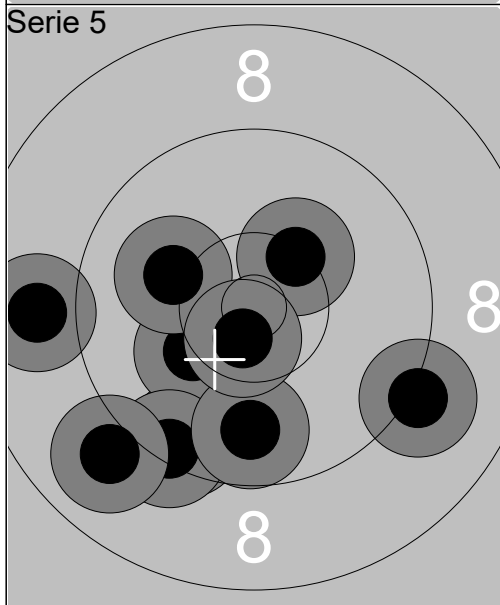

1:	8.9	←
2:	9.5	↓
3:	9.1	→
4:	10.2	↙
5:	10.1	←
6:	10.3	↗
7:	9.4	↓
8:	9.8	↓
9:	9.0	↙
10:	10.6x	↓

Serie	93 (1x)
Total	456 (8x)

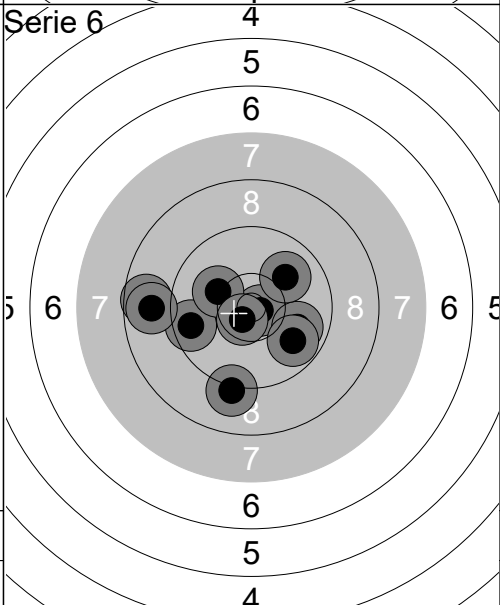

1:	10.7x	→
2:	9.6	←
3:	10.2	↖
4:	9.9	→
5:	10.6x	↙
6:	8.7	←
7:	10.0	↗
8:	9.8	↘
9:	8.8	←
10:	9.1	↓

Serie	92 (2x)
Total	548 (10x)

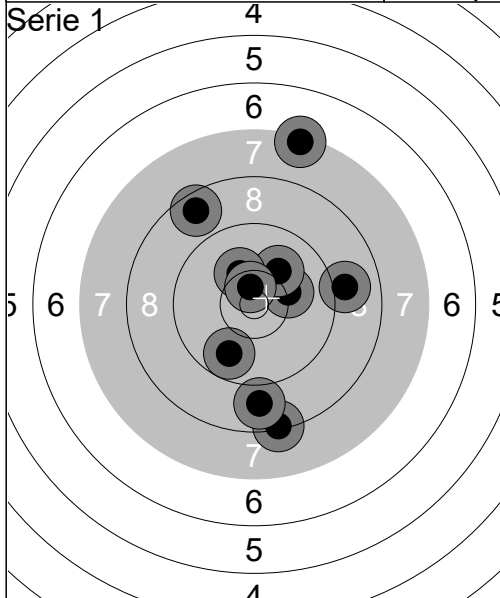

1:	7.4	↑
2:	8.3	↓
3:	8.6	↗
4:	10.2	→
5:	9.0	→
6:	9.8	↙
7:	10.1	↗
8:	8.8	↓
9:	10.2	↗
10:	10.6x	↑
Serie		89 (1x)
Total		89 (1x)

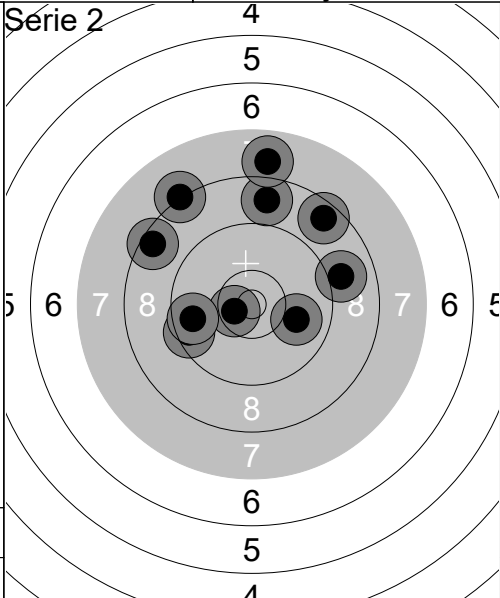

1:	10.5x	←
2:	8.7	↑
3:	9.5	←
4:	9.7	←
5:	9.9	→
6:	8.2	↗
7:	8.6	↗
8:	7.9	↑
9:	9.0	→
10:	8.5	↖
Serie		85 (1x)
Total		174 (2x)

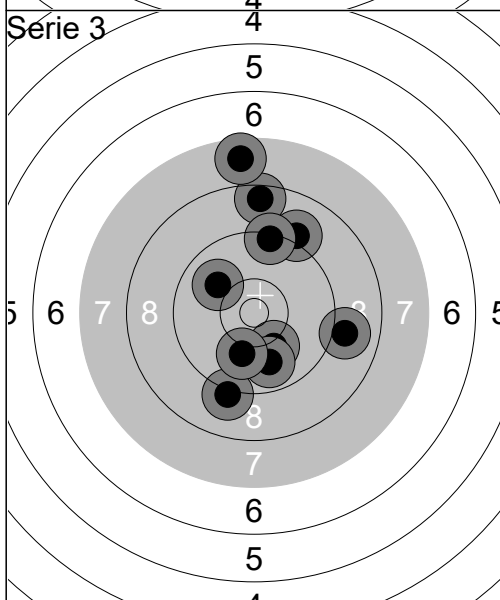

1:	8.5	↑
2:	10.1	↓
3:	9.1	↓
4:	10.0	↖
5:	7.7	↑
6:	9.9	↓
7:	9.1	↗
8:	9.0	→
9:	9.3	↑
10:	10.0	↓
Serie		90 (0x)
Total		264 (2x)

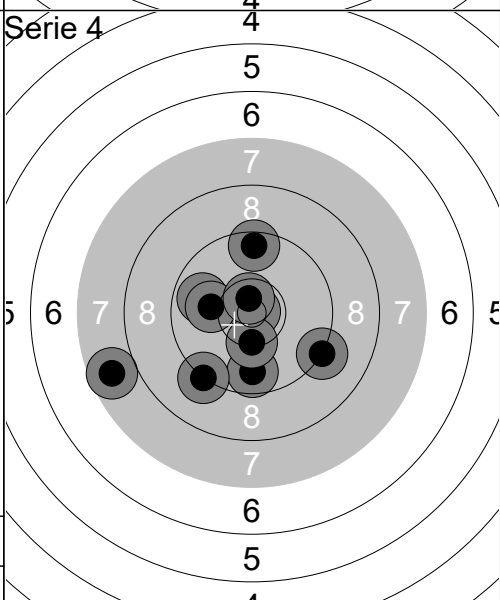

1:	9.9	←
2:	9.2	→
3:	9.7	↓
4:	9.5	↑
5:	10.9x	→
6:	7.7	←
7:	10.3	↓
8:	10.1	←
9:	9.2	↙
10:	10.6x	↑
Serie		92 (2x)
Total		356 (4x)

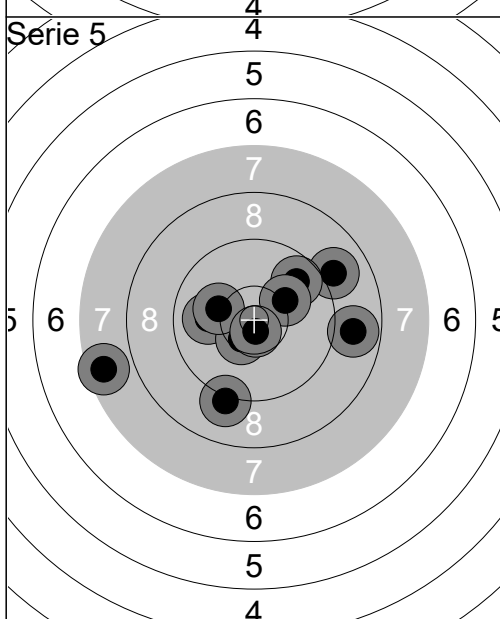

1:	10.0	←
2:	10.5x	↙
3:	7.6	←
4:	9.0	→
5:	9.7	↗
6:	9.1	↓
7:	10.1	←
8:	8.8	→
9:	10.2	↗
10:	10.7x	↓
Serie		92 (2x)
Total		448 (6x)

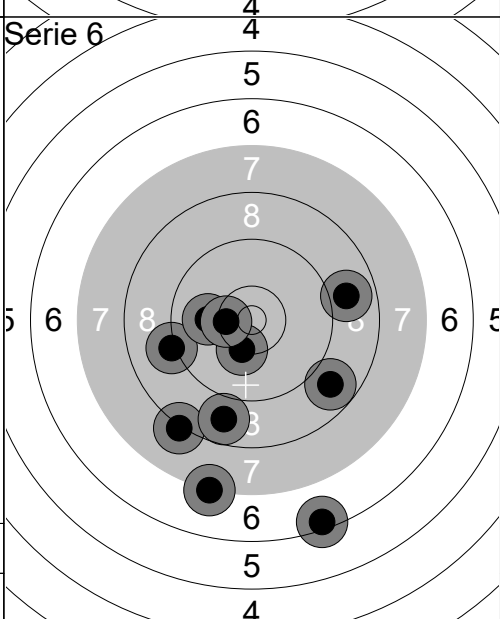

1:	6.4	↓
2:	10.3	↓
3:	8.2	↙
4:	9.1	←
5:	8.8	↘
6:	10.0	←
7:	10.4x	←
8:	7.2	↓
9:	8.8	↓
10:	8.9	→
Serie		84 (1x)
Total		532 (7x)

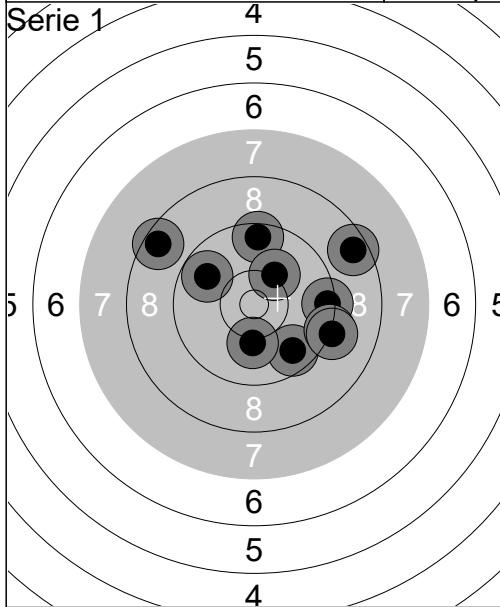

1:	8.5	↖
2:	9.8	↖
3:	9.5	↑
4:	9.4	→
5:	9.7	↘
6:	10.1	↓
7:	10.2	↗
8:	9.3	→
9:	8.5	↗
10:	9.2	↘
Serie		90 (0x)
Total		90 (0x)

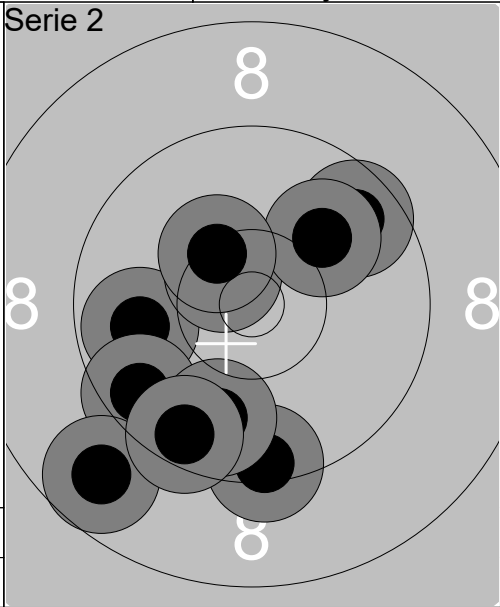

1:	9.9	←
2:	9.6	↙
3:	9.4	↓
4:	10.5x	↖
5:	9.7	↗
6:	9.8	↓
7:	8.8	↙
8:	10.0	↗
9:	10.4	↖
10:	9.5	↓
Serie		92 (1x)
Total		182 (1x)

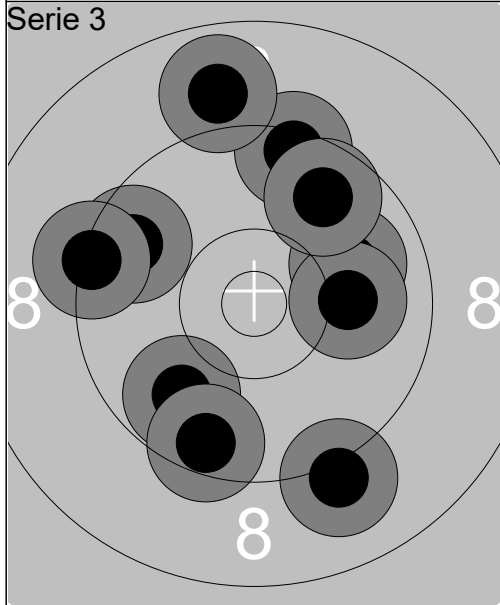

1:	10.0	↗
2:	9.1	↓
3:	9.6	↖
4:	9.3	←
5:	9.4	↑
6:	9.8	↙
7:	8.9	↑
8:	10.0	→
9:	9.5	↓
10:	9.7	↗
Serie		91 (0x)
Total		273 (1x)

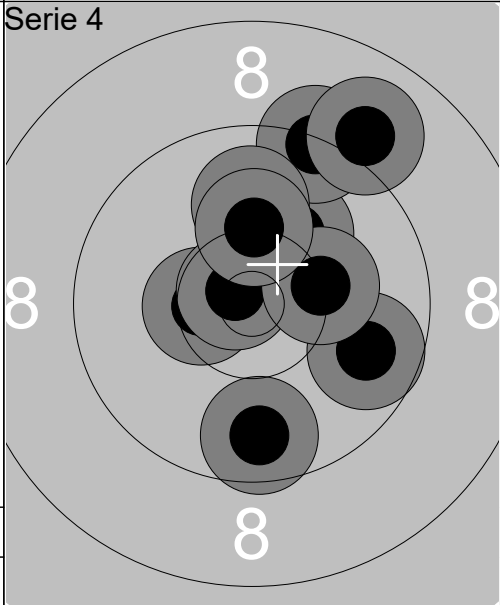

1:	10.2	↗
2:	10.5x	←
3:	9.3	↑
4:	10.7x	↖
5:	9.7	↓
6:	9.8	→
7:	10.3	→
8:	10.0	↑
9:	9.0	↗
10:	10.2	↑
Serie		96 (2x)
Total		369 (3x)

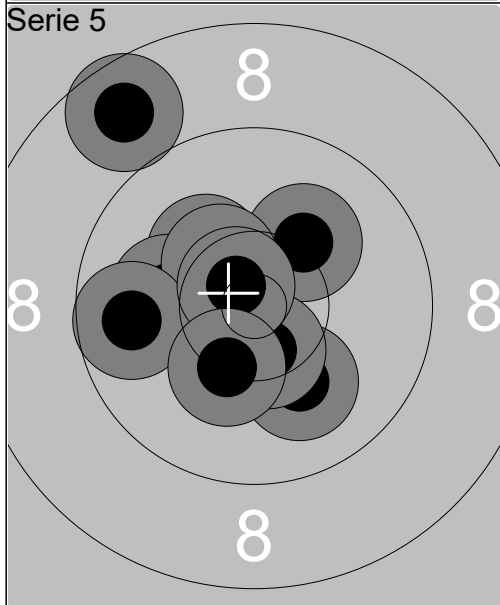

1:	8.7	↖
2:	10.1	↓
3:	10.3	↗
4:	10.1	←
5:	10.2	↗
6:	10.4x	↖
7:	9.8	←
8:	10.5x	↓
9:	10.7x	↖
10:	10.3	↓
Serie		97 (3x)
Total		466 (6x)

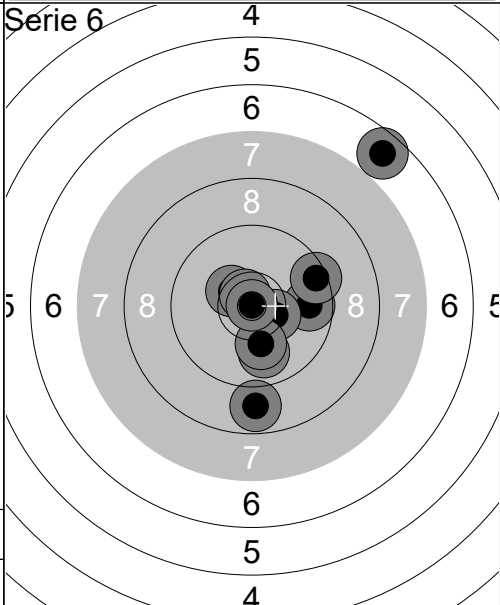

1:	9.9	↓
2:	9.7	→
3:	10.4x	↖
4:	8.8	↓
5:	10.4x	→
6:	10.7x	↖
7:	10.1	↓
8:	9.5	→
9:	6.7	↗
10:	10.9x	↑
Serie		91 (4x)
Total		557 (10x)

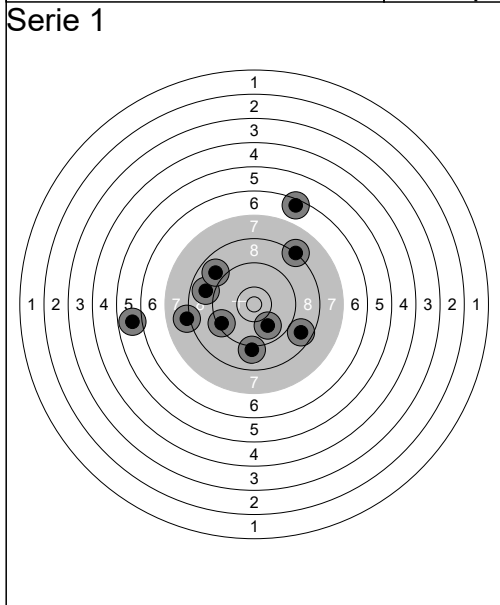

1:	8.2	↗
2:	6.5	↗
3:	8.9	↖
4:	9.9	↘
5:	8.9	↗
6:	9.1	↓
7:	9.4	↖
8:	5.8	↖
9:	8.7	↘
10:	8.1	↖
Serie		78 (0x)
Total		78 (0x)

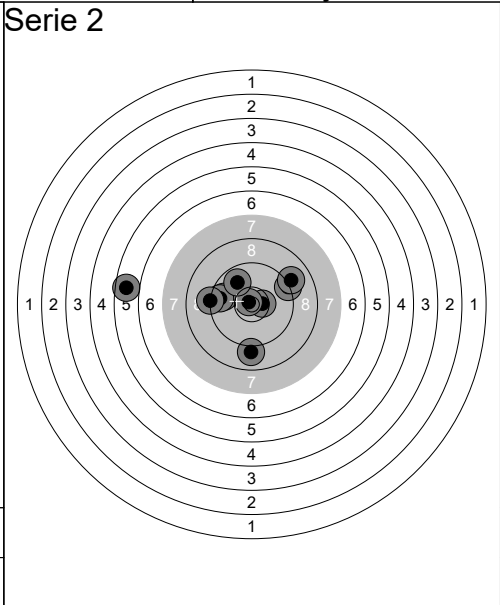

1:	9.7	↖
2:	9.6	↖
3:	9.2	↖
4:	10.5x	→
5:	5.7	↖
6:	9.0	↓
7:	9.3	↗
8:	10.8x	↖
9:	9.0	↗
10:	9.8	↗
Serie		88 (2x)
Total		166 (2x)

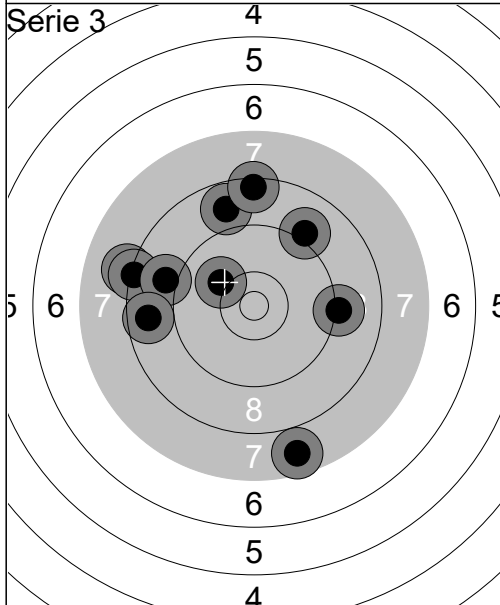

1:	8.8	↗
2:	8.1	↖
3:	8.4	↗
4:	10.1	↖
5:	8.3	↖
6:	7.7	↘
7:	9.1	→
8:	9.0	↖
9:	9.1	↗
10:	8.7	↖
Serie		84 (0x)
Total		250 (2x)

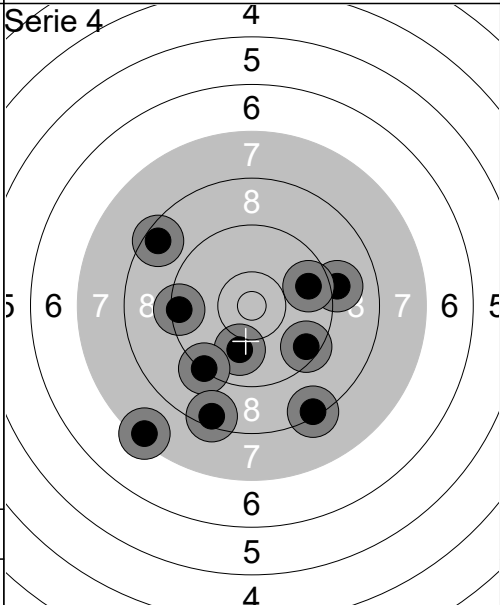

1:	10.0	↓
2:	9.3	↘
3:	8.5	↘
4:	7.4	↘
5:	9.1	→
6:	9.5	↘
7:	9.4	↖
8:	9.7	→
9:	8.3	↘
10:	8.5	↖
Serie		86 (0x)
Total		336 (2x)

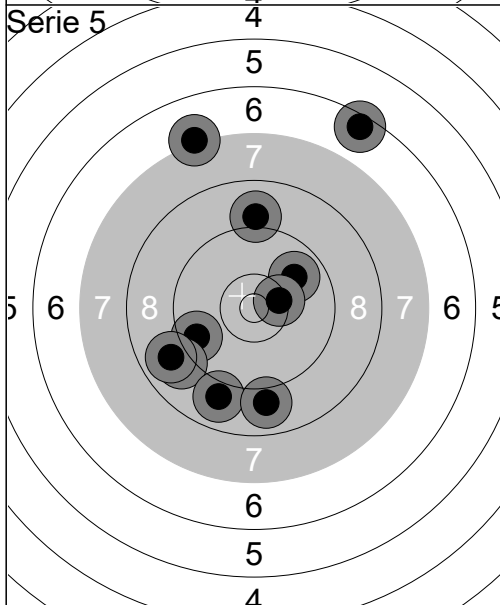

1:	9.6	↖
2:	9.0	↖
3:	7.2	↗
4:	8.9	↘
5:	9.0	↗
6:	9.9	↗
7:	6.5	↗
8:	8.9	↘
9:	8.9	↖
10:	10.4x	→
Serie		83 (1x)
Total		419 (3x)

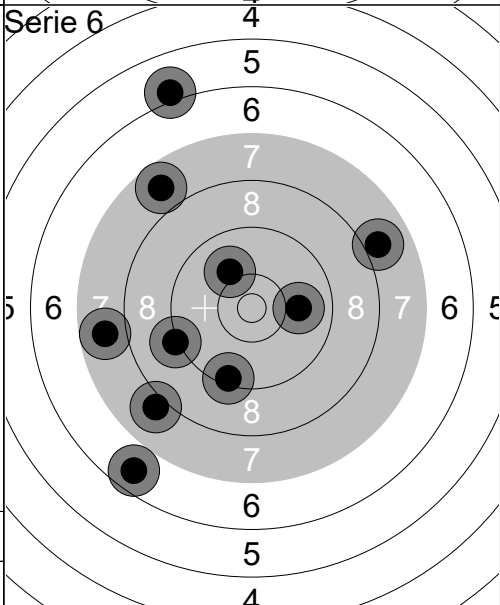

1:	7.7	↗
2:	6.0	↗
3:	8.0	↘
4:	7.9	↗
5:	9.2	↖
6:	9.9	→
7:	10.0	↗
8:	7.8	↖
9:	6.7	↘
10:	9.4	↘
Serie		78 (0x)
Total		497 (3x)

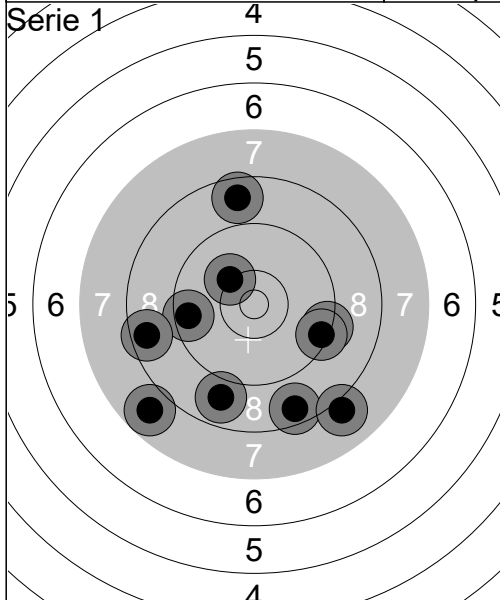

1:	8.5	↓
2:	9.3	→
3:	10.2	↗
4:	7.8	↙
5:	8.6	↑
6:	9.4	→
7:	8.0	↓
8:	9.5	←
9:	8.6	←
10:	8.8	↓
Serie		84 (0x)
Total		84 (0x)

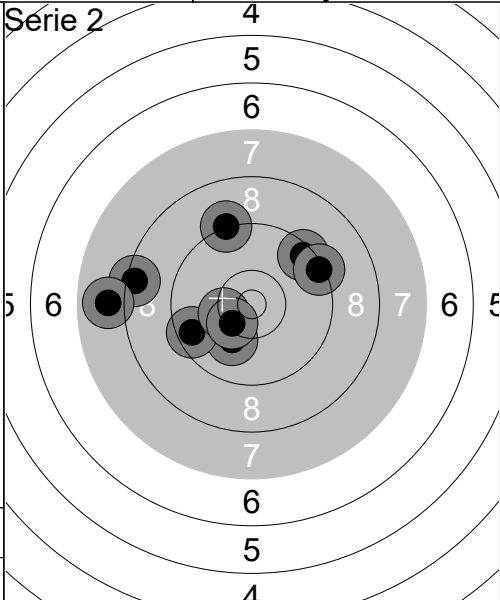

1:	8.4	←
2:	10.1	↓
3:	9.2	↗
4:	7.9	←
5:	9.4	↗
6:	10.2	←
7:	9.3	↗
8:	9.5	←
9:	10.3	←
10:	10.4x	↙
Serie		91 (1x)
Total		175 (1x)

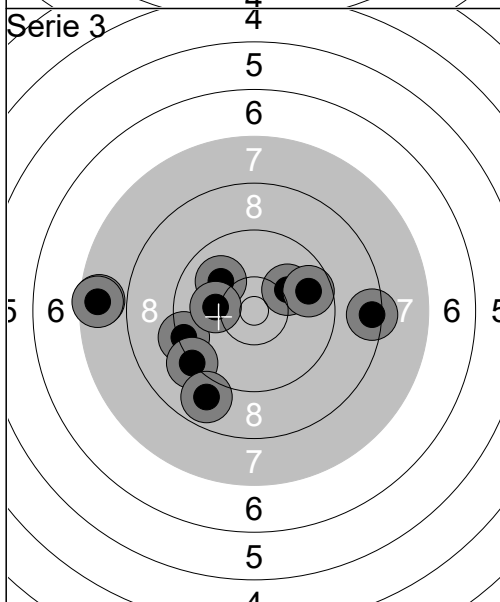

1:	9.3	←
2:	8.4	→
3:	10.1	↗
4:	9.2	↙
5:	7.6	←
6:	9.7	→
7:	8.8	↓
8:	7.6	←
9:	10.0	↗
10:	10.1	←
Serie		87 (0x)
Total		262 (1x)

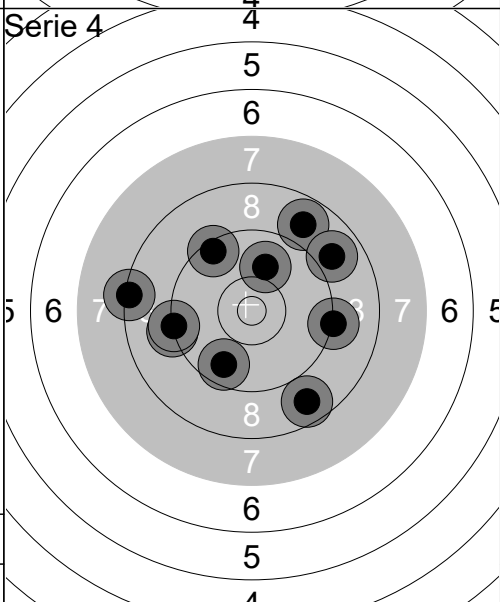

1:	9.4	↗
2:	9.2	→
3:	9.2	←
4:	8.8	↗
5:	8.7	↓
6:	9.7	↓
7:	9.2	←
8:	8.3	←
9:	10.0	↑
10:	8.9	↗
Serie		87 (0x)
Total		349 (1x)

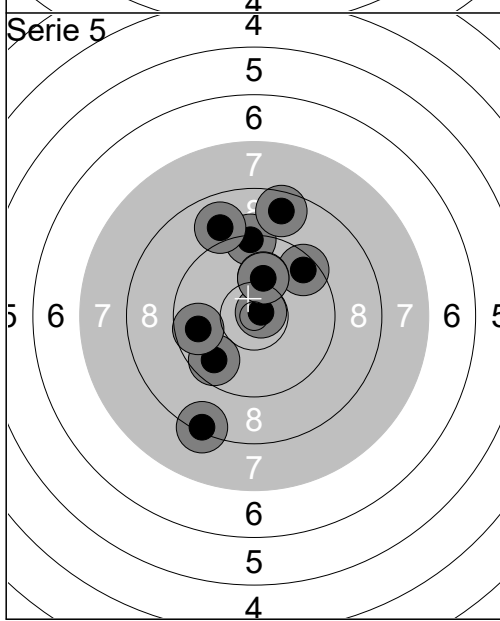

1:	10.8x	↗
2:	9.3	↑
3:	9.5	↗
4:	10.1	↑
5:	10.1	↑
6:	8.9	↑
7:	8.6	↑
8:	9.7	↙
9:	9.7	←
10:	8.3	↓
Serie		90 (1x)
Total		439 (2x)

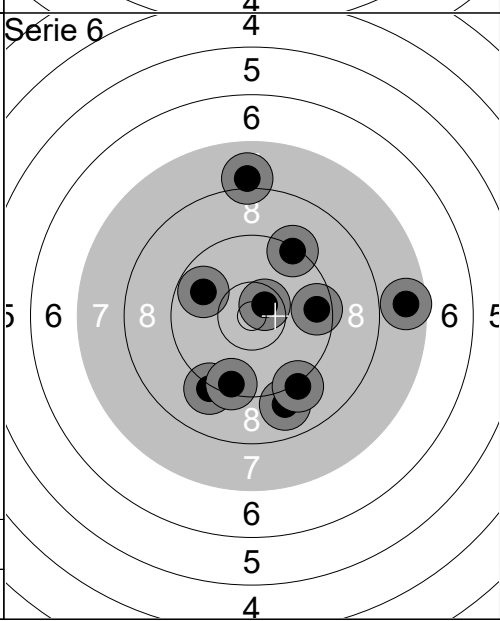

1:	7.6	→
2:	10.6x	↗
3:	9.2	↓
4:	9.8	←
5:	8.0	↑
6:	9.3	↗
7:	8.9	↓
8:	9.4	↓
9:	9.6	→
10:	9.2	↓
Serie		87 (1x)
Total		526 (3x)

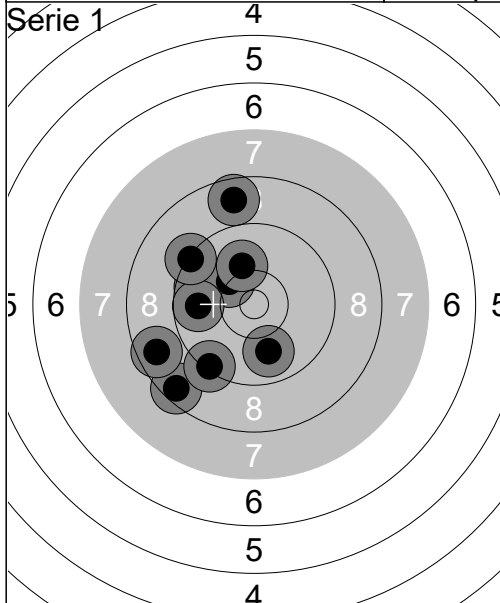

1:	9.7	↖
2:	10.2	↗
3:	10.1	↑
4:	8.7	↑
5:	8.5	↘
6:	9.8	←
7:	9.3	↗
8:	9.9	↓
9:	8.6	↖
10:	9.3	↘
Serie		89 (0x)
Total		89 (0x)

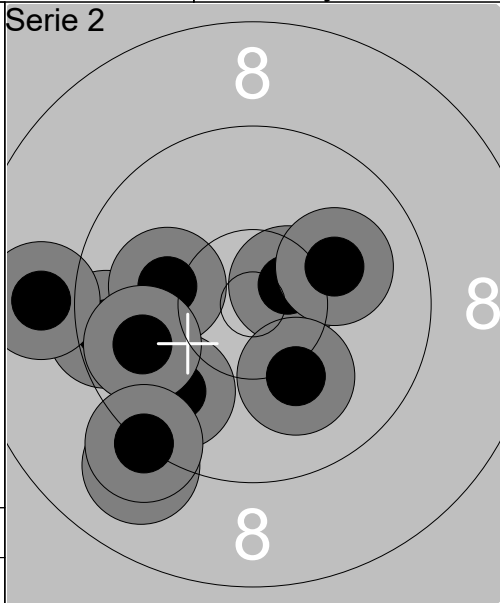

1:	10.6x	↗
2:	9.8	↘
3:	9.5	←
4:	10.1	↗
5:	8.9	←
6:	10.1	←
7:	9.1	↘
8:	10.1	↘
9:	9.8	←
10:	9.2	↘
Serie		93 (1x)
Total		182 (1x)

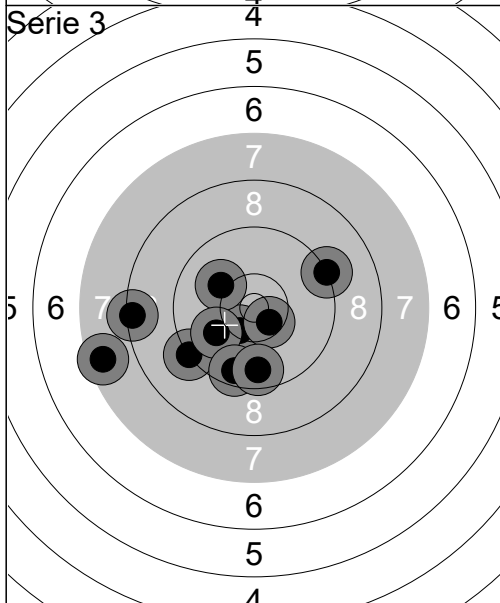

1:	10.4x	↘
2:	8.3	←
3:	7.5	←
4:	10.1	↖
5:	9.2	↗
6:	10.5x	↘
7:	9.2	←
8:	10.0	←
9:	9.5	↓
10:	9.6	↓
Serie		91 (2x)
Total		273 (3x)

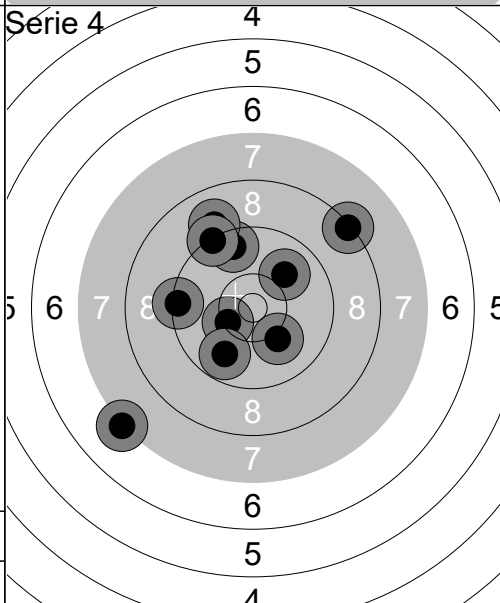

1:	8.3	↗
2:	7.2	↘
3:	10.3	↖
4:	10.1	↘
5:	9.8	↘
6:	9.6	↑
7:	9.0	↑
8:	10.0	↗
9:	9.3	←
10:	9.3	↖
Serie		90 (0x)
Total		363 (3x)

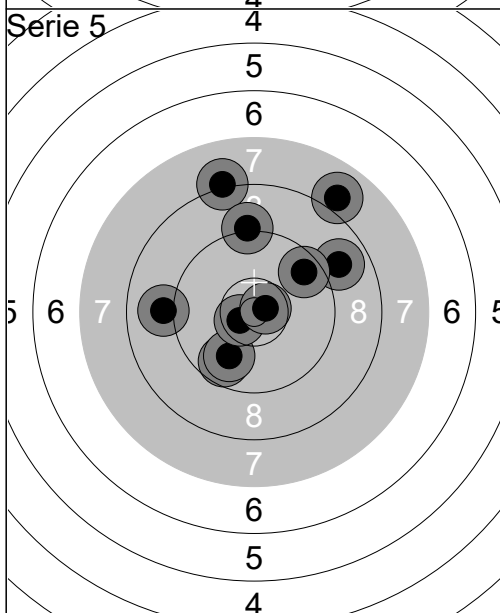

1:	9.7	↘
2:	8.2	↑
3:	9.0	←
4:	7.9	↗
5:	8.9	↗
6:	9.6	↗
7:	9.9	↘
8:	9.1	↑
9:	10.6x	↖
10:	10.7x	↗
Serie		88 (2x)
Total		451 (5x)

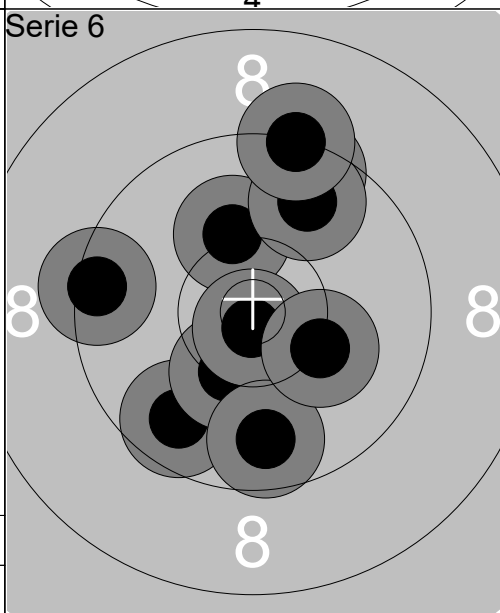

1:	9.4	←
2:	9.5	↑
3:	10.2	↑
4:	9.7	↘
5:	10.3	↘
6:	10.8x	↘
7:	9.8	↗
8:	9.2	↑
9:	9.7	↓
10:	10.2	↘
Serie		94 (1x)
Total		545 (6x)

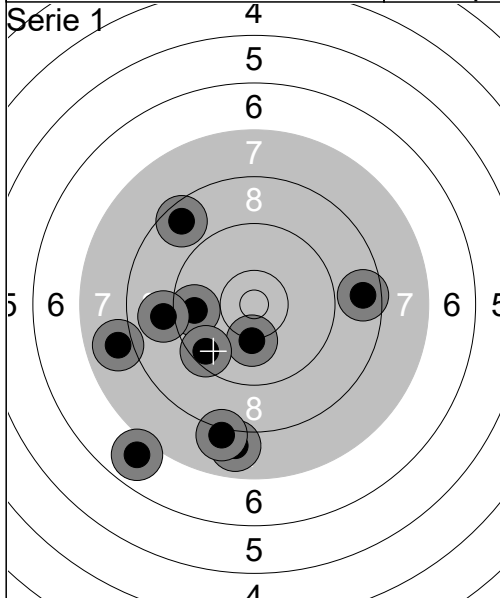

1:	8.6	→
2:	9.7	←
3:	7.9	←
4:	6.9	↙
5:	7.9	↓
6:	8.1	↓
7:	10.2	↓
8:	9.5	↙
9:	9.0	←
10:	8.6	↖
Serie	81 (0x)	
Total	81 (0x)	

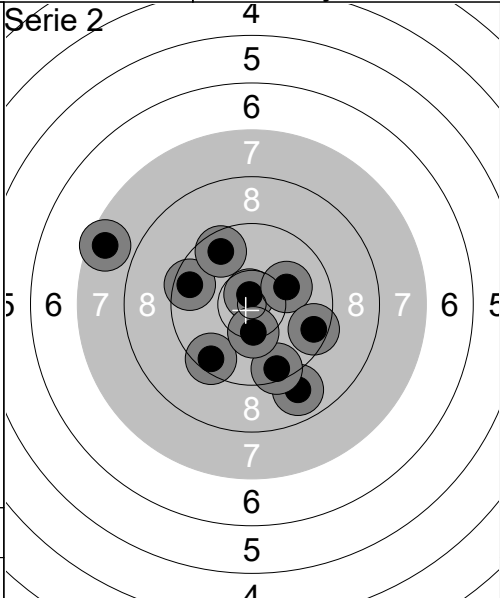

1:	9.6	←
2:	9.5	↙
3:	7.6	←
4:	10.7x	↑
5:	10.1	↗
6:	9.6	↑
7:	8.9	↓
8:	9.5	↓
9:	9.5	⇒
10:	10.3	↓
Serie	90 (1x)	
Total	171 (1x)	

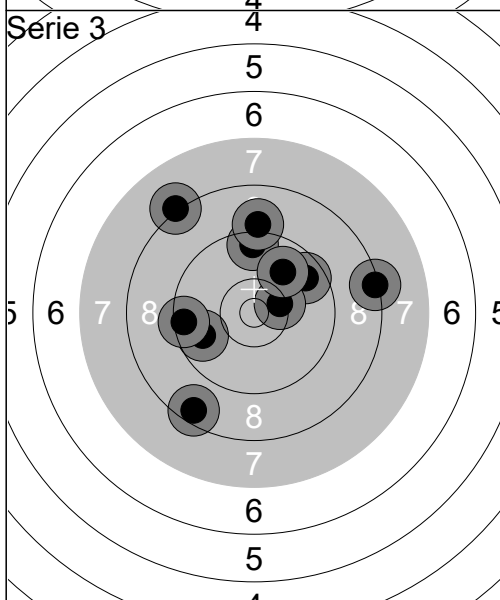

1:	8.3	→
2:	8.5	↙
3:	9.6	↗
4:	9.7	←
5:	9.5	↑
6:	9.1	↑
7:	10.4x	→
8:	9.4	←
9:	8.2	↖
10:	9.9	↗
Serie	88 (1x)	
Total	259 (2x)	

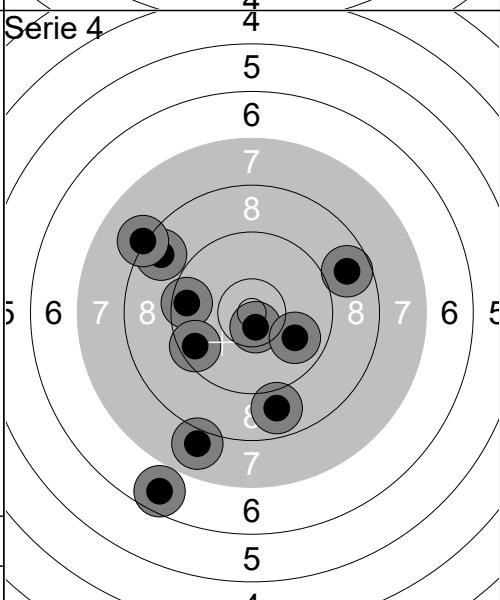

1:	10.6x	↓
2:	7.9	↓
3:	9.6	←
4:	8.8	↓
5:	6.7	↓
6:	9.5	←
7:	9.9	⇒
8:	8.7	↗
9:	8.7	↖
10:	8.2	↖
Serie	82 (1x)	
Total	341 (3x)	

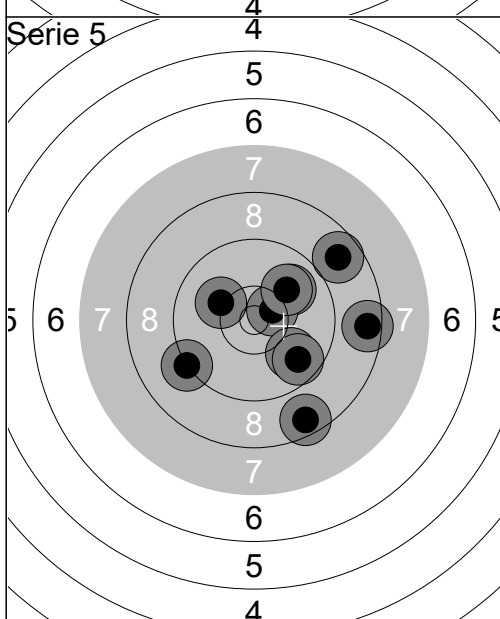

1:	9.2	←
2:	9.9	↗
3:	8.7	↗
4:	8.6	↓
5:	10.5x	↗
6:	8.5	→
7:	9.9	↘
8:	10.0	↗
9:	9.7	↘
10:	10.1	↖
Serie	90 (1x)	
Total	431 (4x)	

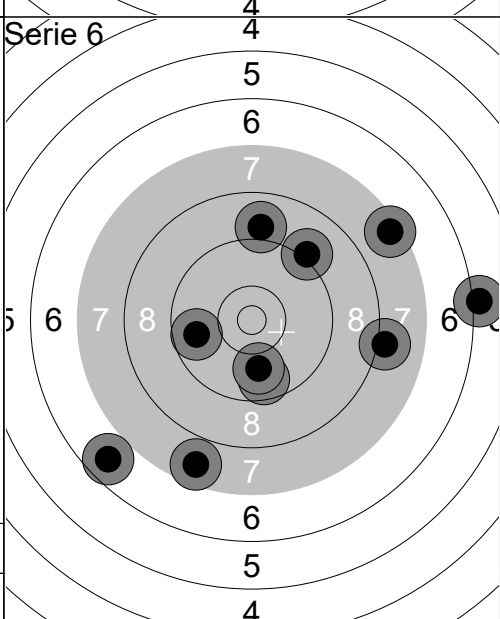

1:	9.7	↓
2:	9.1	↗
3:	8.1	→
4:	7.4	↗
5:	9.0	↑
6:	6.1	→
7:	9.9	↓
8:	9.7	←
9:	6.7	↙
10:	7.6	↓
Serie	79 (0x)	
Total	510 (4x)	

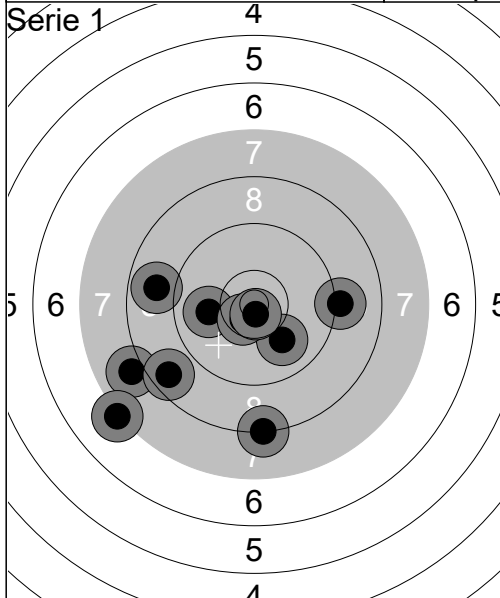

1:	10.0	←
2:	10.0	↘
3:	8.8	←
4:	10.5x	↘
5:	10.7x	↘
6:	9.1	→
7:	8.0	←
8:	7.2	↙
9:	8.2	↘
10:	8.6	↙
Serie		88 (2x)
Total		88 (2x)

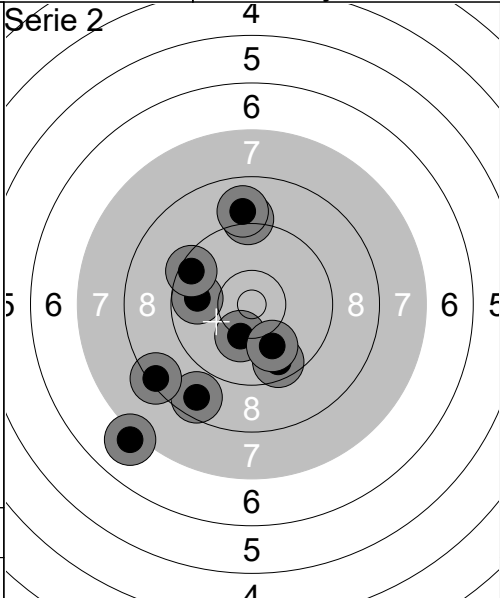

1:	9.1	↑
2:	8.6	↘
3:	9.0	↑
4:	9.8	←
5:	10.2	↘
6:	9.5	↖
7:	7.1	↘
8:	9.6	↘
9:	9.9	↘
10:	8.4	↙
Serie		87 (0x)
Total		175 (2x)

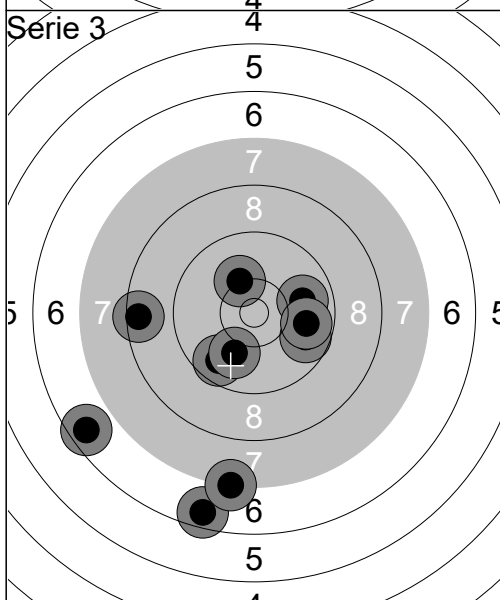

1:	9.9	→
2:	6.6	↘
3:	9.7	↘
4:	6.6	↙
5:	7.2	↘
6:	9.7	→
7:	10.0	↘
8:	8.5	←
9:	10.2	↗
10:	9.8	→
Serie		83 (0x)
Total		258 (2x)

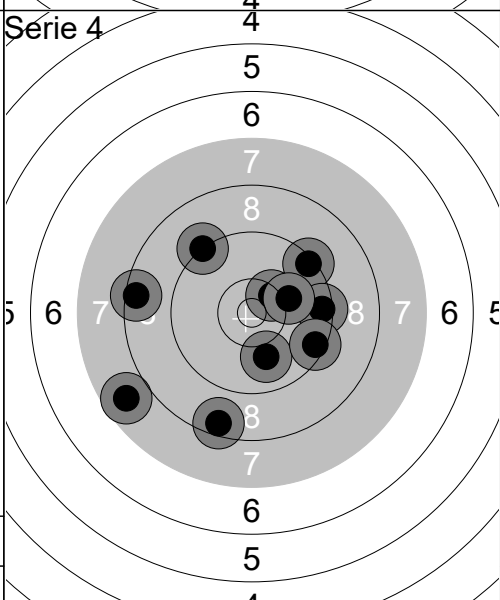

1:	9.3	↗
2:	8.5	←
3:	9.2	↗
4:	8.5	↘
5:	9.5	→
6:	10.0	↘
7:	10.4x	↗
8:	9.4	→
9:	7.7	↙
10:	10.1	→
Serie		89 (1x)
Total		347 (3x)

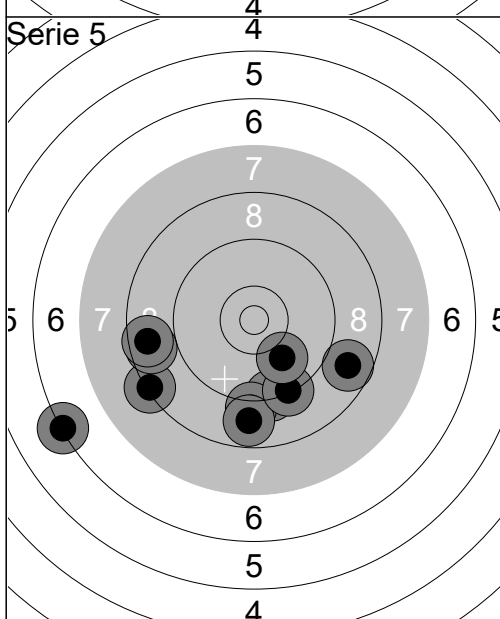

1:	9.3	↘
2:	9.1	↘
3:	6.3	↙
4:	8.8	↘
5:	8.3	↙
6:	8.7	←
7:	9.3	↘
8:	9.9	↘
9:	8.7	→
10:	8.6	←
Serie		82 (0x)
Total		429 (3x)

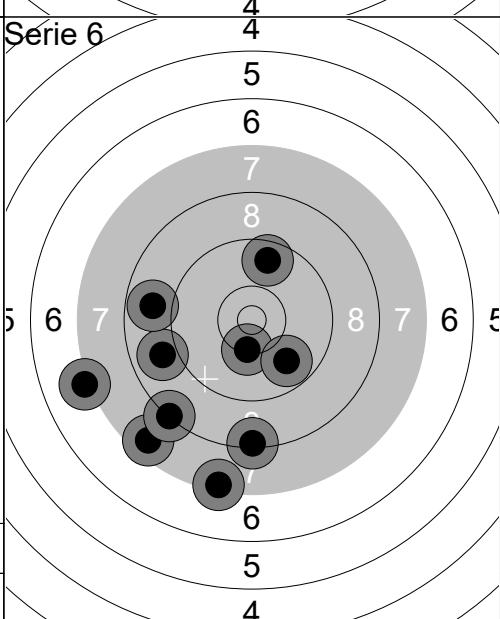

1:	7.1	←
2:	8.9	←
3:	8.8	←
4:	7.6	↙
5:	7.4	↘
6:	8.3	↘
7:	8.2	↙
8:	10.3	↘
9:	9.6	↗
10:	9.8	↘
Serie		81 (0x)
Total		510 (3x)

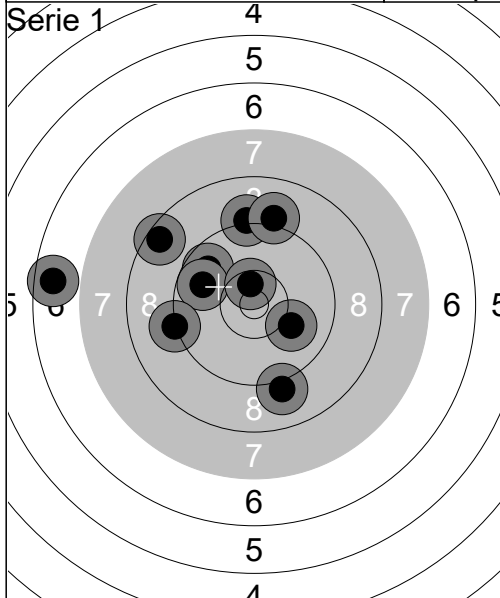

1:	9.7	↗
2:	8.5	↗
3:	10.0	➡
4:	6.6	←
5:	9.8	←
6:	10.5x	↑
7:	9.1	↑
8:	9.2	←
9:	9.1	↑
10:	9.1	↓
Serie		88 (1x)
Total		88 (1x)

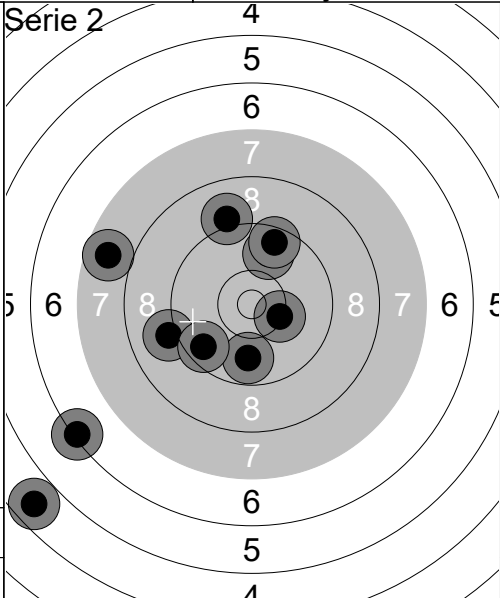

1:	9.8	↗
2:	4.7	↙
3:	9.1	↗
4:	6.3	↙
5:	9.1	←
6:	9.8	↓
7:	7.7	←
8:	9.6	↙
9:	10.3	➡
10:	9.5	↑
Serie		81 (0x)
Total		169 (1x)

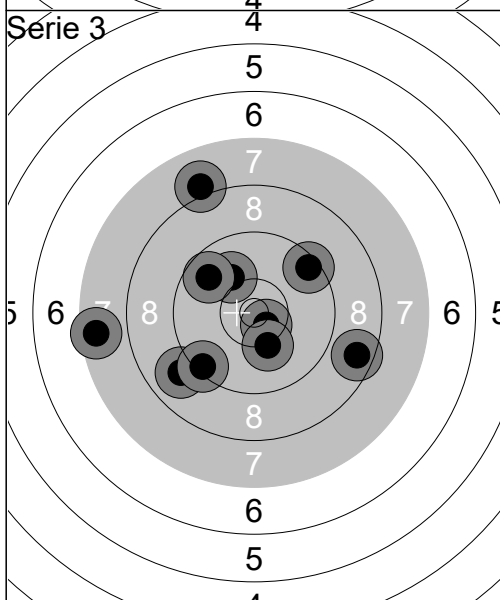

1:	10.1	↗
2:	8.6	➡
3:	7.6	←
4:	10.6x	↘
5:	10.2	↓
6:	8.9	←
7:	8.0	↑
8:	9.4	↗
9:	9.7	↗
10:	9.4	↙
Serie		88 (1x)
Total		257 (2x)

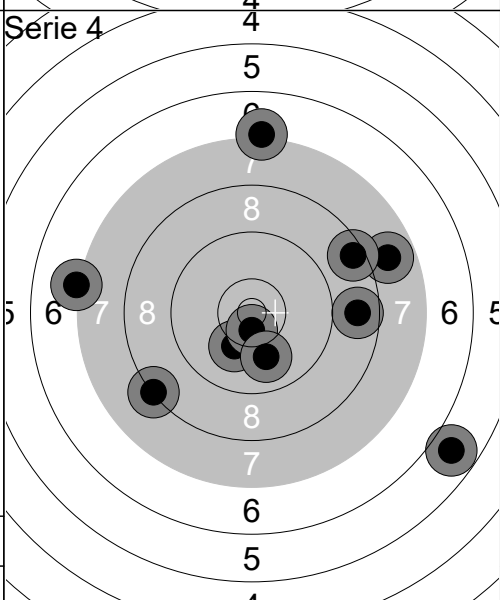

1:	7.8	➡
2:	7.1	↑
3:	7.2	←
4:	5.8	➡
5:	8.5	↗
6:	8.3	←
7:	10.2	↓
8:	10.6x	↓
9:	10.0	↓
10:	8.7	➡
Serie		80 (1x)
Total		337 (3x)

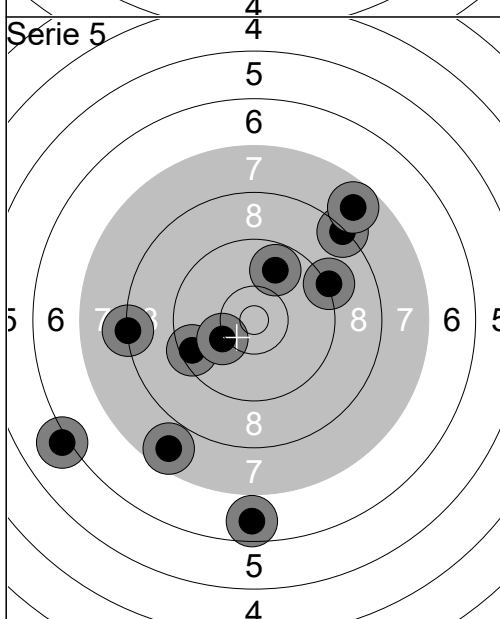

1:	7.7	↙
2:	9.5	←
3:	10.2	←
4:	6.1	←
5:	8.3	↗
6:	7.8	↗
7:	8.2	←
8:	6.7	↓
9:	9.8	↑
10:	9.2	➡
Serie		79 (0x)
Total		416 (3x)

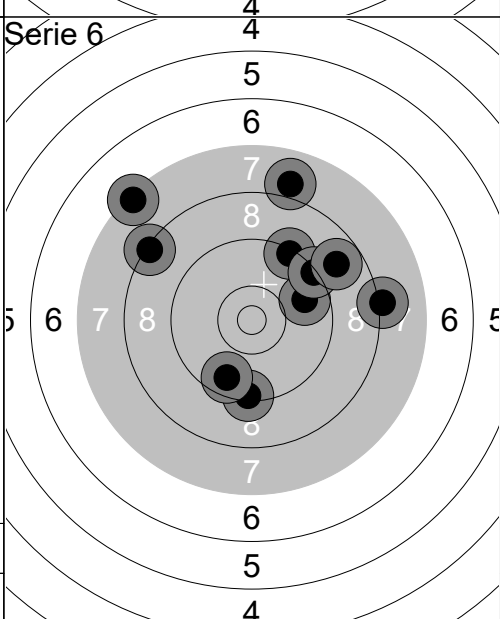

1:	8.3	↖
2:	9.3	↓
3:	9.7	➡
4:	8.1	➡
5:	7.3	↖
6:	9.3	↑
7:	9.3	↗
8:	7.9	↑
9:	8.8	↗
10:	9.6	↓
Serie		83 (0x)
Total		499 (3x)

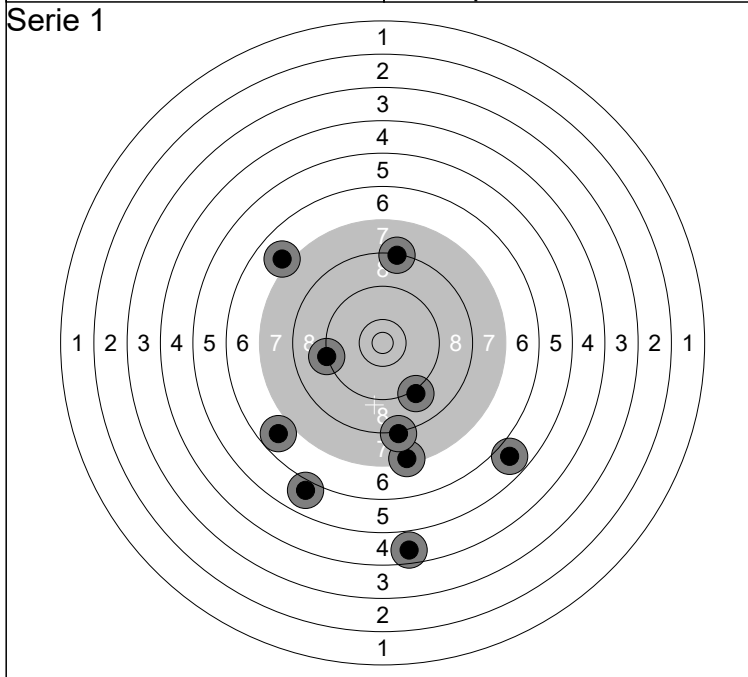

1: 5.8 ↘	6: 9.2 ←	Serie	68 (0x)
2: 6.8 ↙	7: 8.1 ↓		
3: 9.1 ↘	8: 5.9 ↙	Total	68 (0x)
4: 7.4 ↘	9: 8.3 ↑		
5: 7.0 ↗	10: 4.6 ↓		

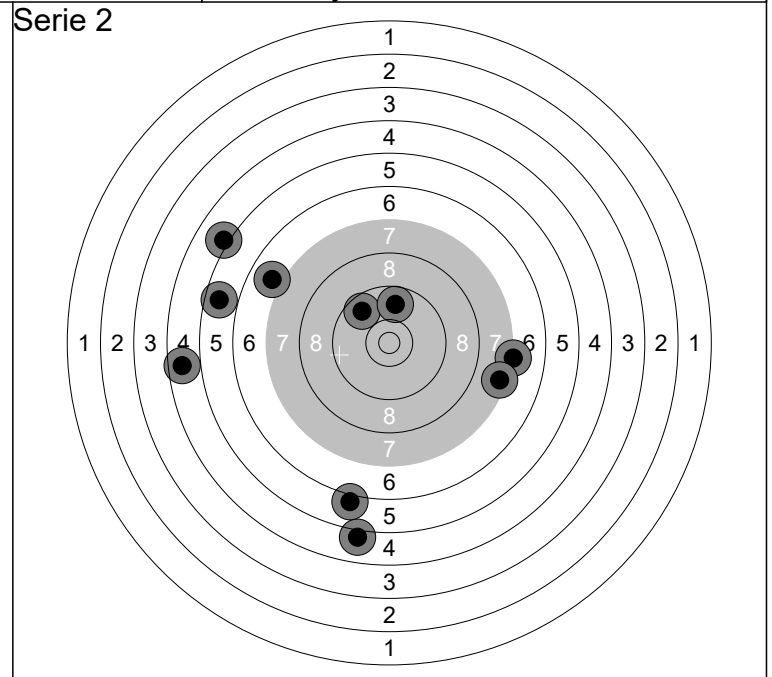

1: 7.2 →	6: 9.8 ↑	Serie	63 (0x)
2: 9.7 ↗	7: 5.0 ↓		
3: 7.4 →	8: 6.0 ↓	Total	131 (0x)
4: 5.1 ↗	9: 6.9 ↙		
5: 5.7 ←	10: 4.7 ←		

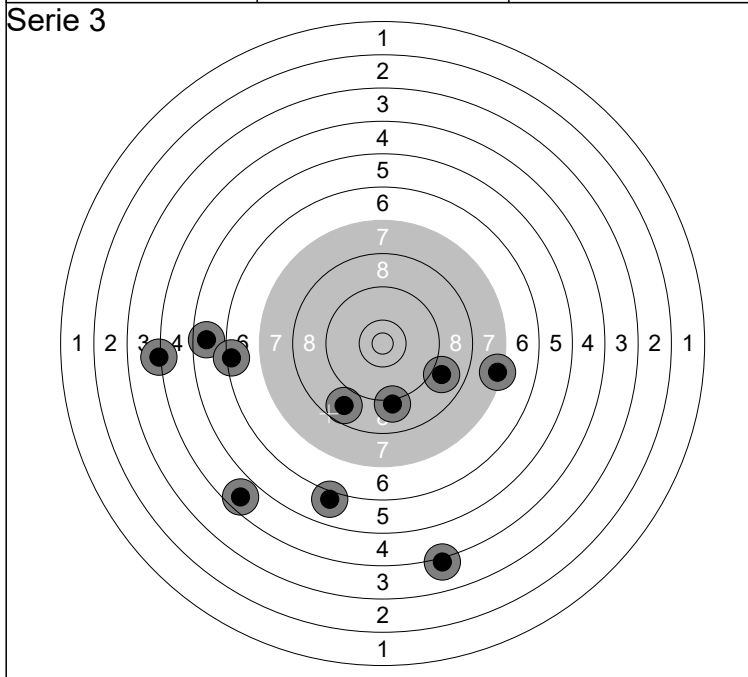

1: 7.4 →	6: 8.9 →	Serie	61 (0x)
2: 4.2 ←	7: 9.1 ↓		
3: 5.6 ←	8: 6.4 ←	Total	192 (0x)
4: 6.0 ↓	9: 8.7 ↙		
5: 4.1 ↓	10: 4.6 ↙		

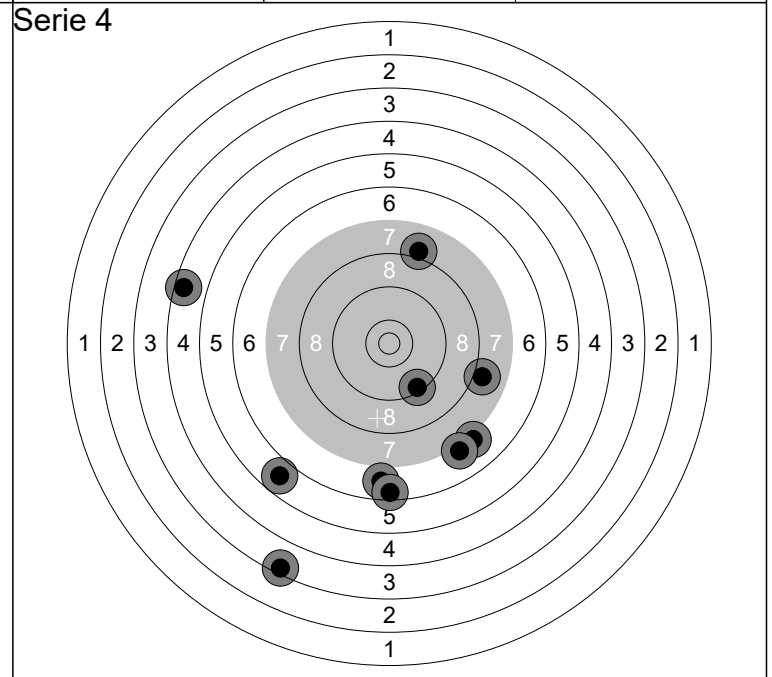

1: 4.5 ←	6: 7.1 ↘	Serie	63 (0x)
2: 9.4 ↓	7: 3.4 ↓		
3: 6.8 ↓	8: 6.5 ↓	Total	255 (0x)
4: 8.0 →	9: 5.8 ↙		
5: 8.0 ↑	10: 7.1 ↓		