

9.27s	9.3	↖
44.4s	9.9	↘
1:21m	9.8	↖
1:53m	10.2	↗
2:31m	10.2	→
12.3s	10.4	↗
43.5s	10.6x	↗
1:17m	9.2	↗
1:52m	10.3	↗
2:26m	8.6	↗
Serie	94 (1x)	
Total	94 (1x)	

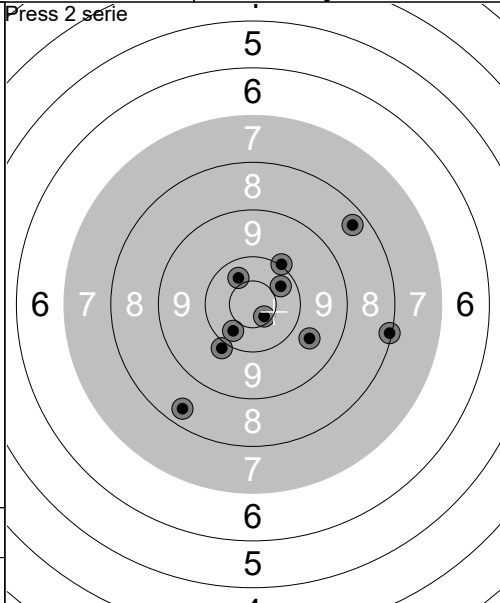

12.7s	8.4	↘
41.3s	9.7	↘
1:15m	8.1	→
1:45m	9.9	↘
2:17m	10.3	↘
11.8s	10.4	↖
40.9s	8.4	↗
1:13m	10.3	↗
1:46m	10.6x	↘
2:21m	10.0	↗
Serie	92 (1x)	
Total	186 (2x)	

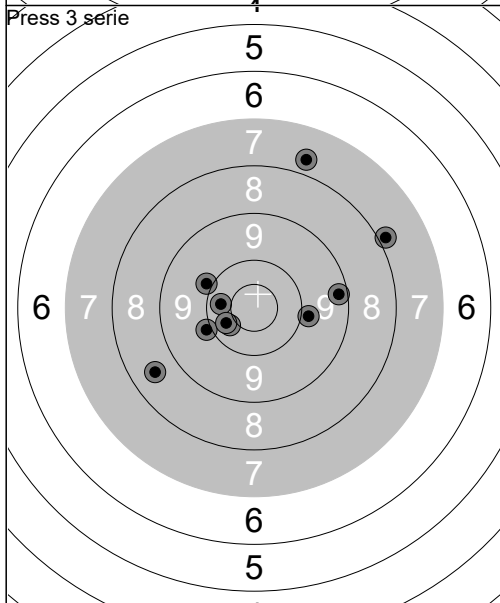

9.86s	10.4	↖
42.2s	7.9	↗
1:19m	10.0	↖
1:51m	8.6	↖
2:28m	9.9	↖
9.10s	7.7	↗
38.5s	9.2	→
1:06m	10.3	↖
1:34m	10.3	↖
2:05m	9.9	→
Serie	89 (0x)	
Total	275 (2x)	

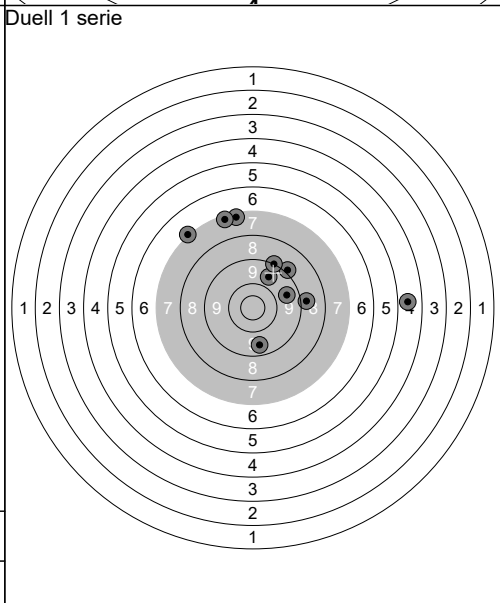

2.45s	10.3	↗
2.70s	8.7	↖
2.21s	9.9	→
2.25s	10.2	→
2.67s	8.9	↗
2.65s	8.9	↗
2.69s	10.2	↘
2.97s	7.3	→
2.31s	9.9	↗
2.29s	10.0	↗
Serie	89 (0x)	
Total	364 (2x)	

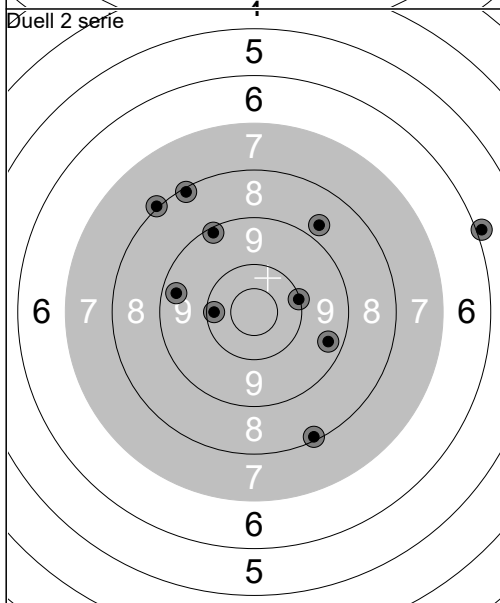

2.47s	10.1	→
2.38s	10.5x	→
2.46s	9.4	↘
2.38s	10.6x	↖
12.3s	10.2	↖
2.27s	9.8	↗
2.21s	9.4	↖
2.35s	8.1	→
2.61s	9.4	↖
2.60s	10.1	↖
Serie	94 (2x)	
Total	458 (4x)	

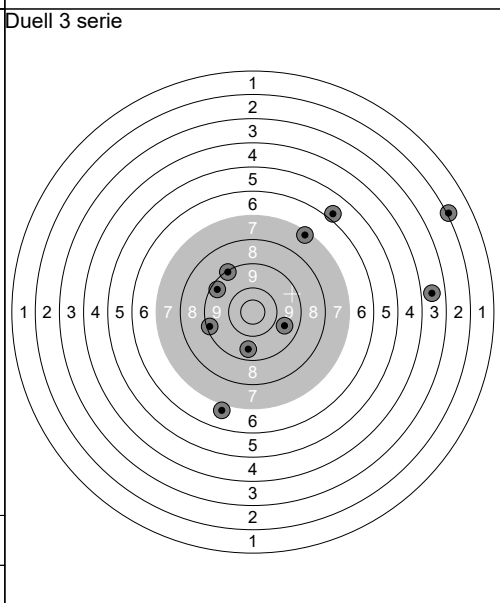

2.69s	8.9	↗
2.34s	10.1	↖
2.52s	10.1	↖
2.78s	5.6	↗
2.25s	10.0	↖
2.56s	8.6	↘
2.39s	8.0	↗
2.64s	6.6	→
2.36s	10.3	→
2.61s	10.2	↘
Serie	85 (0x)	
Total	543 (4x)	

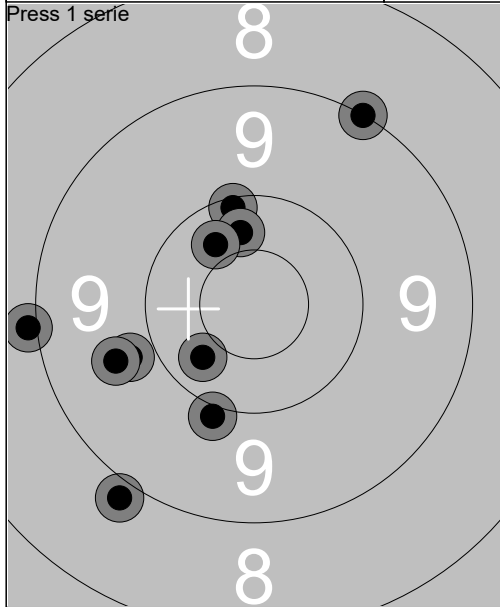

14.3s	9.1	↗
40.4s	10.1	↑
1:12m	10.3	↑
1:38m	10.0	↓
2:02m	9.8	←
15.6s	10.4	↗
37.0s	9.0	←
1:01m	10.3	↙
1:22m	8.9	↙
2:11m	9.7	←
Serie	94 (0x)	
Total	94 (0x)	

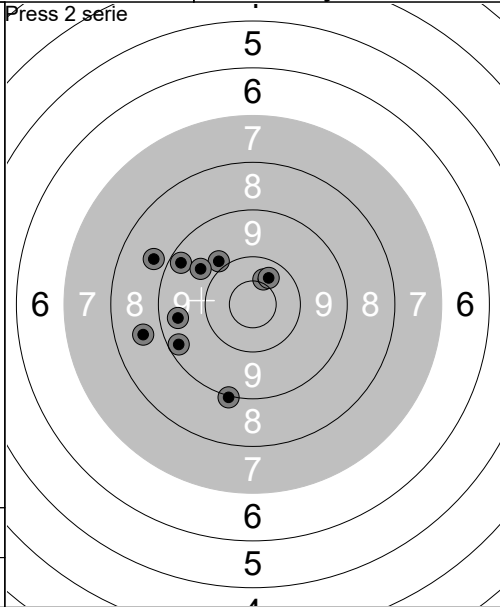

12.6s	8.8	↖
40.8s	8.7	←
1:10m	10.4x	↗
1:36m	9.3	↖
2:06m	9.9	↗
12.4s	9.7	↖
42.1s	10.4	↗
1:09m	9.0	↓
1:34m	9.5	←
2:04m	9.3	←
Serie	90 (1x)	
Total	184 (1x)	

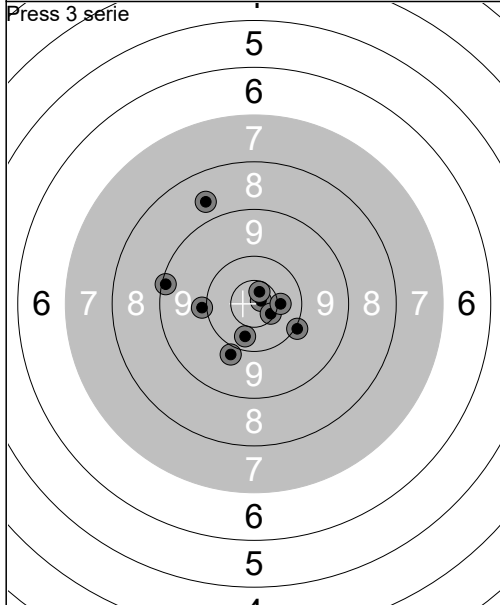

11.3s	10.8x	↗
42.7s	9.9	↙
1:05m	10.3	↓
1:30m	10.6x	↘
2:18m	10.0	↘
11.6s	10.4x	↗
36.0s	9.1	←
1:05m	10.7x	↗
1:26m	8.7	↗
2:12m	10.0	←
Serie	96 (4x)	
Total	280 (5x)	

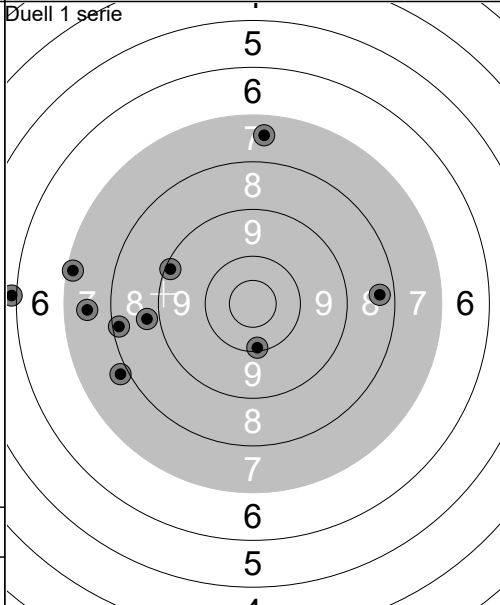

2.35s	9.0	↑
2.52s	10.1	↖
2.29s	10.5x	↓
2.50s	9.9	←
1.97s	9.1	←
2.18s	9.3	←
2.44s	9.6	→
2.54s	8.8	←
2.25s	8.1	←
2.49s	9.5	←
Serie	90 (1x)	
Total	370 (6x)	

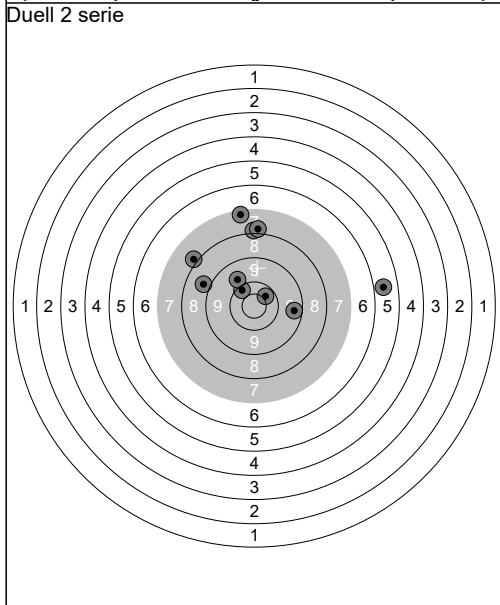

2.54s	10.6x	↖
2.27s	10.2	→
2.49s	7.9	→
12.5s	10.3	↖
22.6s	9.3	↑
2.31s	10.7x	↗
2.47s	9.3	↑
2.35s	9.3	↖
2.44s	9.8	↖
2.54s	8.9	↑
Serie	91 (2x)	
Total	461 (8x)	

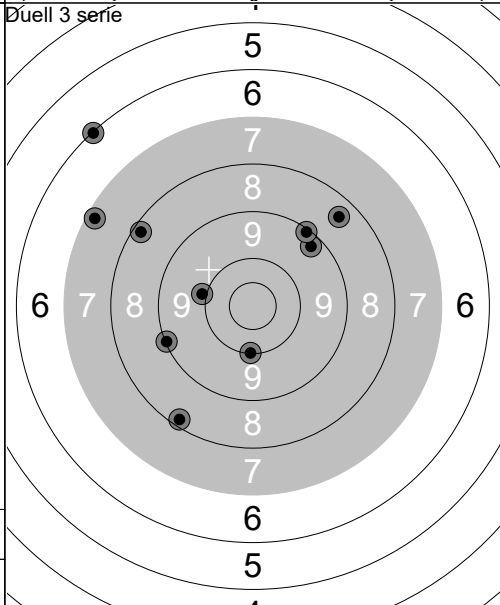

2.45s	9.5	↖
2.16s	9.6	↗
2.38s	10.1	↗
12.5s	9.5	↙
22.5s	10.0	↗
2.35s	10.0	←
2.74s	8.9	↖
2.49s	8.2	↗
2.72s	10.4x	↖
2.52s	10.5x	↓
Serie	93 (2x)	
Total	554 (10x)	

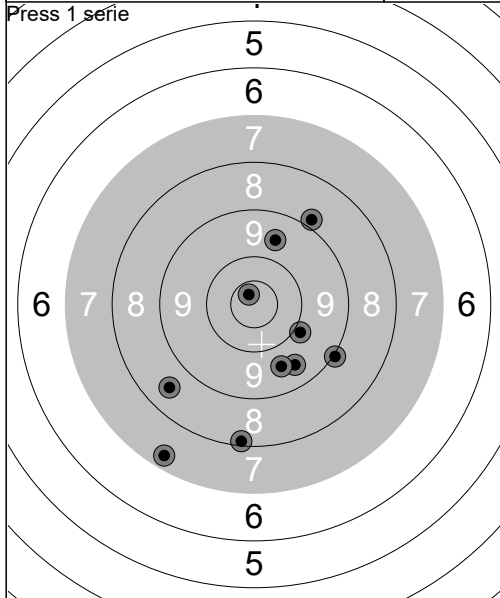

5	14.7s	9.2	↙
6	45.7s	10.1	↓
7	1:15m	10.8x	←
8	1:40m	9.4	↓
9	2:14m	8.0	↓
9	11.8s	10.1	↗
8	35.5s	9.1	↘
9	1:02m	10.2	↖
8	1:28m	9.6	↓
7	1:52m	9.1	←
6	Serie 93 (1x)		
5	Total 179 (2x)		

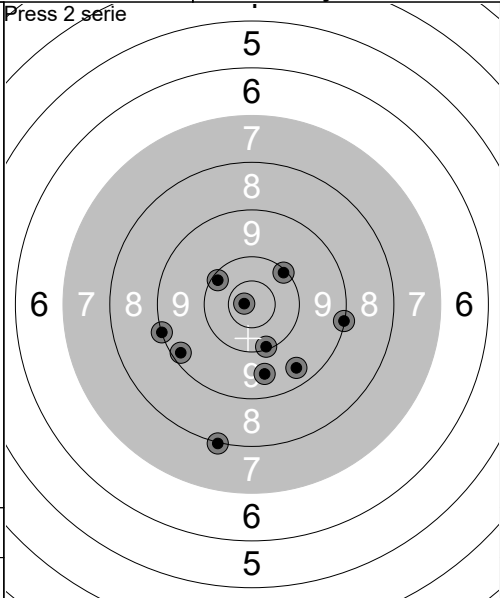

Duell 1 serie

5	2.42s	10.6x	↗
6	2.33s	10.6x	↓
7	2.42s	9.1	↗
8	2.27s	9.7	↙
9	2.62s	10.0	↗
9	2.89s	9.9	↓
8	2.45s	9.1	↙
9	2.59s	10.1	↙
8	2.50s	10.3	↘
7	2.86s	10.4	↗
6	Serie 96 (2x)		
5	Total 367 (6x)		

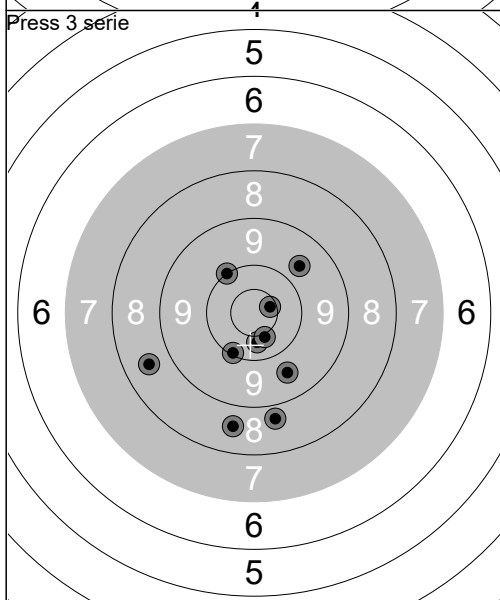

Duell 2 serie

5	2.77s	10.4x	↘
6	2.76s	10.0	↗
7	2.57s	10.0	↙
8	2.41s	9.6	↓
9	2.33s	7.2	↙
9	2.76s	10.3	↙
8	2.50s	8.9	↙
9	2.29s	10.1	↘
8	2.67s	10.5x	↘
7	2.65s	8.6	↘
6	Serie 92 (2x)		
5	Total 551 (10x)		

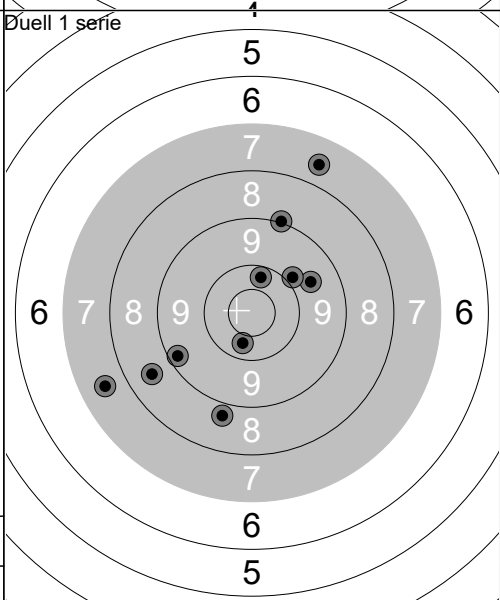

Duell 3 serie

1	2.77s	10.4x	↘
2	2.76s	10.0	↗
3	2.57s	10.0	↙
4	2.41s	9.6	↓
5	2.33s	7.2	↙
6	2.76s	10.3	↙
7	2.50s	8.9	↙
8	2.29s	10.1	↘
9	2.67s	10.5x	↘
8	2.65s	8.6	↘
7	Serie 92 (2x)		
6	Total 551 (10x)		

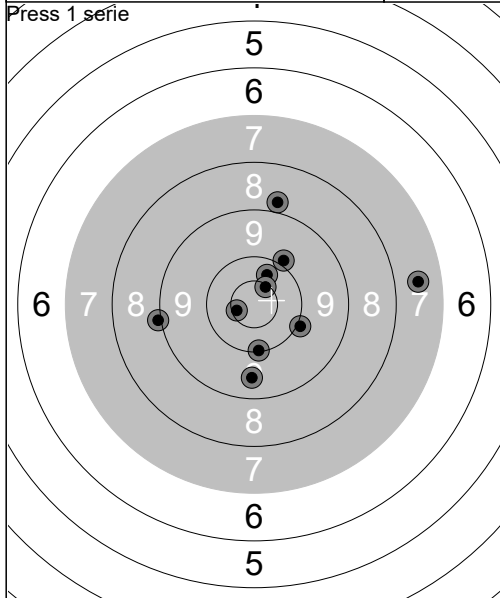

5	15.7s	10.4	←
6	54.4s	9.4	↑
7	1:25m	10.6x	↖
8	1:57m	8.8	↑
9	3:01m	8.8	↗
6	43.6s	9.5	↖
7	1:07m	9.8	←
8	1:34m	9.9	→
9	2:03m	10.8x	↓
6	2:33m	9.5	↖
5	Serie	91 (2x)	
4	Total	183 (4x)	

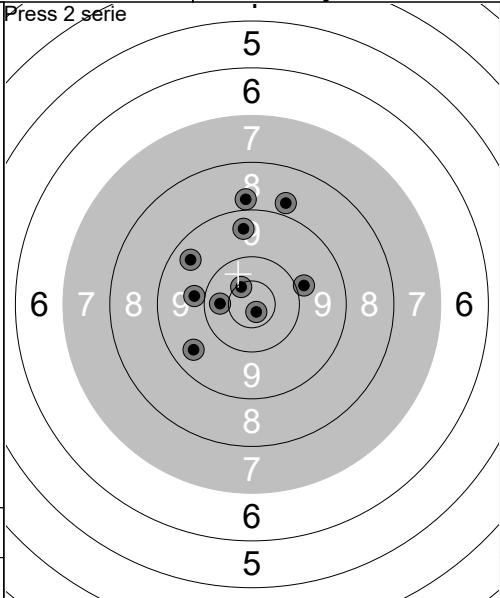

Duell 1 serie

5	2.66s	9.1	↓
6	2.74s	10.3	↓
7	2.80s	9.0	↓
8	2.91s	7.7	↖
9	2.79s	9.2	↓
6	2.49s	9.6	↘
7	2.34s	7.8	↘
8	2.80s	10.3	↗
9	2.77s	8.5	↘
6	2.84s	8.6	↓
5	Serie	86 (0x)	
4	Total	363 (6x)	

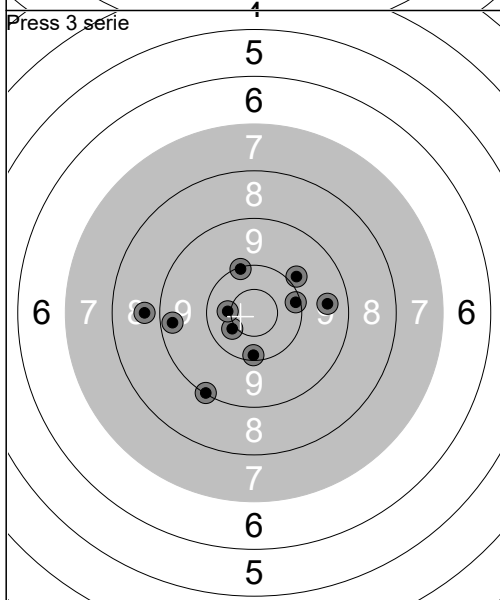

Duell 2 serie

5	2.63s	10.3	→
6	2.45s	9.2	→
7	2.58s	10.4x	↘
8	2.29s	10.3	↗
9	2.52s	10.2	↘
6	2.65s	10.5x	↗
7	2.52s	8.6	↘
8	2.77s	9.4	↓
9	2.63s	9.3	↓
6	2.80s	8.8	↖
5	Serie	93 (2x)	
4	Total	548 (10x)	

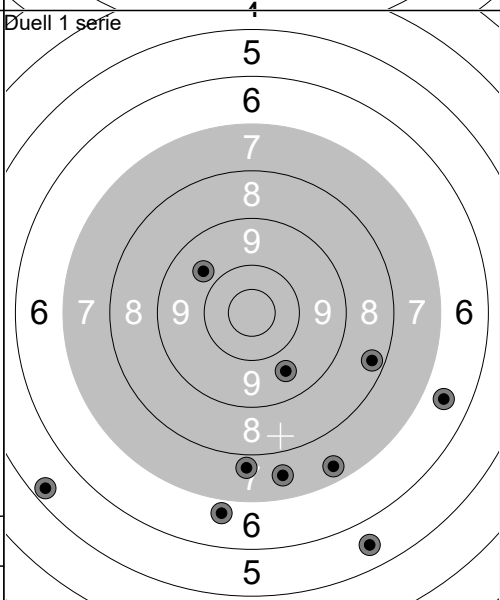

Duell 3 serie

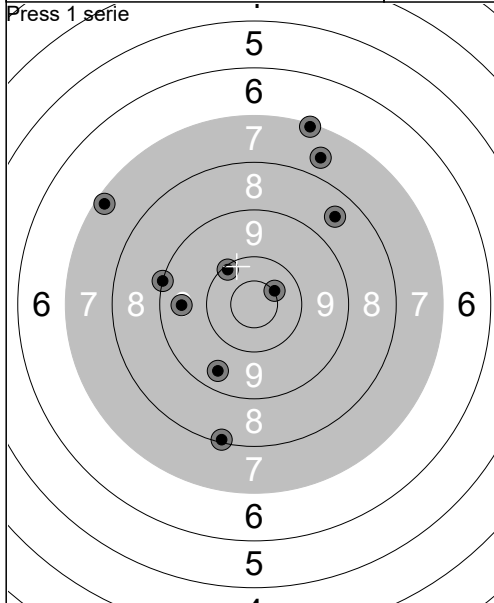

12.3s	9.1	←
39.9s	7.1	↑
1:04m	10.1	↖
1:42m	9.5	←
2:40m	7.2	↖
17.1s	8.1	↓
43.4s	7.6	↑
1:11m	8.5	↗
1:33m	10.5x	↗
2:31m	9.5	↓
Serie	84 (1x)	
Total	84 (1x)	

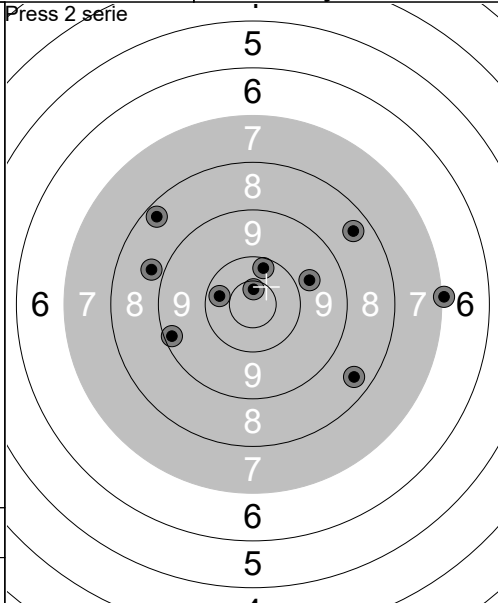

17.6s	10.2	↑
47.3s	8.4	↘
1:38m	7.0	→
1:55m	8.4	↗
2:18m	10.7x	↑
15.3s	9.8	↗
1:08m	8.3	↖
1:32m	10.3	←
2:05m	9.2	←
2:29m	8.8	←
Serie	87 (1x)	
Total	171 (2x)	

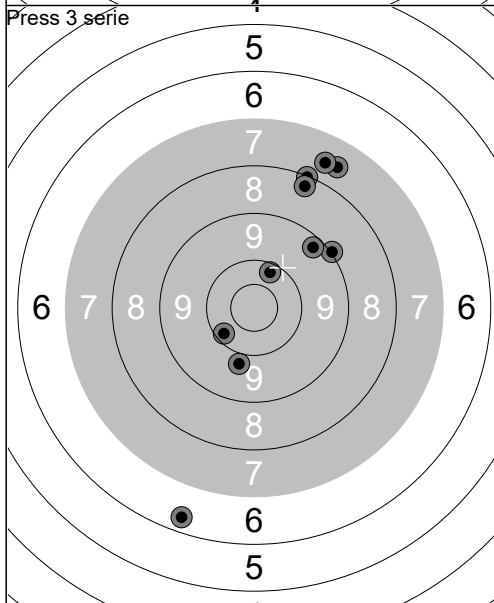

20.3s	10.2	↖
44.9s	9.8	↓
1:40m	10.2	↑
2:11m	7.6	↑
2:32m	8.1	↑
30.4s	9.0	↗
1:15m	9.3	↗
1:39m	6.4	↓
2:00m	8.3	↑
2:21m	7.6	↑
Serie	83 (0x)	
Total	254 (2x)	

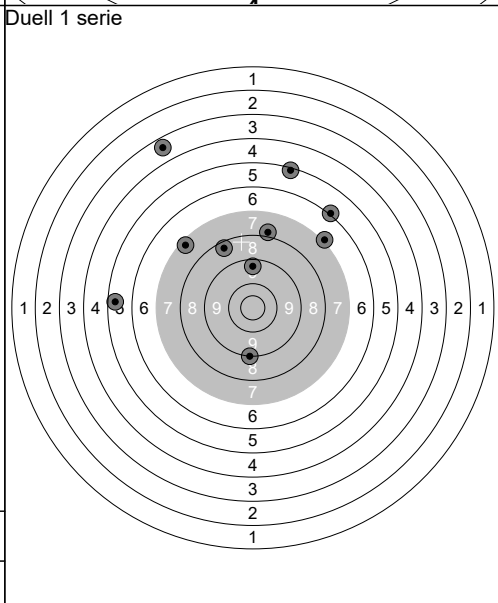

2.18s	8.7	↗
1.64s	9.6	↖
1.78s	10.1	↑
1.74s	9.3	↑
2.22s	8.1	↗
2.29s	7.7	←
2.17s	6.5	↖
1.94s	10.0	↓
1.87s	7.6	↑
2.11s	8.9	↖
Serie	82 (0x)	
Total	336 (2x)	

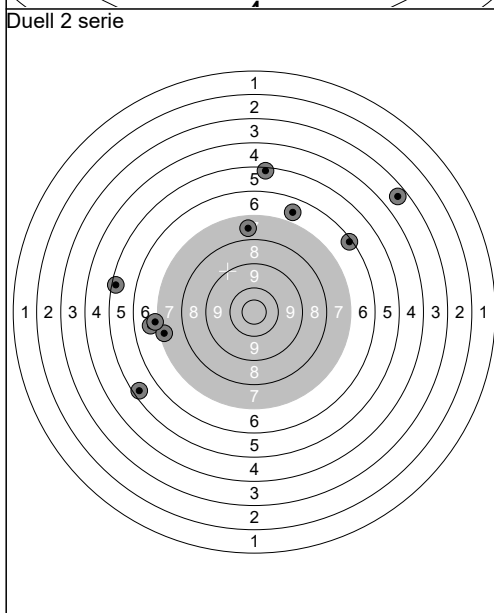

2.36s	6.5	↗
2.16s	8.2	↗
1.67s	8.6	←
1.88s	7.6	↑
1.76s	8.9	←
1.83s	7.6	←
2.06s	7.7	←
1.96s	9.1	↑
1.79s	8.5	↑
1.83s	8.7	←
Serie	76 (0x)	
Total	412 (2x)	

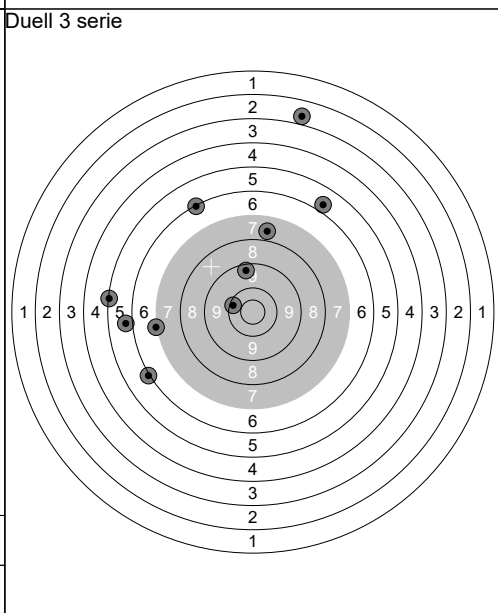

1.98s	7.9	↗
1.85s	10.5x	↖
1.81s	8.2	↖
1.97s	8.7	←
2.00s	8.0	←
1.88s	9.1	↑
1.90s	8.1	←
2.17s	7.5	←
1.84s	10.1	↑
1.98s	6.0	↑
Serie	81 (1x)	
Total	493 (3x)	

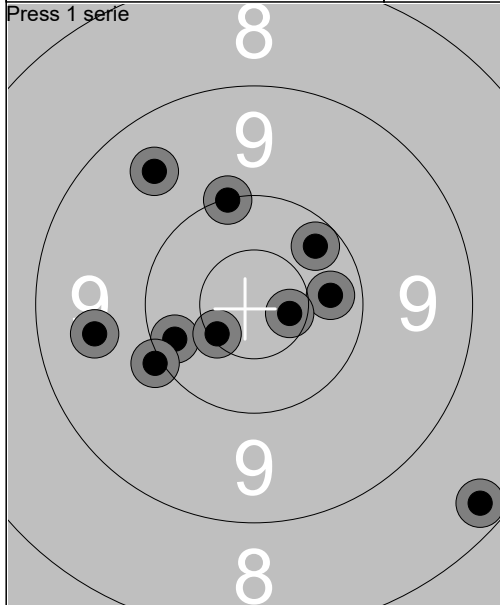

13.1s	10.2	←
45.9s	9.6	←
1:21m	8.3	↘
1:59m	10.3	→
2:31m	10.1	↑
9.82s	10.6x	↙
41.1s	10.0	←
1:12m	9.5	↖
2:11m	10.6x	→
2:39m	10.2	↗
Serie	96 (2x)	
Total	96 (2x)	

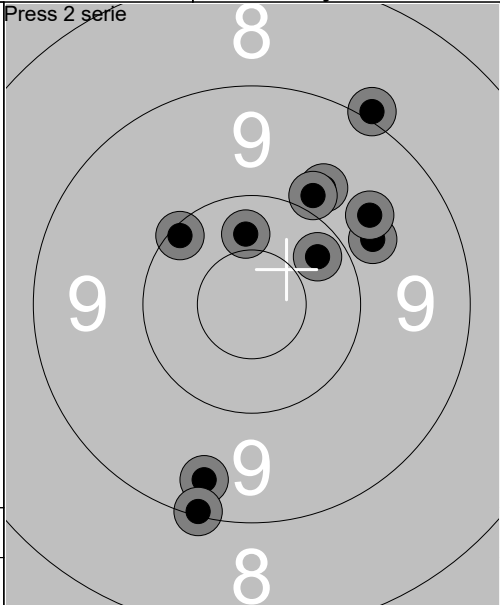

41.1s	10.4	↑
1:35m	9.8	↗
2:05m	9.8	↗
2:44m	9.4	↓
3:17m	9.0	↗
12.1s	9.7	↗
1:06m	10.3	↗
1:44m	10.1	↖
2:39m	9.1	↓
3:07m	9.9	↗
Serie	93 (0x)	
Total	189 (2x)	

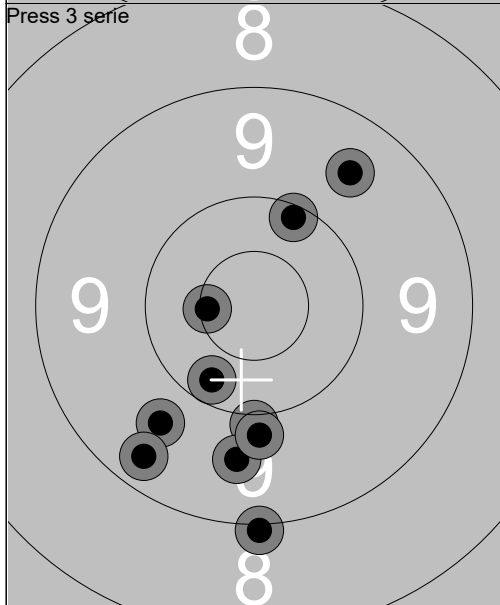

15.3s	10.0	↓
1:15m	9.7	↙
2:02m	9.6	↓
2:43m	9.0	↓
3:22m	10.2	↓
15.6s	10.6x	←
48.1s	9.4	↙
1:18m	9.9	↓
1:49m	9.6	↗
2:20m	10.2	↑
Serie	94 (1x)	
Total	283 (3x)	

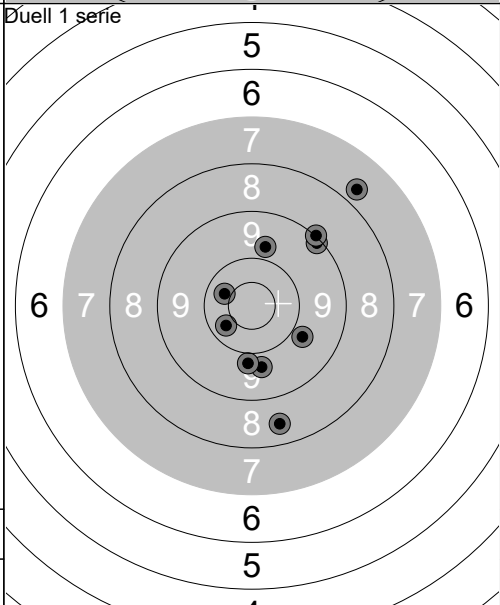

2.47s	10.3	↓
2.06s	9.7	↓
2.16s	10.0	↗
2.25s	9.2	↗
2.97s	10.0	↗
2.22s	10.4	↘
2.23s	10.6x	↙
2.35s	10.4	↓
2.00s	10.6x	↖
2.13s	10.3	↑
Serie	98 (2x)	
Total	381 (5x)	

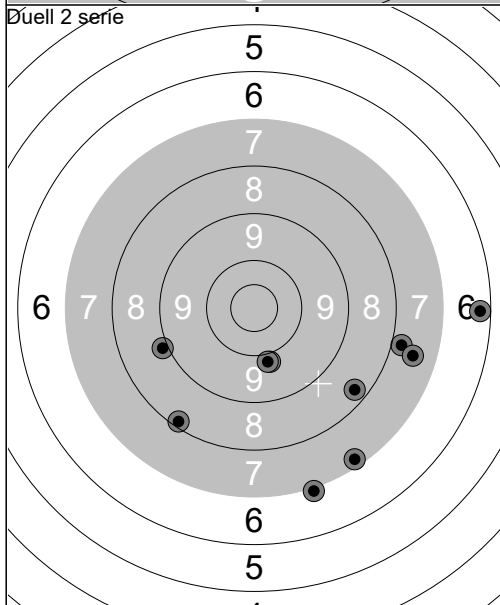

2.44s	8.7	↓
2.42s	9.3	→
2.31s	10.4	↓
2.42s	8.3	→
2.21s	9.5	↙
2.29s	9.1	→
2.31s	9.9	←
2.24s	10.4	↓
2.08s	9.6	↘
2.22s	8.9	↓
Serie	89 (0x)	
Total	470 (5x)	

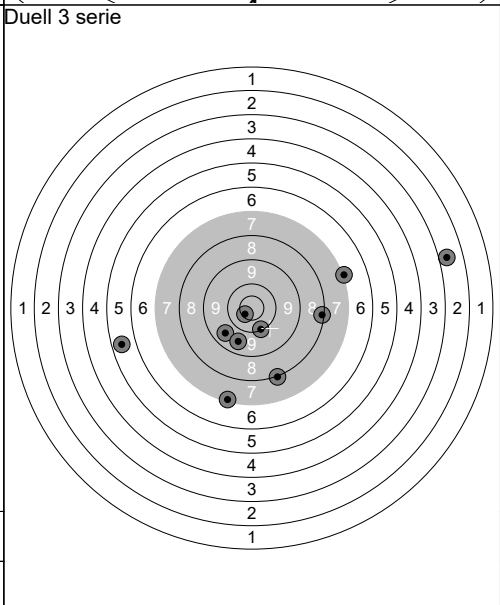

2.82s	6.0	→
2.27s	8.7	→
2.12s	10.2	↙
2.16s	9.4	↓
2.13s	10.2	↓
2.48s	8.8	↓
2.36s	7.8	←
2.22s	10.8x	↙
2.46s	10.5x	↓
1.91s	9.4	→
Serie	87 (2x)	
Total	557 (7x)	

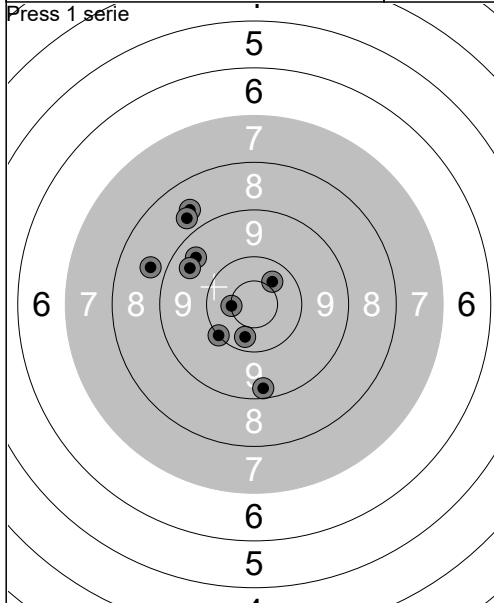

13.4s	10.4x ↗
44.7s	9.3 ↓
1:14m	8.7 ↙
1:44m	10.5x ←
2:29m	8.6 ↗
14.7s	8.7 ↗
44.8s	10.3 ↓
1:20m	10.1 ↙
2:00m	9.5 ↙
2:38m	9.5 ↙
Serie	91 (2x)
Total	91 (2x)

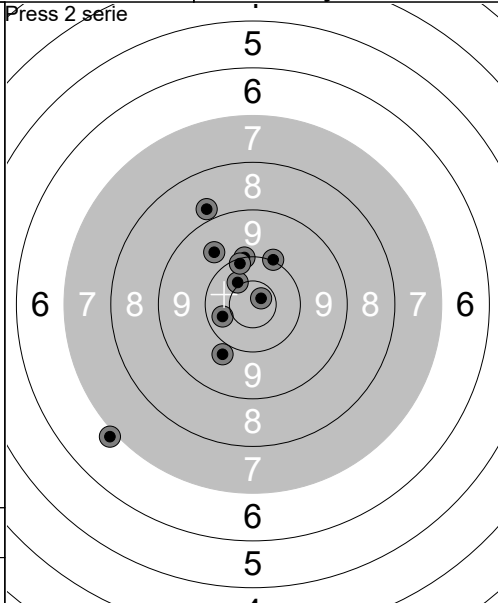

13.3s	10.3 ←
51.6s	10.0 ↗
1:29m	10.4x ↗
2:01m	10.0 ↗
2:34m	6.9 ↙
16.2s	9.7 ↗
50.5s	9.8 ↓
1:28m	10.8x ↗
2:03m	8.8 ↗
2:46m	10.1 ↗
Serie	92 (2x)
Total	183 (4x)

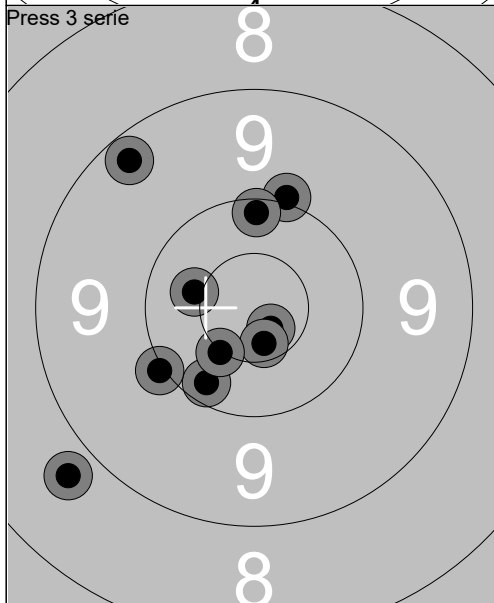

18.7s	10.2 ↓
54.0s	10.7x ↓
1:29m	9.3 ↗
2:49m	8.8 ↙
3:21m	10.0 ↗
15.5s	10.2 ↗
52.6s	10.4x ←
1:29m	10.0 ↙
2:05m	10.6x ↓
2:36m	10.5x ↙
Serie	97 (4x)
Total	280 (8x)

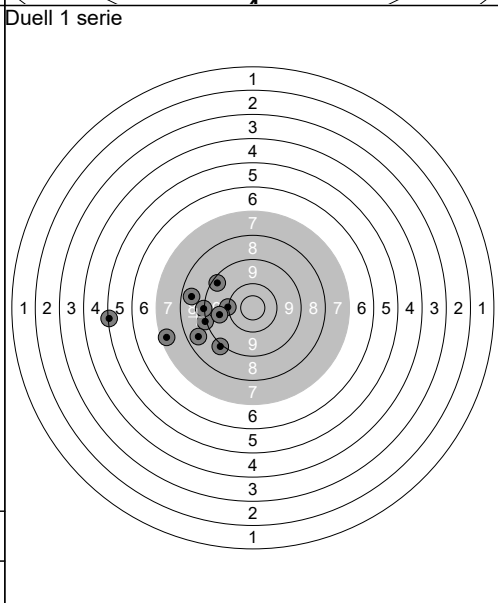

2.61s	10.5x ←
2.27s	7.5 ←
2.50s	10.1 ↙
2.33s	10.0 ←
2.17s	10.3 ←
2.50s	9.7 ←
2.34s	10.0 ←
2.25s	8.9 ←
2.56s	10.0 ↓
2.36s	9.7 ↙
Serie	93 (1x)
Total	373 (9x)

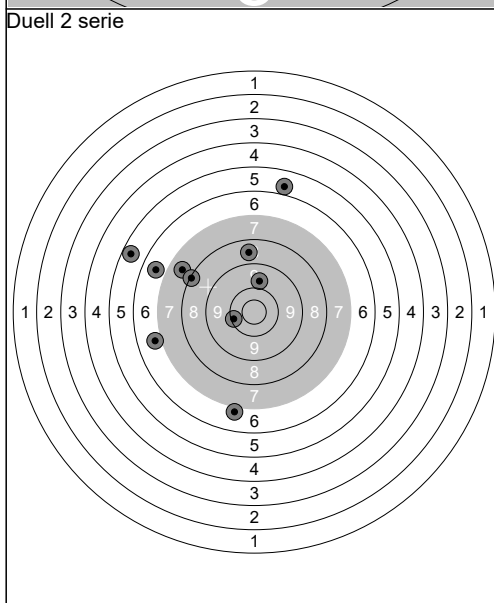

2.54s	7.7 ←
2.65s	9.1 ↙
2.29s	9.4 ↙
2.61s	9.7 ↗
2.36s	8.5 ↙
2.61s	8.6 ↓
2.11s	7.9 ↗
2.45s	10.5x ←
2.16s	8.6 ←
2.34s	10.3 ↗
Serie	85 (1x)
Total	458 (10x)

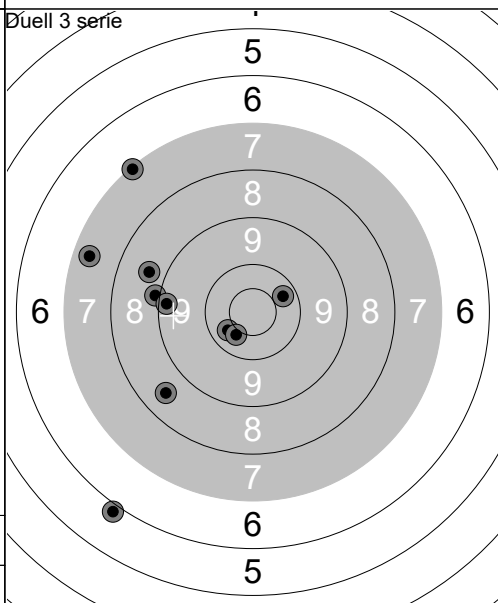

3.06s	9.0 ←
2.39s	9.7 ↙
2.23s	10.0 ←
2.06s	10.6x ↙
2.34s	10.1 ←
2.80s	10.7x ↙
2.39s	10.6x ↗
2.13s	8.0 ↙
2.42s	8.8 ↗
2.34s	9.8 ↙
Serie	93 (3x)
Total	551 (13x)

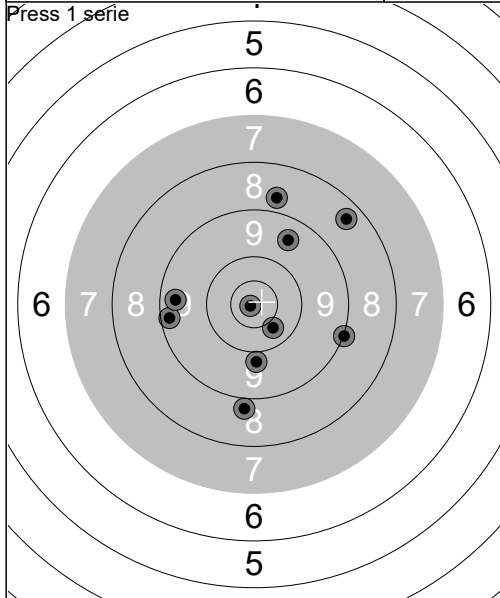

17.0s	9.3	←
44.7s	10.4	↘
1:19m	9.0	→
1:54m	10.9x	←
2:31m	8.4	↗
18.6s	9.5	↗
55.5s	8.8	↑
1:33m	8.8	↓
2:06m	9.8	↓
2:49m	9.4	←
Serie	89 (1x)	
Total	89 (1x)	

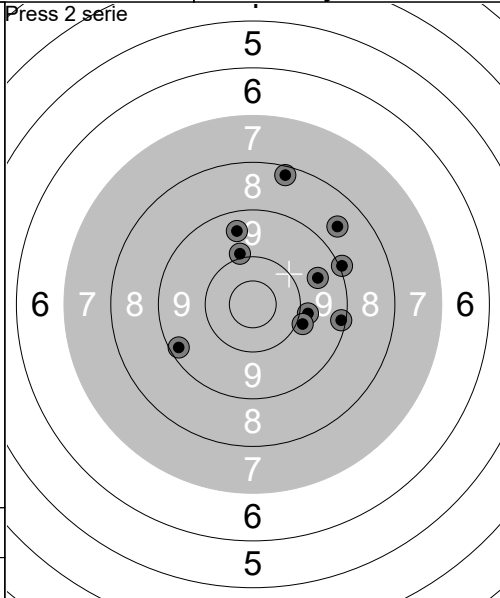

20.3s	9.2	→
55.0s	9.9	→
2:09m	8.6	↗
2:40m	9.0	↗
3:20m	9.9	→
18.0s	10.0	↑
1:00m	8.2	↑
1:37m	9.2	↙
2:18m	9.5	↑
2:53m	9.6	↗
Serie	89 (0x)	
Total	178 (1x)	

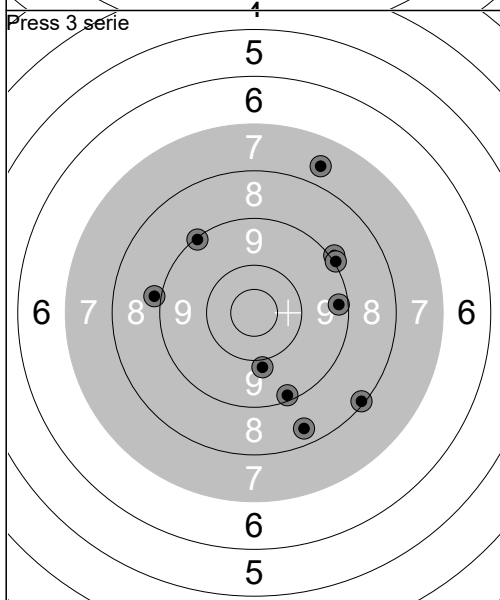

20.4s	8.4	↘
1:18m	7.7	↗
1:53m	9.2	↘
2:30m	9.9	↘
3:09m	8.1	↘
20.4s	9.0	↗
1:01m	9.3	→
1:40m	9.0	↗
2:22m	9.1	↗
3:02m	8.9	←
Serie	85 (0x)	
Total	263 (1x)	

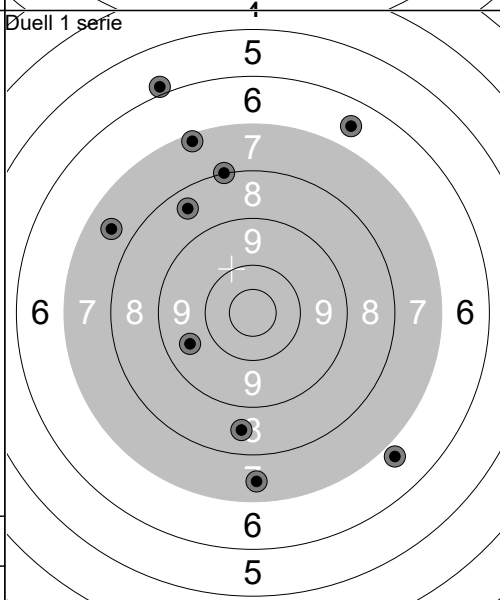

2.59s	9.0	↓
2.23s	9.7	↓
2.41s	10.2	↙
2.35s	9.4	↑
2.35s	8.5	↗
2.49s	8.0	↑
2.49s	8.6	↘
2.31s	9.1	↗
2.63s	9.6	↗
2.54s	8.9	↑
Serie	87 (0x)	
Total	350 (1x)	

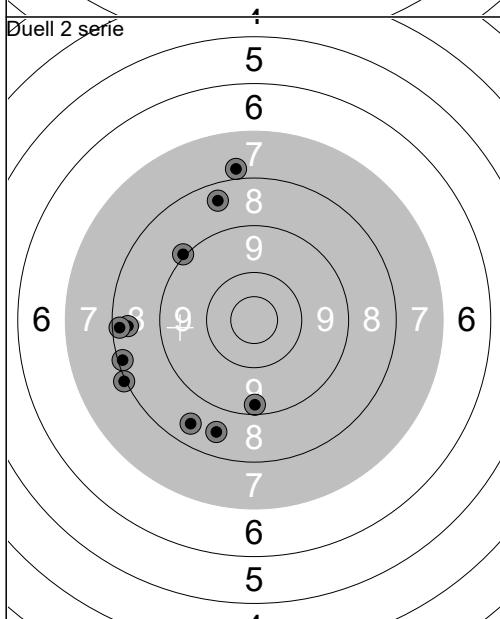

2.56s	10.0	↖
2.43s	9.6	←
2.31s	9.6	↑
2.52s	9.5	←
2.39s	9.4	←
2.79s	9.5	←
2.64s	9.7	↘
2.52s	9.3	↑
2.57s	9.7	↘
2.37s	10.1	↓
Serie	92 (0x)	
Total	442 (1x)	

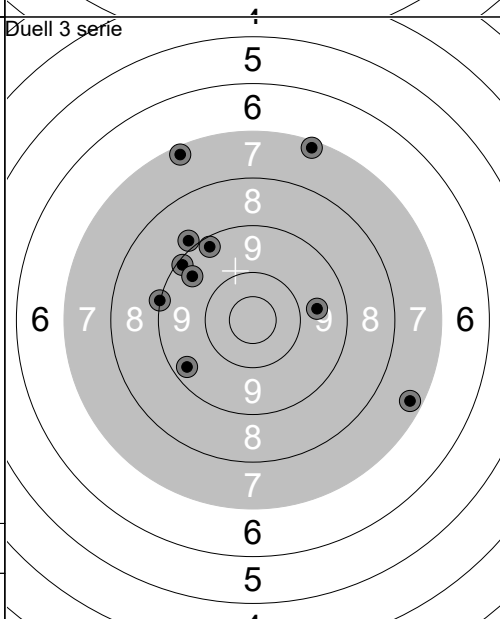

2.59s	10.0	←
2.67s	10.1	↗
2.57s	10.3	→
2.47s	8.9	↑
2.47s	8.9	↗
2.46s	9.9	↗
2.77s	10.2	↗
2.45s	8.9	→
2.42s	10.1	↗
2.63s	10.1	↙
Serie	93 (0x)	
Total	535 (1x)	

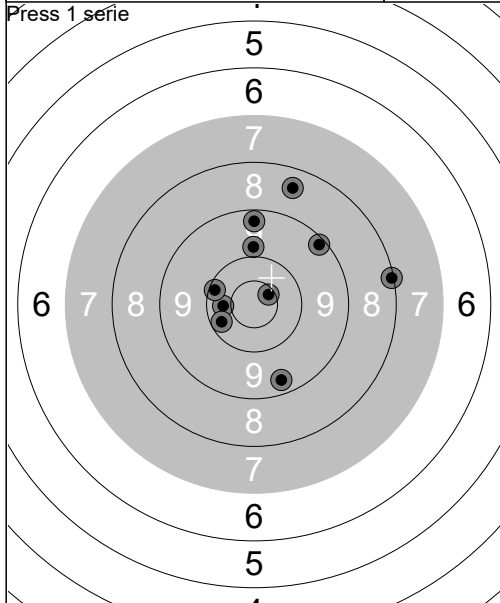

9.52s	9.8	↑
30.1s	8.1	→
51.7s	10.4	←
1:10m	10.2	←
1:34m	8.5	↑
8.59s	9.4	↓
25.4s	9.3	↑
45.9s	9.2	↗
1:09m	10.3	←
1:34m	10.6x	↗
Serie	92 (1x)	
Total	92 (1x)	

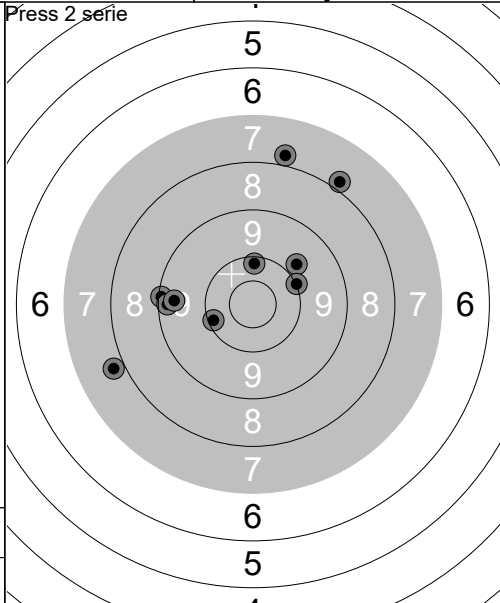

8.59s	7.8	←
35.3s	7.8	↑
1:00m	9.8	↗
1:19m	9.1	←
1:41m	9.3	←
12.0s	9.4	←
33.6s	7.9	↗
1:01m	10.0	↗
1:17m	10.1	←
1:36m	10.2	↑
Serie	87 (0x)	
Total	179 (1x)	

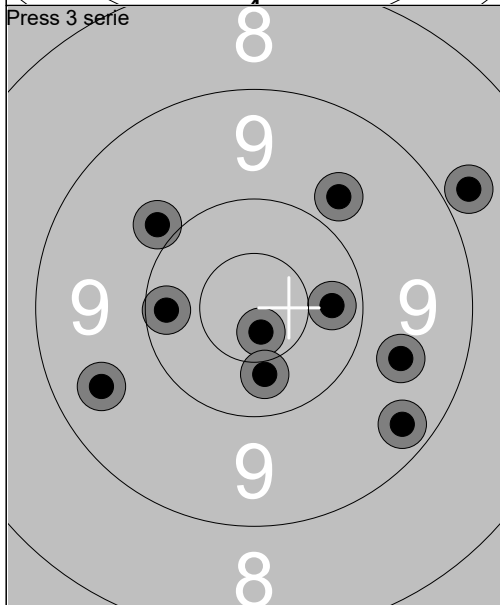

13.3s	10.3	→
34.5s	10.2	←
56.6s	10.7x	↓
1:19m	9.8	↗
1:41m	9.6	→
13.4s	9.5	←
33.9s	8.8	↗
1:01m	10.4	↓
1:22m	9.9	↗
1:46m	9.3	↘
Serie	93 (1x)	
Total	272 (2x)	

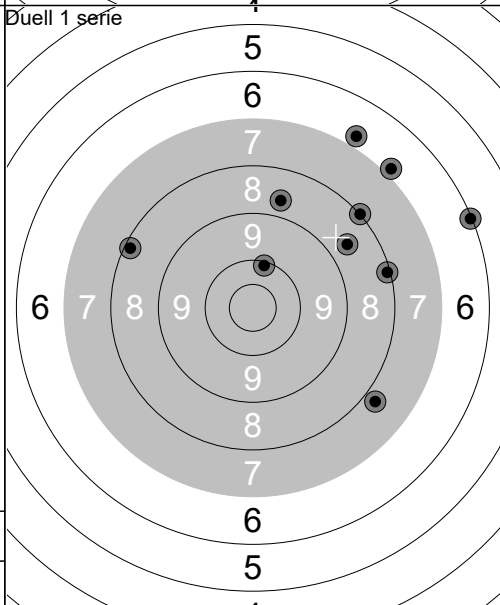

2.49s	9.5	←
2.40s	8.6	↗
2.41s	9.4	↗
2.39s	9.8	↑
2.49s	9.8	↗
2.40s	8.2	→
2.31s	10.5x	↑
2.20s	8.7	↗
2.52s	9.2	↘
2.50s	9.4	→
Serie	88 (1x)	
Total	360 (3x)	

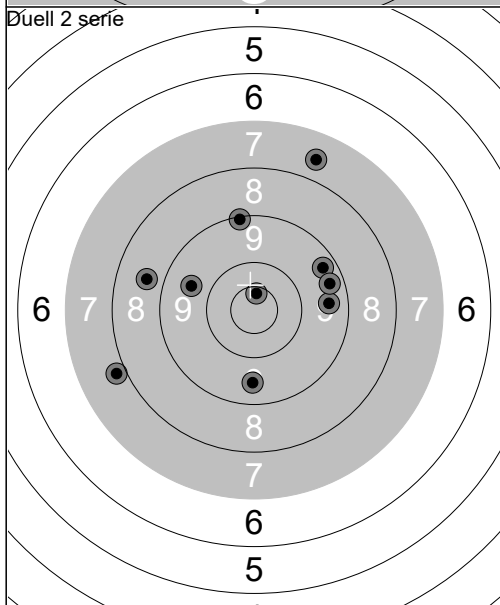

2.33s	10.2	↓
2.50s	9.3	←
2.45s	10.8x	↑
2.31s	10.2	→
2.10s	10.3	←
2.16s	9.8	←
2.70s	10.1	↗
2.54s	10.0	↑
2.54s	10.1	→
2.45s	9.1	↑
Serie	97 (1x)	
Total	457 (4x)	

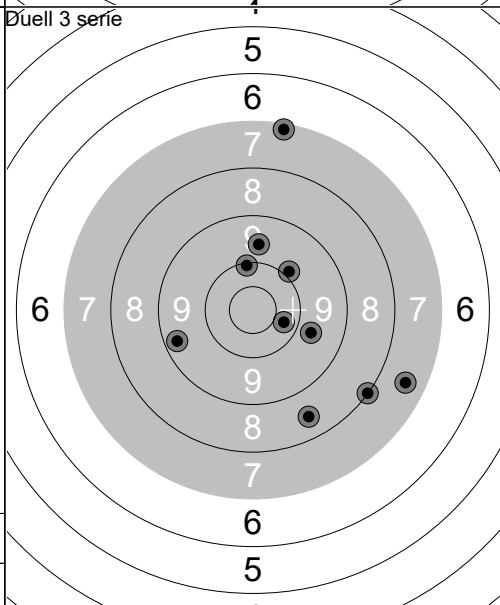

2.22s	10.6x	⇒
2.49s	10.3	↑
2.52s	9.0	⇒
2.50s	10.5x	↑
2.50s	9.7	↓
2.56s	10.4	↗
2.37s	10.1	←
2.41s	9.4	↘
2.29s	10.3	⇒
2.64s	8.8	↑
Serie	95 (2x)	
Total	552 (6x)	

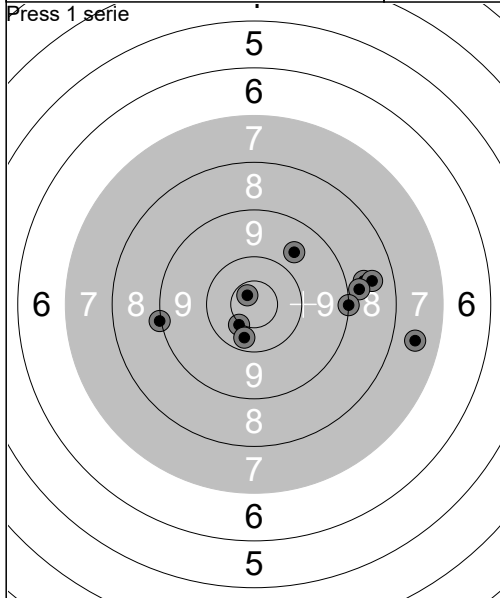

5.59s	8.7	→
37.5s	7.6	→
1:16m	10.5x	↙
1:39m	10.7x	↖
2:03m	8.5	→
6.13s	9.0	←
26.3s	8.8	→
48.5s	9.7	↗
1:10m	9.1	→
1:54m	10.3	↓
Serie	88 (2x)	
Total	88 (2x)	

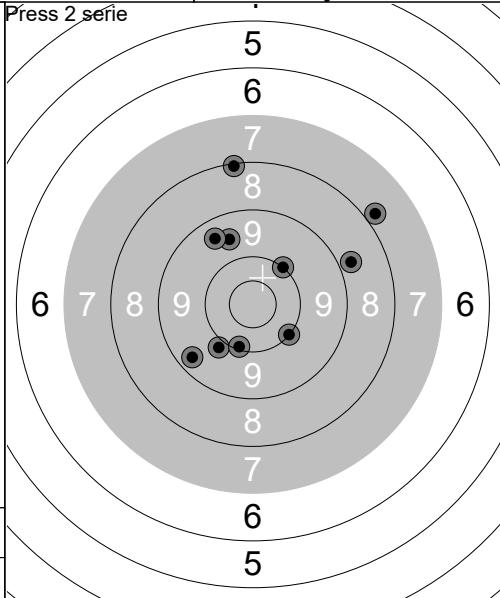

6.83s	10.0	↘
30.5s	7.8	↗
51.1s	8.1	↑
1:10m	9.6	↑
1:33m	9.9	↙
5.94s	10.1	↓
30.8s	8.8	→
49.8s	10.0	↗
1:14m	9.4	↙
1:42m	9.5	↖
Serie	89 (0x)	
Total	177 (2x)	

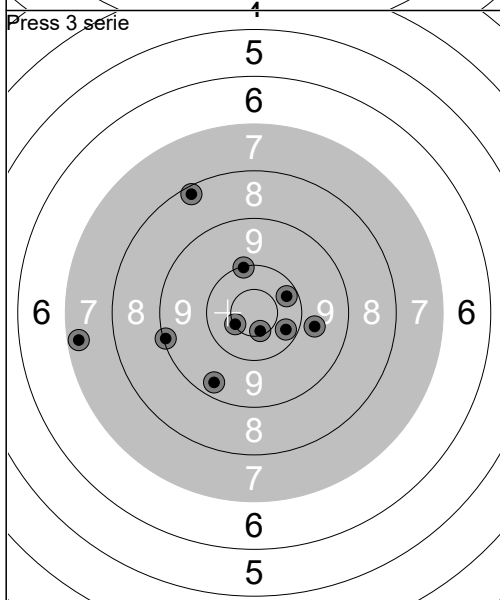

6.60s	8.2	↖
25.4s	9.8	→
56.5s	7.3	←
1:16m	10.6x	↓
1:39m	10.5x	↙
3.63s	9.1	←
25.8s	9.4	↙
48.1s	10.3	→
1:11m	10.3	↗
1:38m	10.1	↑
Serie	92 (2x)	
Total	269 (4x)	

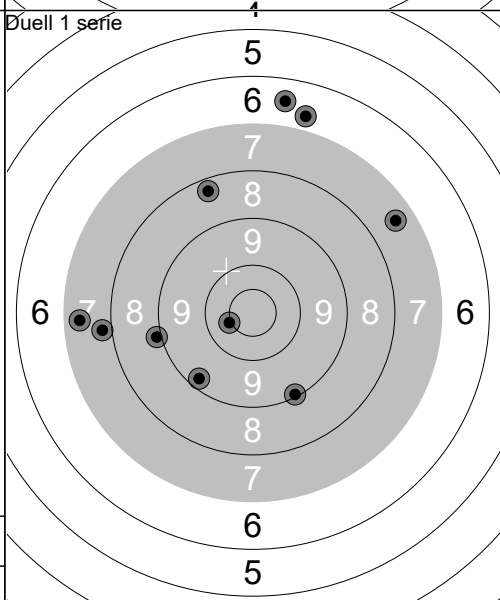

2.83s	8.4	↑
2.73s	9.0	↗
2.95s	10.0	←
2.73s	8.6	↑
2.89s	9.0	←
2.24s	9.6	↑
2.75s	10.1	↙
2.80s	9.3	←
2.78s	10.7x	↙
3.07s	10.0	↓
Serie	92 (1x)	
Total	361 (5x)	

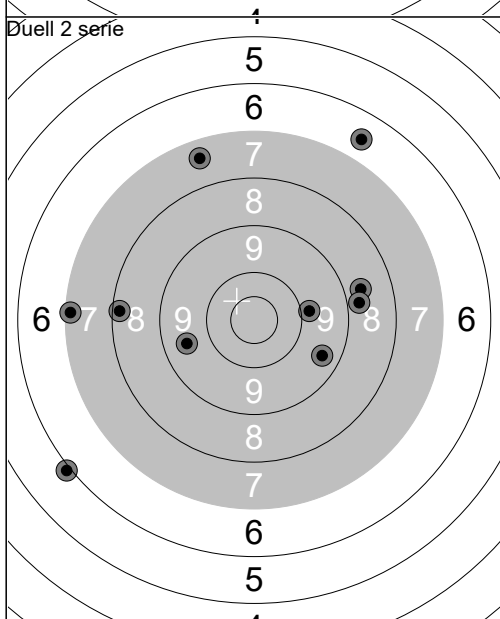

2.46s	9.0	↑
2.67s	10.4	→
2.70s	9.5	←
2.68s	10.2	→
2.71s	8.8	←
2.19s	8.5	↗
2.82s	9.8	→
2.57s	9.9	→
2.77s	8.1	↙
2.67s	10.2	←
Serie	90 (0x)	
Total	451 (5x)	

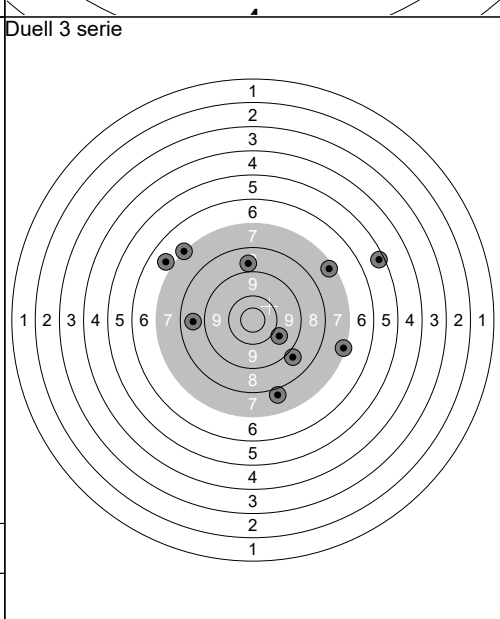

2.64s	8.7	↖
2.95s	9.7	←
3.02s	9.9	↘
2.82s	8.9	↗
2.78s	8.6	↖
2.82s	10.3	→
2.74s	9.2	↓
2.86s	8.8	→
3.00s	9.8	↑
2.70s	7.6	↗
Serie	85 (0x)	
Total	536 (5x)	

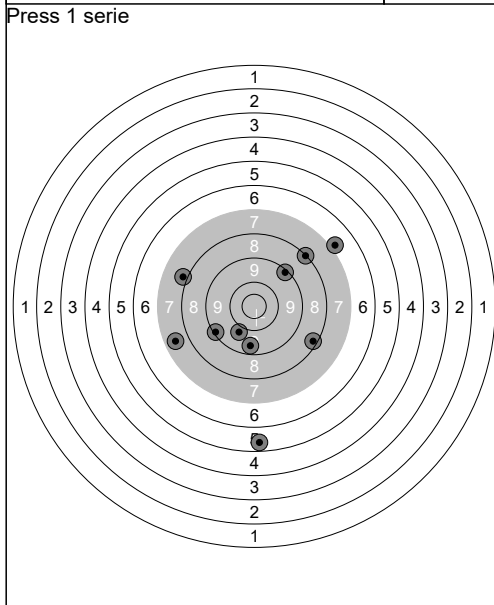

Press 2 serie

11.7s	7.2	↑
34.4s	10.4x	←
59.7s	7.4	↓
1:30m	10.2	↑
2:07m	8.1	←
8.42s	8.3	←
30.6s	8.6	↗
53.0s	8.5	←
1:18m	9.5	↓
2:18m	9.1	↗
Serie	84 (1x)	
Total	161 (1x)	

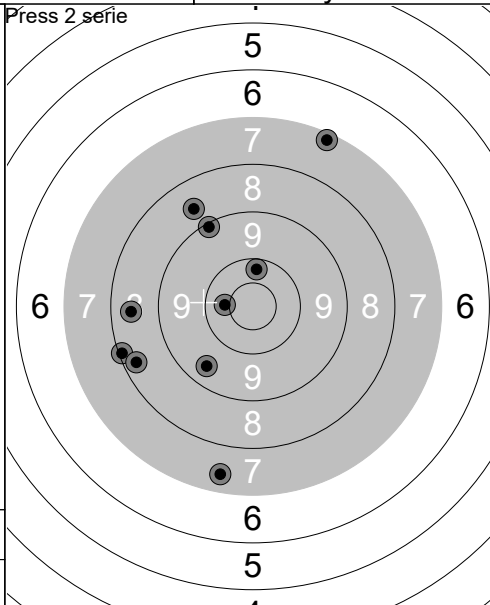

Duell 1 serie

2.47s	7.4	→
2.15s	7.2	↘
2.81s	10.8x	↖
2.70s	10.0	↘
2.73s	8.7	↓
2.95s	9.5	↓
2.71s	8.1	↓
2.69s	8.3	↓
2.71s	8.1	↓
2.89s	6.9	↓
Serie	81 (1x)	
Total	328 (3x)	

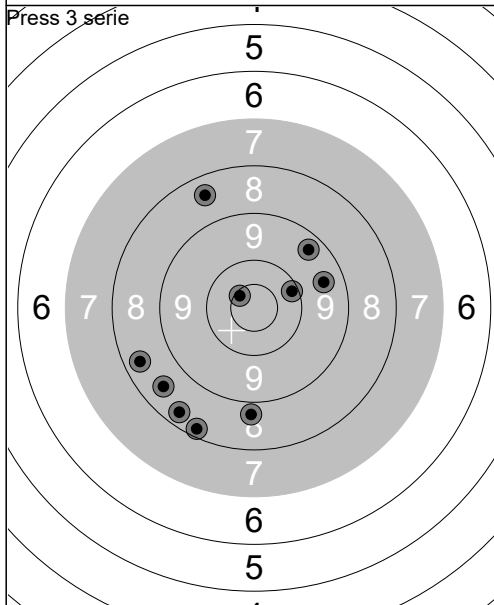

Duell 3 serie

2.22s	10.1	↑
2.73s	5.4	↓
2.69s	7.0	↘
2.66s	10.0	↓
3.02s	8.9	↓
2.45s	9.3	→
2.75s	9.7	↓
2.27s	8.2	↓
2.68s	10.0	←
2.50s	9.3	↓
Serie	85 (0x)	
Total	502 (3x)	

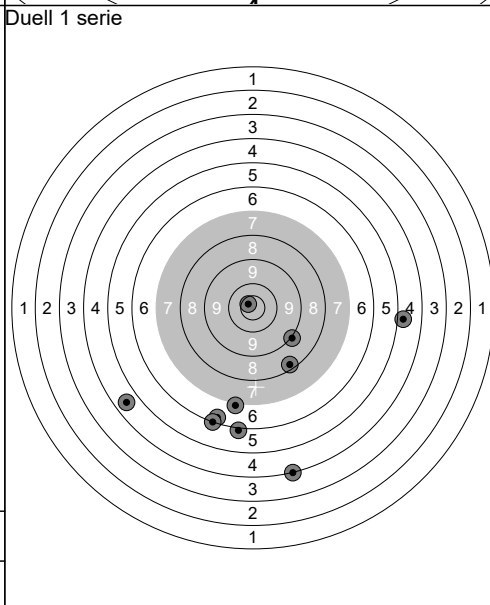

Duell 3 serie

2.22s	10.1	↑
2.73s	5.4	↓
2.69s	7.0	↘
2.66s	10.0	↓
3.02s	8.9	↓
2.45s	9.3	→
2.75s	9.7	↓
2.27s	8.2	↓
2.68s	10.0	←
2.50s	9.3	↓
Serie	85 (0x)	
Total	502 (3x)	

2 Sportpistol lö

Gällivare Pistolklubb

D 1

20.04.2024

Sista skottet

Umeå skytteallians

Press 1 serie

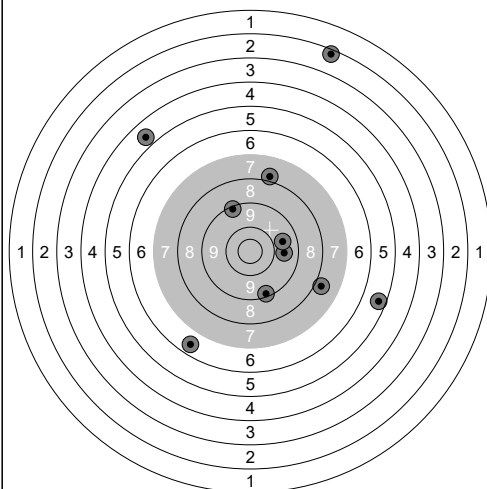

13.1s	2.2	↗
38.9s	9.2	↓
1:08m	9.7	→
1:39m	7.8	↘
1:59m	9.2	↗
10.8s	7.9	↗
50.1s	5.4	↘
1:15m	4.7	↗
1:35m	9.7	→
1:55m	6.5	↓
Serie	67	(0x)
Total	67	(0x)

Press 2 serie

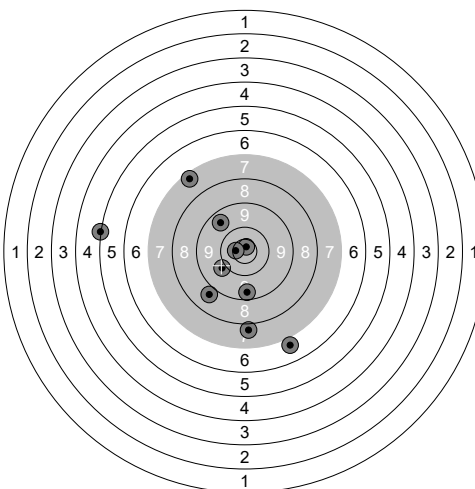

29.8s	7.8	↓
1:05m	5.0	←
1:32m	9.4	↓
2:04m	7.3	↗
2:42m	9.5	↗
9.68s	10.8x	↗
37.1s	9.9	↖
59.9s	8.7	↖
1:24m	6.8	↓
1:44m	10.6x	←
Serie	80	(2x)
Total	147	(2x)

Press 3 serie

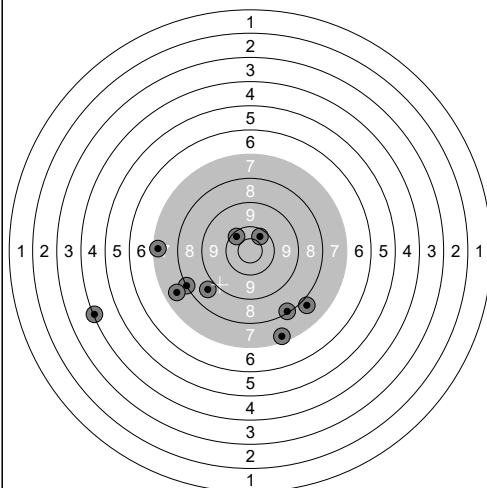

9.01s	7.3	↓
32.1s	8.1	↓
1:00m	4.1	←
1:25m	8.0	←
1:59m	10.3	↗
16.1s	7.8	↓
37.0s	8.7	↖
59.5s	7.6	↖
1:34m	7.2	←
2:03m	10.2	↗
Serie	76	(0x)
Total	223	(2x)

Duell 1 serie

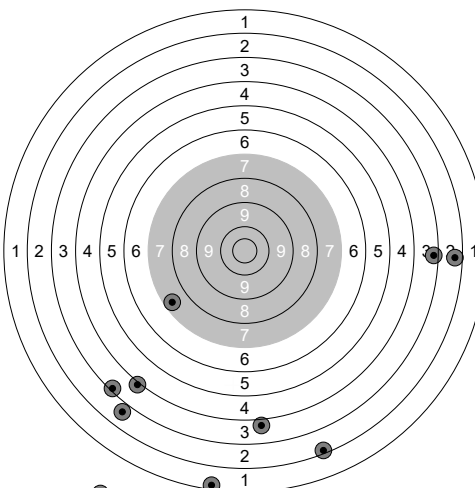

2.09s	6.4	→
2.25s	6.7	↓
2.06s	6.8	↖
2.35s	6.0	↖
2.34s	6.3	↖
2.15s	5.8	→
1.93s	0.0	↓
1.95s	5.1	↓
2.02s	9.0	↖
2.17s	5.7	↓
Serie	54	(0x)
Total	277	(2x)

Duell 2 serie

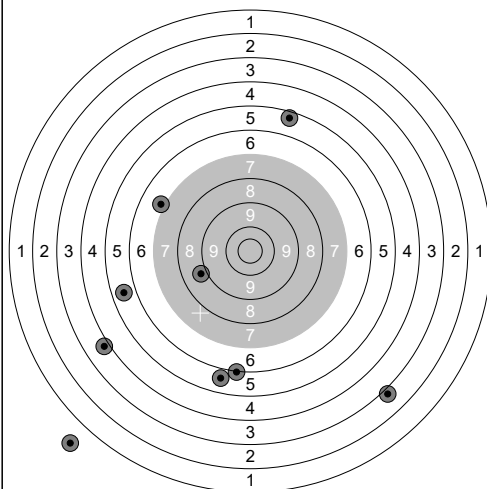

2.19s	7.8	←
2.29s	7.7	↗
2.22s	6.1	↓
2.37s	7.9	↓
2.14s	8.7	↖
2.22s	8.1	↓
2.23s	0.0	↖
--		
1.96s	6.8	↖
2.27s	9.9	↖
Serie	58	(0x)
Total	335	(2x)

Duell 3 serie

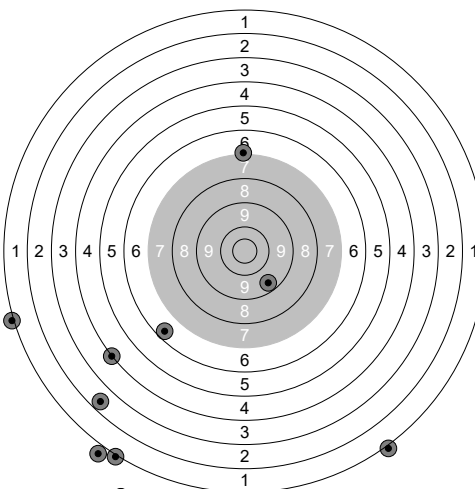

2.50s	6.9	↖
2.43s	0.0	↖
2.34s	5.0	↖
2.45s	8.3	↖
2.25s	10.2	↓
2.38s	8.7	↗
2.21s	5.0	↓
2.08s	5.0	←
2.12s	5.9	↖
1.94s	0.0	↓
Serie	52	(0x)
Total	387	(2x)

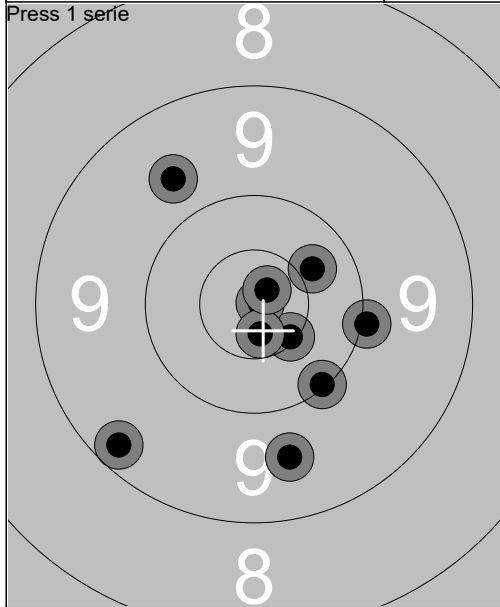

15.1s	10.0	→
38.6s	9.3	↙
1:11m	9.6	↓
1:36m	10.5x	↘
2:12m	10.9x	→
14.5s	10.4	↗
37.4s	9.7	↖
1:40m	10.1	↓
2:10m	10.7x	↘
2:42m	10.8x	↗
Serie	97 (4x)	
Total	97 (4x)	

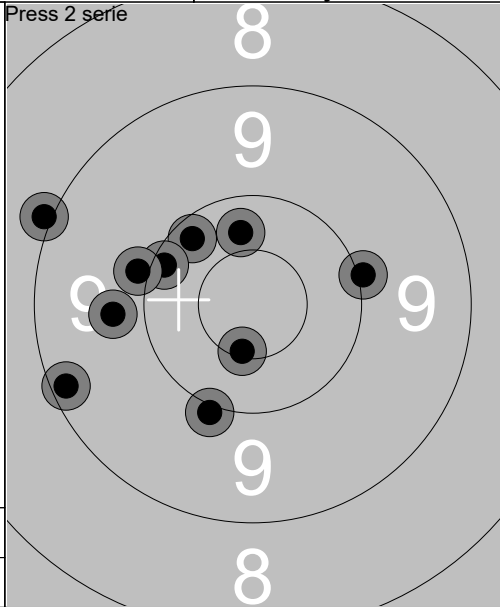

20.2s	10.2	↖
53.4s	10.2	↙
1:22m	10.0	↓
1:54m	10.6x	↘
3:07m	9.2	↙
18.3s	10.3	↑
46.6s	9.8	←
1:19m	10.0	→
1:53m	9.0	↙
2:35m	10.0	←
Serie	97 (1x)	
Total	194 (5x)	

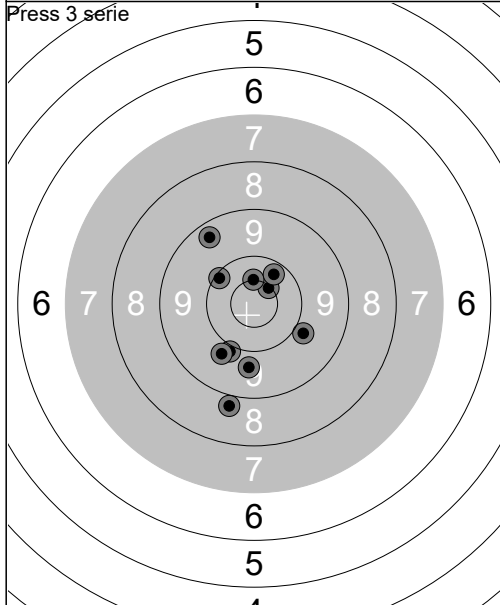

16.7s	9.9	↘
49.4s	8.8	↓
1:21m	10.1	↖
1:52m	10.5x	↗
2:21m	9.8	→
15.7s	9.4	↗
48.2s	10.5x	↑
1:55m	9.7	↓
2:27m	9.8	↙
3:46m	10.3	↗
Serie	93 (2x)	
Total	287 (7x)	

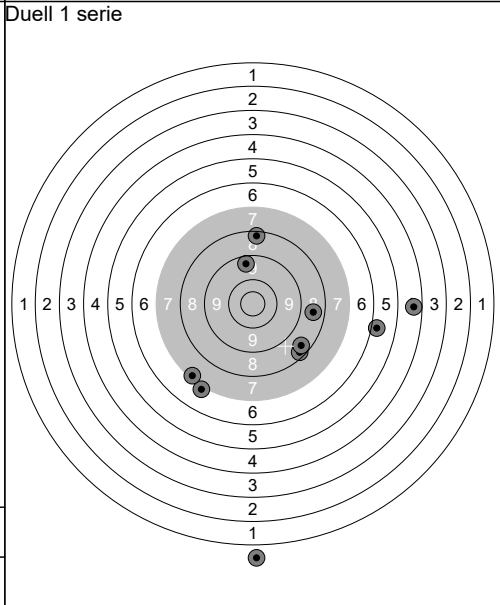

2.40s	8.7	↘
2.54s	8.0	→
2.22s	9.7	→
2.23s	8.8	↙
2.27s	10.1	↑
2.42s	9.5	↘
2.45s	7.1	→
2.44s	0.0	↓
2.12s	9.6	↘
2.21s	9.5	↑
Serie	77 (0x)	
Total	364 (7x)	

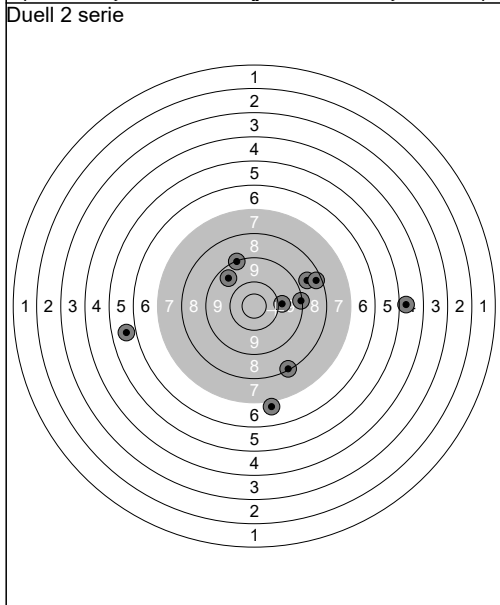

2.49s	10.4	→
2.34s	9.7	↗
2.18s	7.9	←
2.42s	10.0	↖
2.39s	9.5	↗
2.38s	8.6	↘
2.24s	10.2	↗
2.19s	9.4	↘
2.21s	7.3	→
2.24s	10.0	→
Serie	89 (0x)	
Total	453 (7x)	

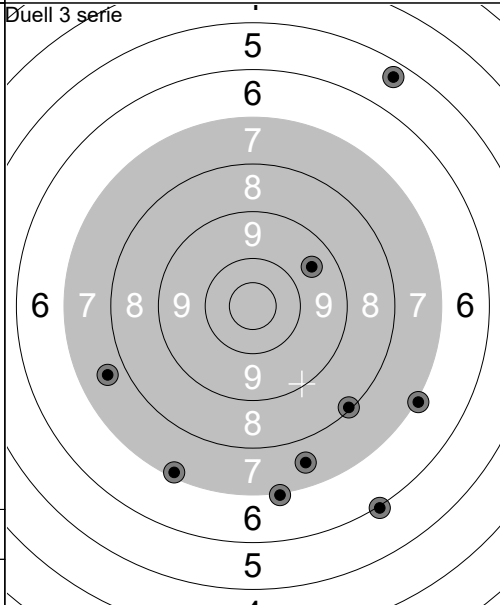

2.58s	8.7	↘
2.37s	9.1	↙
2.61s	8.7	↓
2.58s	9.4	↘
2.62s	8.1	↘
2.62s	8.8	↘
0.00s	8.0	
2.34s	9.1	↓
2.44s	7.7	↗
2.36s	10.2	↗
Serie	84 (0x)	
Total	537 (7x)	

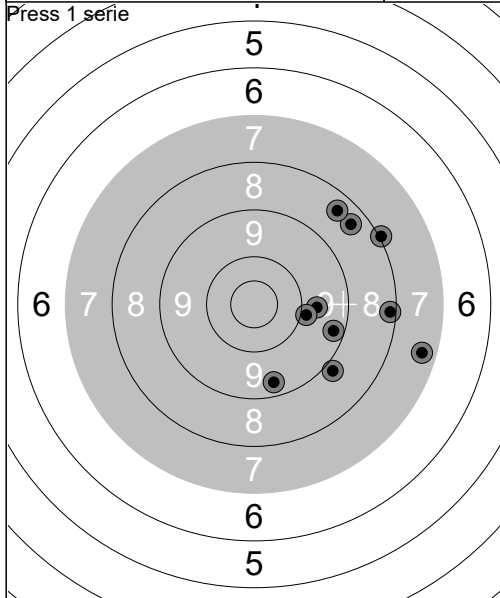

8.02s	7.4	➔
29.3s	8.4	↗
55.7s	9.7	➔
1:14m	8.0	↗
1:42m	8.9	↘
4.78s	9.9	➔
17.6s	8.2	➔
38.0s	8.4	↗
50.0s	9.3	➔
1:17m	9.4	↘
Serie	83 (0x)	
Total	83 (0x)	

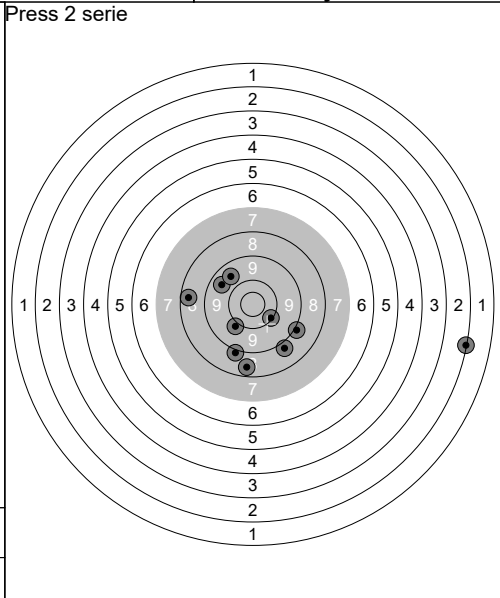

18.6s	10.1	↘
41.8s	9.9	↙
53.4s	9.0	➔
1:22m	2.1	➔
1:44m	8.9	↘
5.09s	8.8	↘
16.1s	9.5	↗
35.0s	9.6	↗
56.8s	8.4	↘
1:21m	8.4	←
Serie	80 (0x)	
Total	163 (0x)	

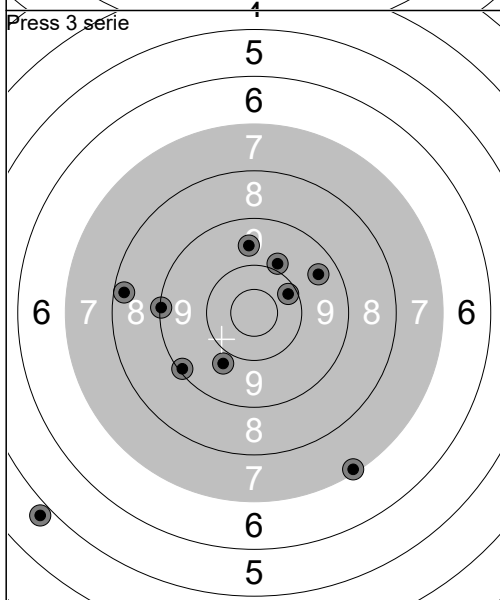

5.92s	9.8	↙
9.44s	7.1	↘
12.7s	9.6	↑
14.8s	4.8	↙
17.7s	9.9	↗
6.92s	8.3	←
21.9s	9.5	↗
44.2s	9.1	↙
1:03m	9.1	←
1:22m	10.2	↗
Serie	83 (0x)	
Total	246 (0x)	

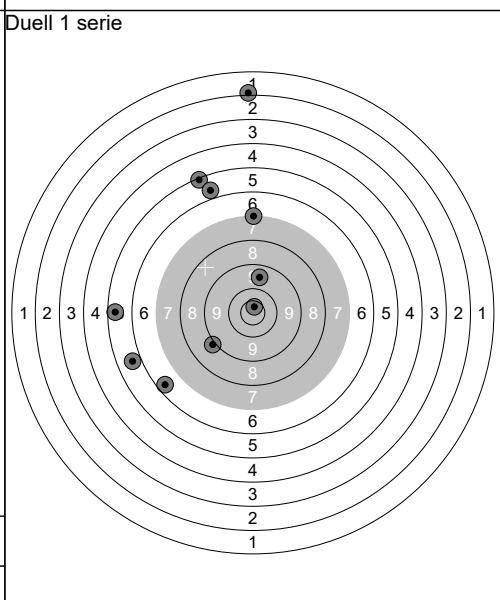

2.13s	7.7	←
1.83s	10.2	↑
1.84s	10.0	↙
1.91s	5.6	↑
1.84s	8.3	↙
1.90s	7.9	←
1.63s	8.8	↑
2.06s	7.6	↗
1.68s	10.8x	↑
1.99s	7.9	↗
Serie	79 (1x)	
Total	325 (1x)	

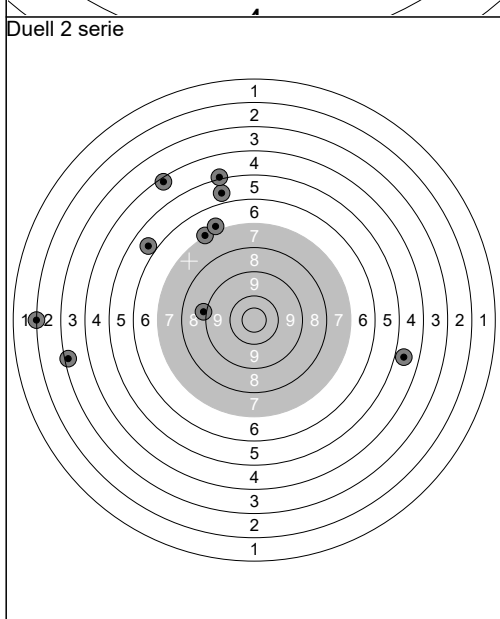

1.87s	7.3	➔
1.92s	7.9	↑
1.81s	5.6	←
2.31s	8.7	↗
2.27s	6.4	←
1.94s	7.0	↗
2.11s	7.9	↗
2.00s	7.5	↑
1.90s	8.7	↗
2.02s	9.9	←
Serie	71 (0x)	
Total	396 (1x)	

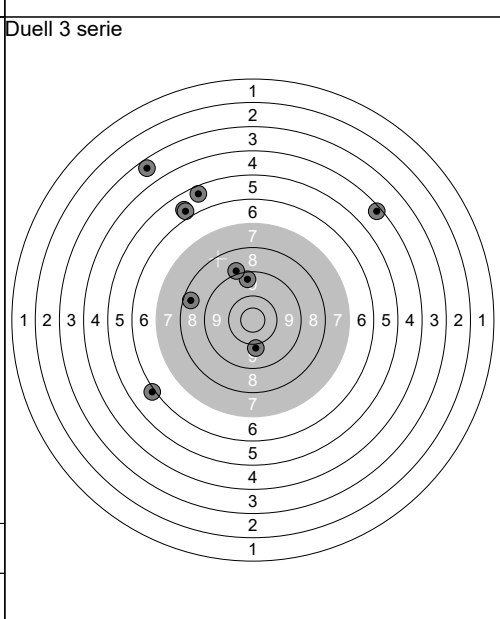

2.36s	10.4	↘
2.41s	10.1	↑
2.57s	7.7	↗
2.50s	9.9	↑
2.16s	7.9	↗
2.19s	9.6	←
1.81s	8.1	↙
1.80s	6.5	↗
1.98s	8.0	↗
2.12s	7.0	↗
Serie	81 (0x)	
Total	477 (1x)	

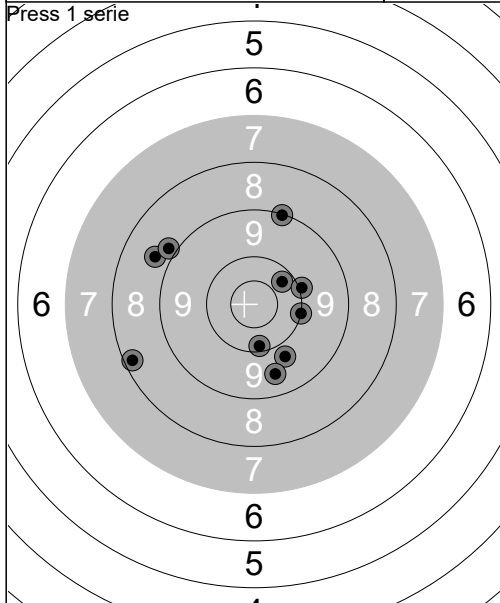

3.31s	10.0	→
26.8s	9.8	↓
49.1s	9.5	↓
1:20m	10.3	↗
1:44m	8.7	↖
8.65s	8.9	↗
27.9s	9.1	↗
48.5s	10.2	↓
1:11m	10.0	→
1:36m	8.2	←
Serie	91 (0x)	
Total	91 (0x)	

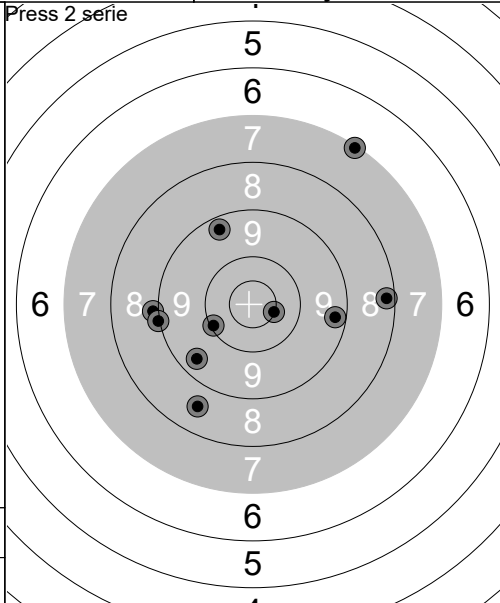

8.35s	8.9	←
28.3s	9.4	↙
50.7s	8.2	→
1:10m	9.3	↗
1:32m	10.1	←
7.50s	7.1	↗
24.1s	9.3	→
41.6s	9.0	←
1:02m	8.6	↓
1:21m	10.5x	→
Serie	87 (1x)	
Total	178 (1x)	

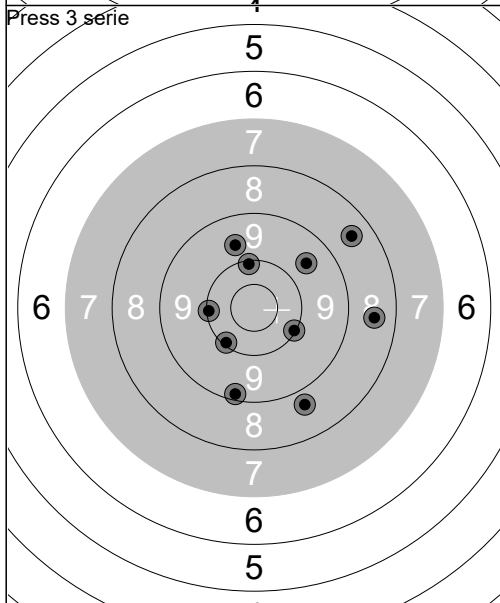

9.51s	10.1	←
33.6s	8.7	↓
52.0s	10.1	↑
1:16m	10.1	↙
1:40m	10.1	↘
9.25s	9.7	↗
30.6s	9.2	↓
51.7s	9.6	↗
1:13m	8.5	→
1:31m	8.5	↗
Serie	91 (0x)	
Total	269 (1x)	

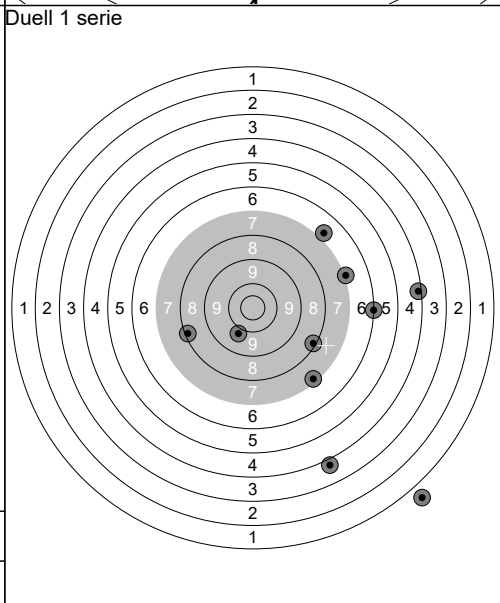

2.52s	9.5	↘
2.91s	7.0	→
2.65s	9.5	←
2.61s	8.1	→
2.61s	8.7	↘
2.54s	8.8	↘
2.82s	8.6	↗
2.88s	6.7	↓
2.73s	10.4	↙
2.96s	0.0	↘
Serie	73 (0x)	
Total	342 (1x)	

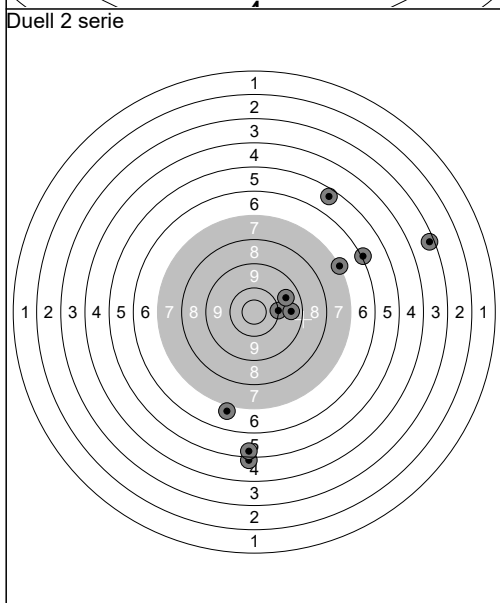

2.72s	7.7	↗
2.83s	7.4	↓
2.56s	8.1	↘
2.46s	7.7	↓
2.66s	10.5x	→
2.62s	6.4	→
2.71s	8.8	↗
2.68s	10.2	→
2.65s	8.6	↓
2.66s	10.3	↘
Serie	81 (1x)	
Total	423 (2x)	

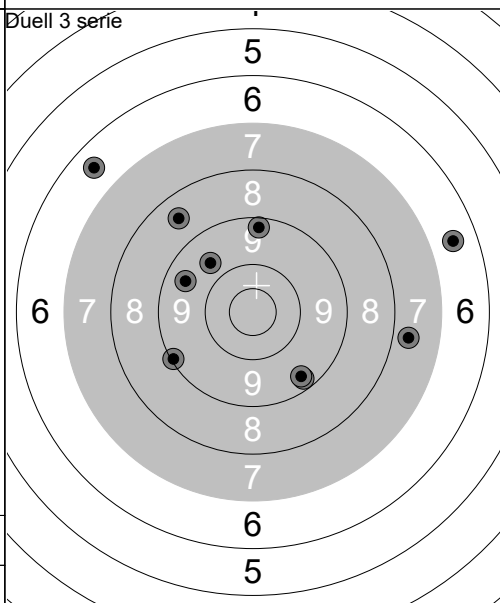

2.76s	10.1	↑
2.80s	10.2	↖
2.96s	10.1	↘
2.52s	9.7	↗
2.66s	8.4	↖
2.73s	10.0	←
2.75s	8.5	↘
2.68s	10.1	↓
2.78s	9.2	→
2.54s	10.3	↗
Serie	94 (0x)	
Total	517 (2x)	

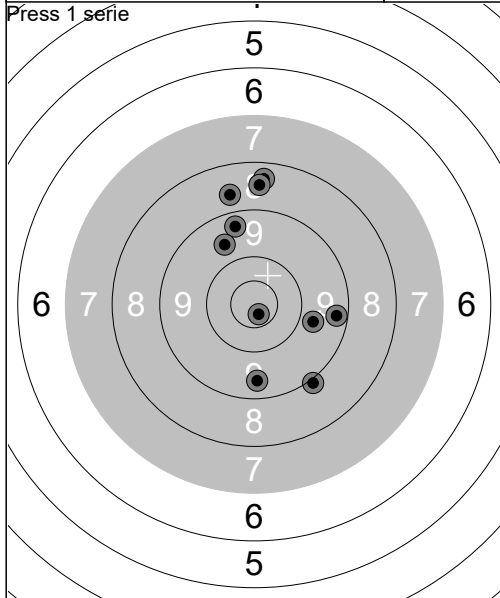

11.6s	9.3	→
33.3s	9.4	↓
56.2s	9.8	→
1:25m	8.7	↑
2:26m	9.4	↑
45.4s	8.4	↑
1:06m	8.5	↑
1:33m	9.0	↓
2:01m	9.6	↑
3:12m	10.8x	↓
Serie	88 (1x)	
Total	88 (1x)	

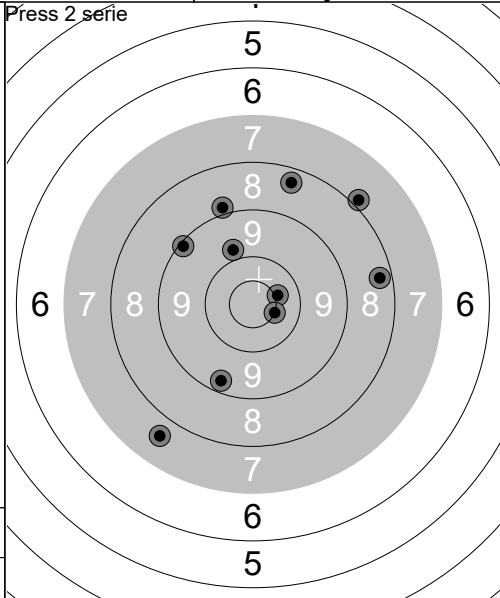

12.7s	8.9	↑
37.7s	8.4	↑
1:01m	9.8	↑
1:29m	10.4x	→
1:59m	7.7	↓
7.37s	9.3	↓
33.9s	7.9	↗
58.0s	9.1	↖
1:28m	10.5x	→
2:33m	8.3	→
Serie	85 (2x)	
Total	173 (3x)	

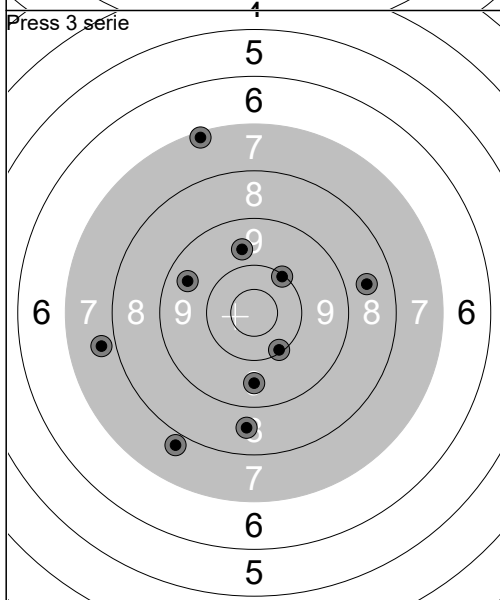

9.02s	9.5	←
40.3s	10.1	↗
1:12m	9.6	↓
1:48m	7.8	↓
2:31m	10.1	↓
13.3s	8.6	→
1:00m	7.7	←
1:21m	7.2	↑
2:36m	8.6	↓
3:14m	9.7	↑
Serie	84 (0x)	
Total	257 (3x)	

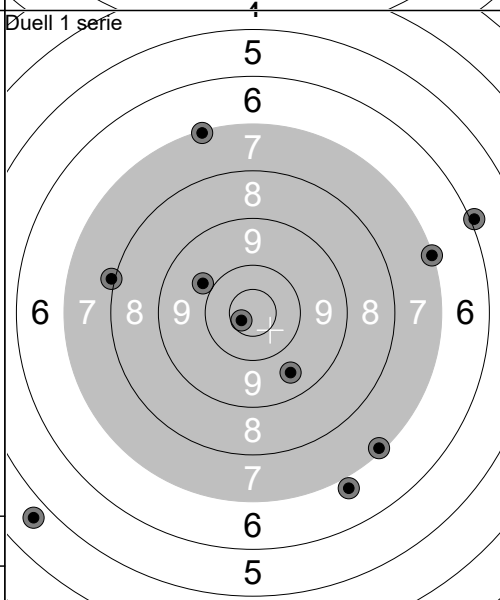

2.49s	10.4	↖
2.86s	9.3	←
2.16s	10.8x	↙
2.42s	8.6	↓
2.50s	8.8	→
2.49s	8.8	↓
2.49s	8.8	↑
2.48s	7.3	↙
2.40s	8.1	↗
2.52s	10.2	↓
Serie	86 (1x)	
Total	343 (4x)	

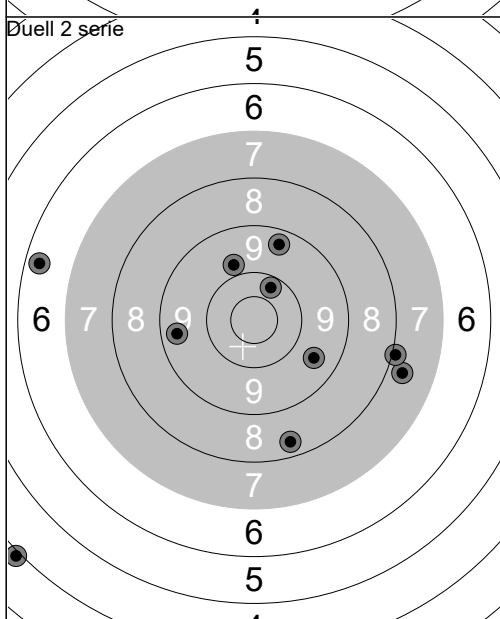

2.40s	10.4	↑
2.38s	8.3	←
2.56s	6.8	↙
2.60s	9.2	→
2.48s	10.2	↑
2.41s	10.2	←
2.78s	10.6x	↗
2.80s	9.3	→
2.73s	10.2	↘
2.33s	9.6	↓
Serie	91 (1x)	
Total	434 (5x)	

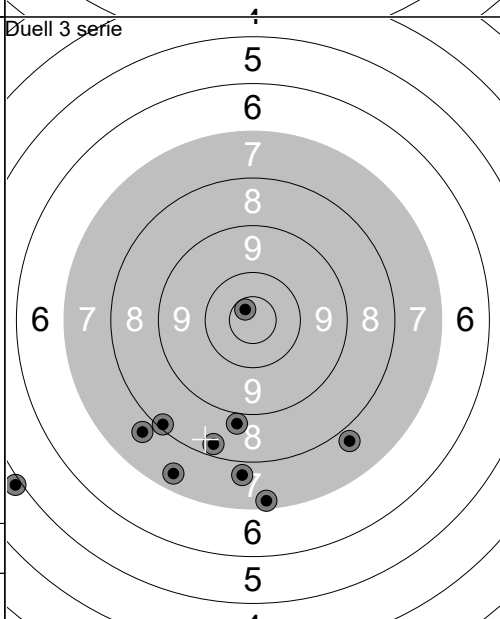

2.42s	10.8x	↖
2.83s	9.5	↓
2.69s	9.2	↘
2.50s	9.9	↓
2.88s	9.2	↓
2.29s	7.4	↙
2.43s	8.9	↓
3.02s	9.0	↓
2.36s	9.2	↙
2.40s	9.4	↙
Serie	88 (1x)	
Total	522 (6x)	

2 Sportpistol lö

Gällivare Pistolklubb

H 2

20.04.2024

Sista skottet

Umeå skytteallians

Press 1 serie

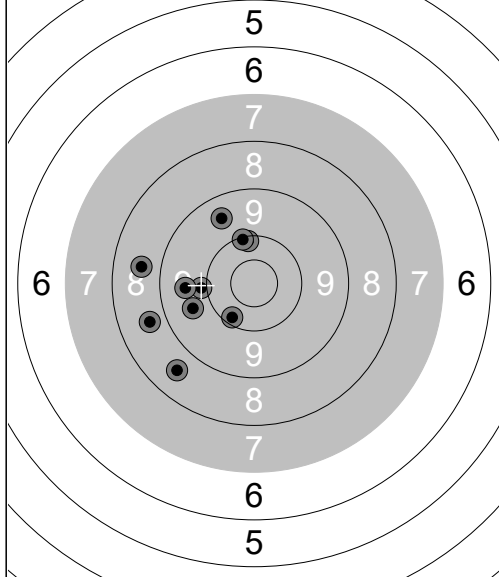

Press 2 serie

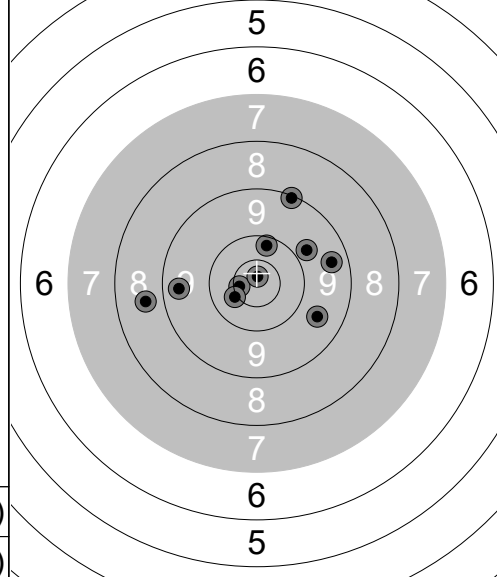

Press 3 serie

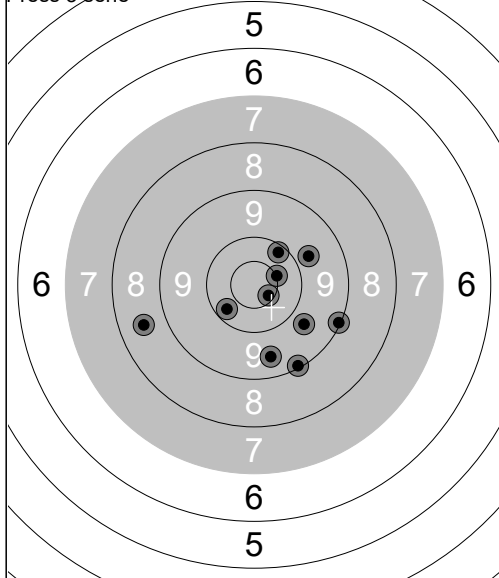

Duell 1 serie

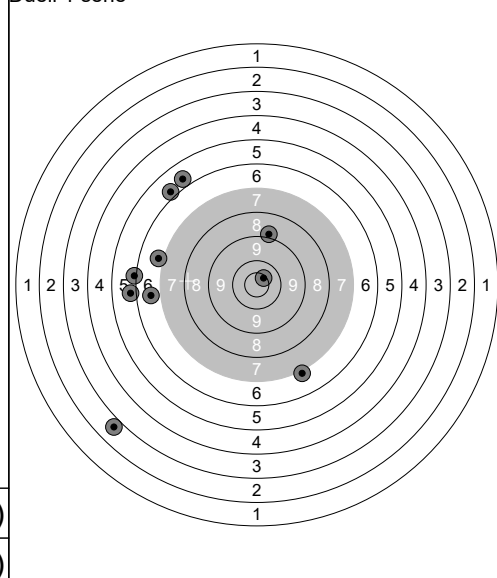

Duell 2 serie

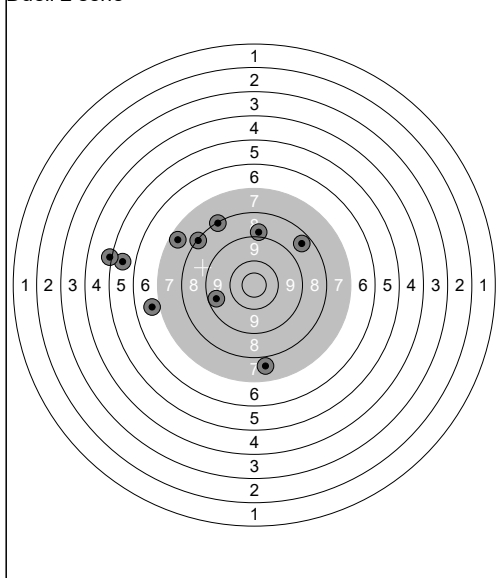

Duell 3 serie

