

1:	9.3	→
2:	10.2	↑
3:	10.2	↖
4:	8.5	←
5:	10.5x	←
6:	10.5x	↗
7:	9.6	↓
8:	10.2	↑
9:	8.8	↓
10:	10.4x	↙
Serie		94 (3x)
Total		94 (3x)

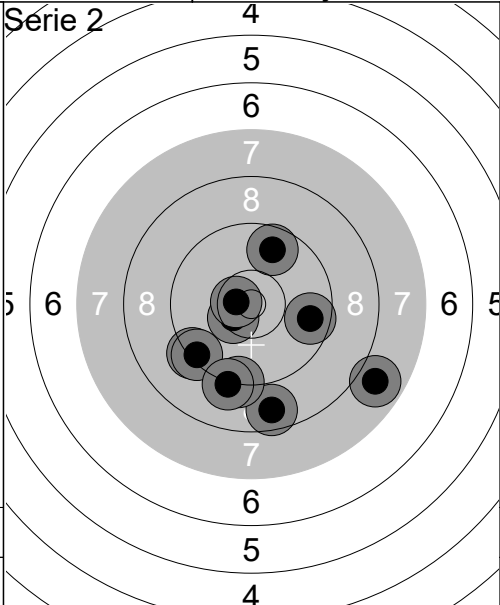

1:	8.6	↓
2:	7.8	↘
3:	9.3	↙
4:	10.5x	↙
5:	9.3	↓
6:	9.4	↙
7:	9.2	↓
8:	9.7	→
9:	10.6x	←
10:	9.7	↑
Serie		89 (2x)
Total		183 (5x)

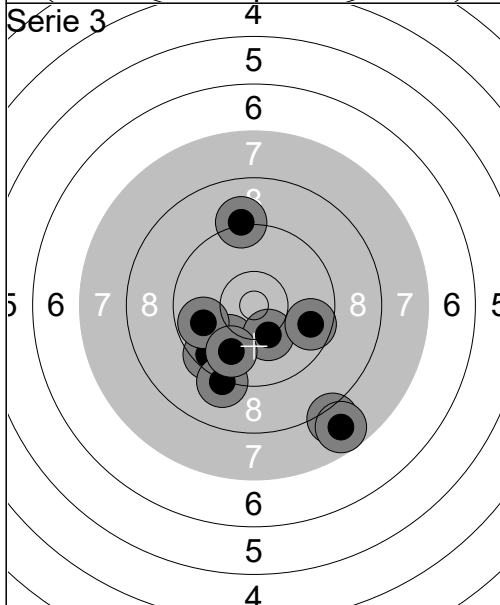

1:	9.2	↑
2:	10.0	↙
3:	8.0	↓
4:	10.2	↓
5:	9.5	↙
6:	9.8	←
7:	9.7	→
8:	7.8	↓
9:	9.2	↓
10:	9.8	↓
Serie		89 (0x)
Total		272 (5x)

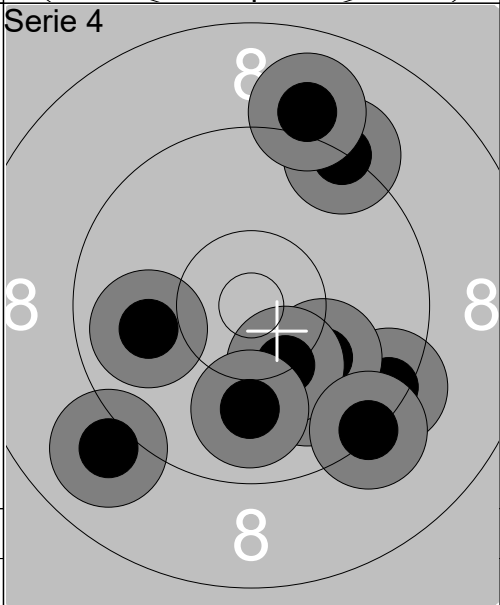

1:	10.0	↓
2:	9.4	→
3:	10.1	↘
4:	9.9	←
5:	9.0	↙
6:	10.3	↓
7:	9.3	↘
8:	9.2	↗
9:	9.9	↓
10:	9.0	↑
Serie		93 (0x)
Total		365 (5x)

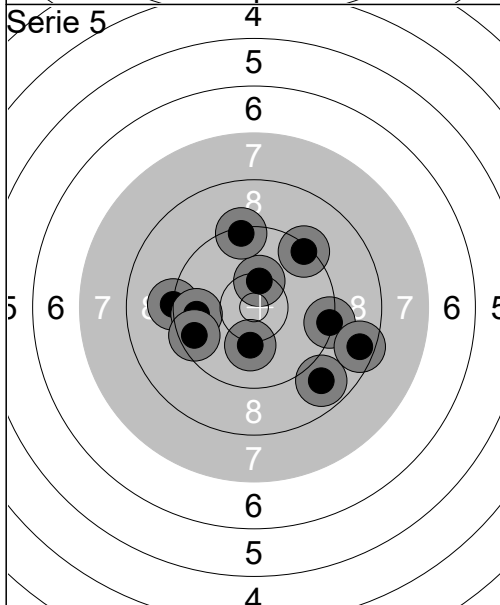

1:	9.2	←
2:	8.8	↘
3:	9.4	↗
4:	9.7	←
5:	9.6	←
6:	9.3	→
7:	10.4x	↑
8:	8.5	→
9:	10.1	↓
10:	9.3	↑
Serie		90 (1x)
Total		455 (6x)

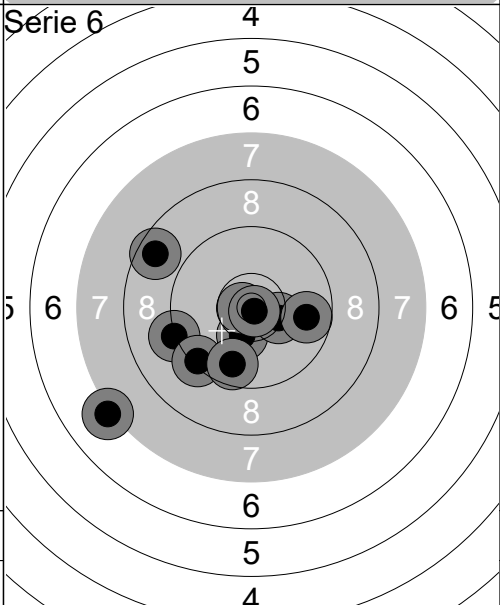

1:	10.3	↓
2:	9.2	←
3:	9.3	↙
4:	8.6	↖
5:	10.8x	←
6:	9.7	↓
7:	10.3	→
8:	10.8x	↘
9:	7.1	↙
10:	9.7	→
Serie		91 (2x)
Total		546 (8x)

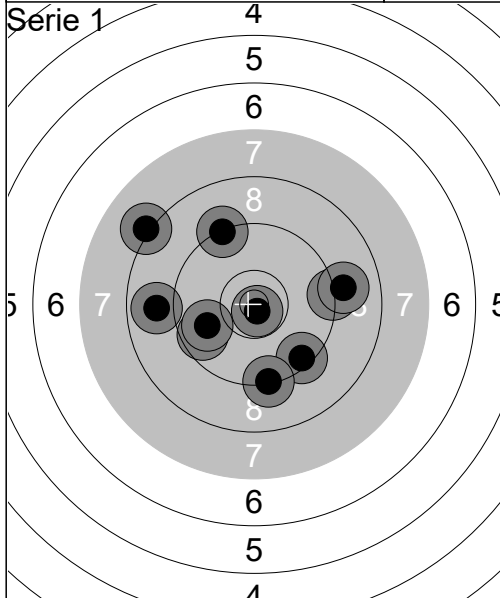

1:	9.3	→
2:	9.0	→
3:	9.7	↙
4:	9.8	↙
5:	8.9	←
6:	9.4	↘
7:	9.3	↗
8:	8.1	↗
9:	10.8x	↓
10:	9.3	↓
Serie		89 (1x)
Total		89 (1x)

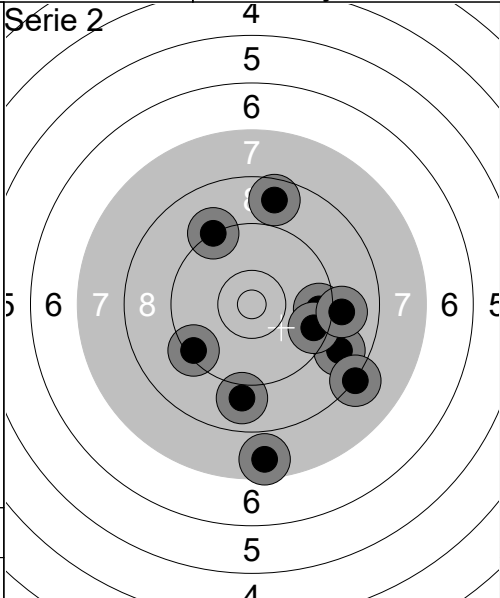

1:	8.8	↘
2:	9.5	→
3:	9.4	↙
4:	8.2	↘
5:	9.5	↗
6:	9.0	→
7:	8.9	↓
8:	7.6	↓
9:	9.2	↗
10:	8.7	↑
Serie		84 (0x)
Total		173 (1x)

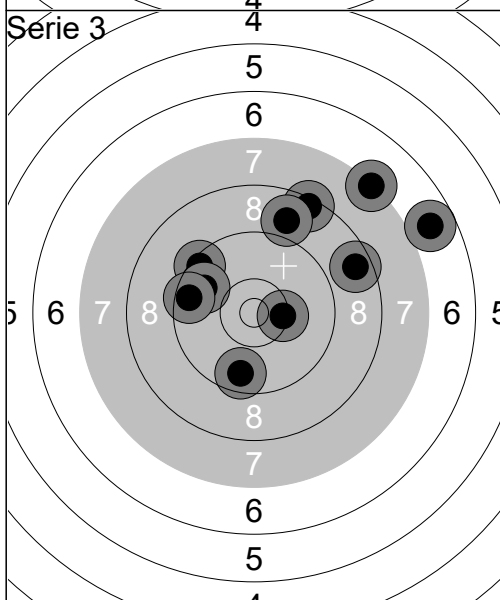

1:	8.4	↗
2:	9.4	↗
3:	10.3	→
4:	9.6	↓
5:	7.3	↗
6:	9.8	↙
7:	8.9	↗
8:	8.6	→
9:	9.5	←
10:	6.8	→
Serie		83 (0x)
Total		256 (1x)

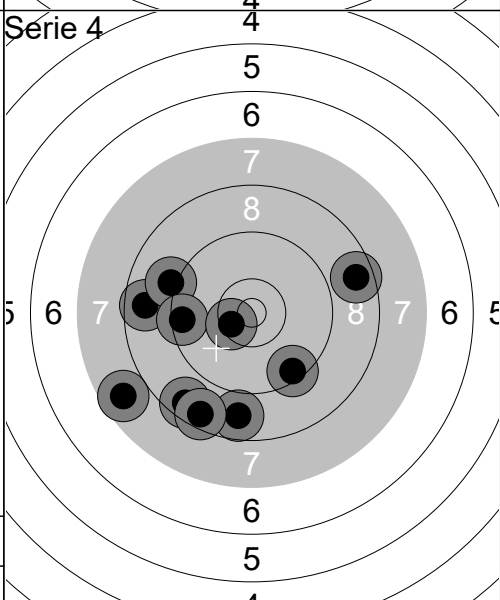

1:	9.4	↘
2:	8.7	←
3:	8.6	↘
4:	9.1	↙
5:	8.7	↓
6:	8.6	→
7:	8.5	↘
8:	9.5	←
9:	7.7	↙
10:	10.4x	↙
Serie		84 (1x)
Total		340 (2x)

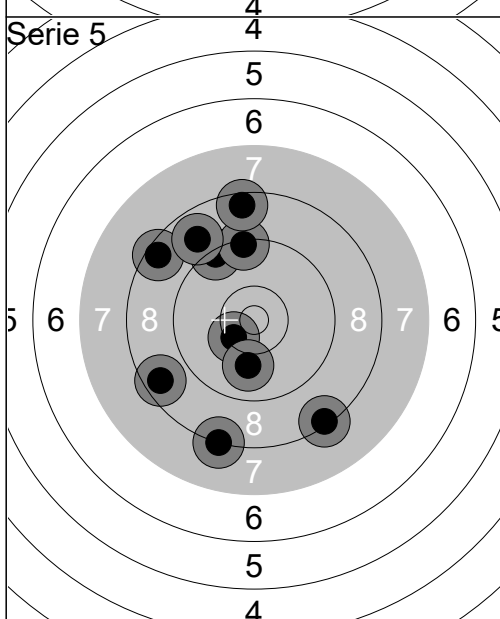

1:	8.3	↘
2:	9.3	↗
3:	8.2	↘
4:	10.4x	↙
5:	8.6	←
6:	8.5	↙
7:	10.0	↓
8:	9.3	↑
9:	8.9	↗
10:	8.5	↑
Serie		86 (1x)
Total		426 (3x)

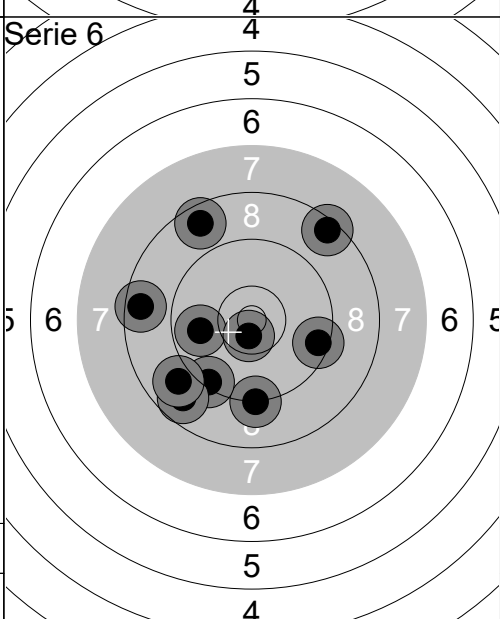

1:	9.5	↗
2:	9.2	↓
3:	9.3	↙
4:	8.4	↗
5:	8.6	↗
6:	8.6	←
7:	8.7	↙
8:	9.8	←
9:	10.6x	↓
10:	8.9	↙
Serie		86 (1x)
Total		512 (4x)

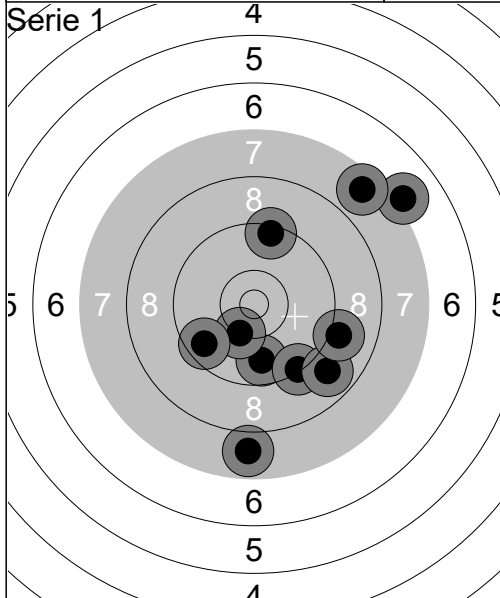

1:	7.0	↗
2:	9.4	↑
3:	9.7	↓
4:	10.3	↓
5:	7.6	↗
6:	9.3	↓
7:	8.8	↓
8:	9.0	→
9:	9.6	↙
10:	7.8	↓
Serie		84 (0x)
Total		84 (0x)

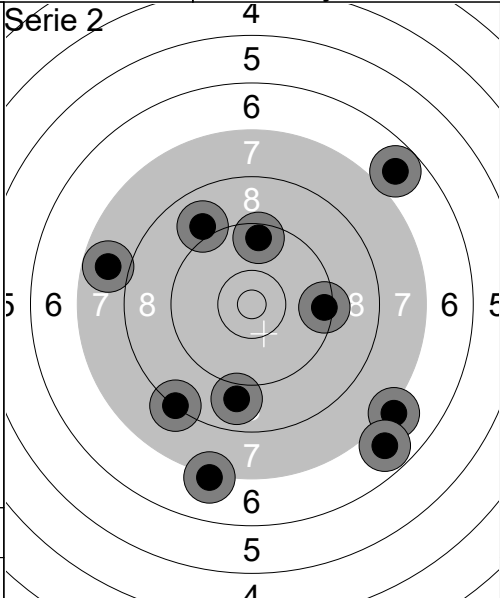

1:	9.0	↖
2:	6.8	↗
3:	9.5	↑
4:	7.8	←
5:	7.1	↓
6:	7.1	↘
7:	8.2	↙
8:	8.9	↓
9:	9.4	→
10:	6.8	↘
Serie		76 (0x)
Total		160 (0x)

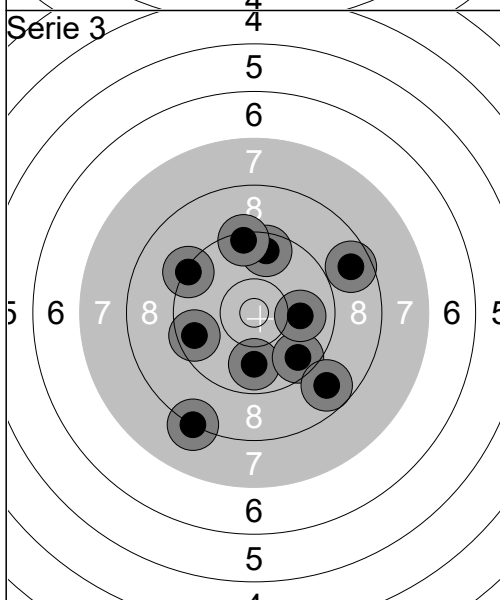

1:	9.8	↓
2:	9.6	←
3:	9.3	↖
4:	9.6	↘
5:	9.6	↑
6:	9.4	↑
7:	8.2	↙
8:	10.0	→
9:	8.8	↘
10:	8.7	↗
Serie		88 (0x)
Total		248 (0x)

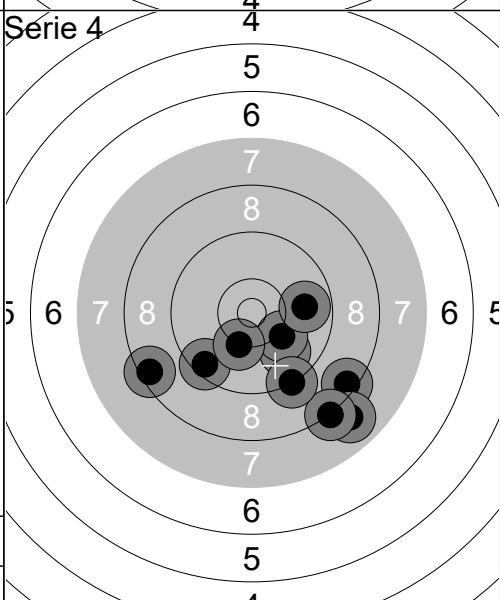

1:	9.5	↙
2:	9.9	↘
3:	10.1	↘
4:	9.8	→
5:	8.4	↘
6:	7.9	↘
7:	10.2	↙
8:	8.2	↘
9:	9.2	↘
10:	8.4	↙
Serie		87 (0x)
Total		335 (0x)

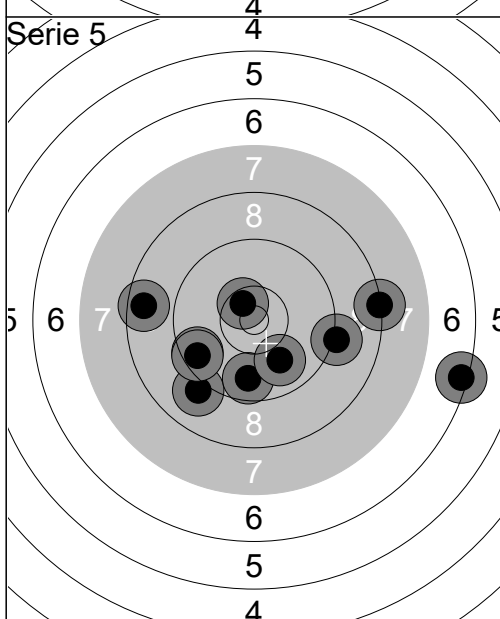

1:	9.0	↙
2:	9.6	←
3:	8.6	←
4:	9.7	↓
5:	9.1	→
6:	9.5	←
7:	10.5x	↗
8:	8.3	→
9:	9.9	↘
10:	6.4	→
Serie		86 (1x)
Total		421 (1x)

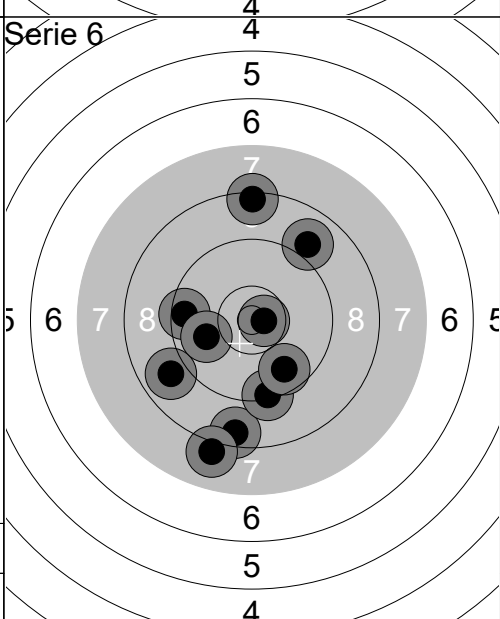

1:	8.5	↓
2:	9.5	←
3:	9.3	↓
4:	10.7x	→
5:	8.0	↓
6:	8.9	←
7:	8.4	↑
8:	9.0	↗
9:	9.9	←
10:	9.7	↘
Serie		87 (1x)
Total		508 (2x)

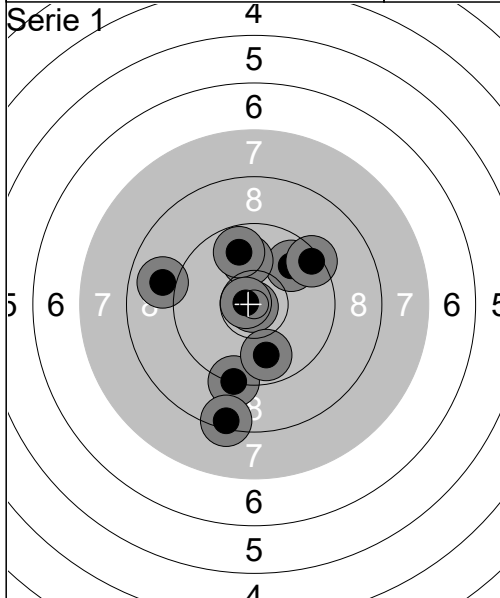

Série 2

1:	10.2	←
2:	9.2	↑
3:	9.7	↖
4:	8.3	↗
5:	10.2	↓
6:	9.0	↙
7:	8.9	↓
8:	9.1	↙
9:	9.5	↙
10:	8.8	↖
Série		89 (0x)
Total		180 (2x)

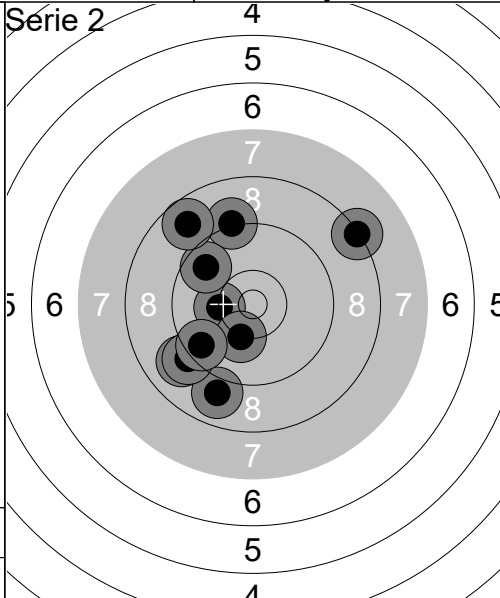

Série 4

1:	6.3	↗
2:	10.4x	↓
3:	9.5	⇒
4:	9.4	↓
5:	8.4	↑
6:	10.0	⇒
7:	10.3	↙
8:	9.3	↙
9:	9.4	↑
10:	9.9	↙
Série		89 (1x)
Total		356 (4x)

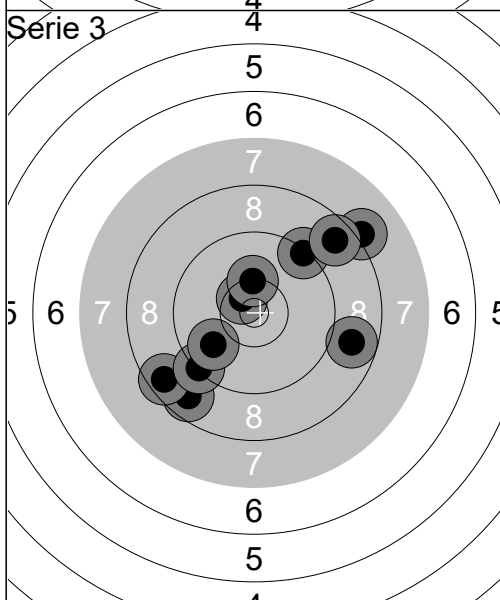

Série 6

1:	10.6x	←
2:	10.4x	↖
3:	8.7	↗
4:	10.0	↓
5:	10.0	⇒
6:	9.6	↓
7:	10.4x	↑
8:	10.0	↗
9:	10.7x	↑
10:	9.3	↓
Série		96 (4x)
Total		543 (9x)

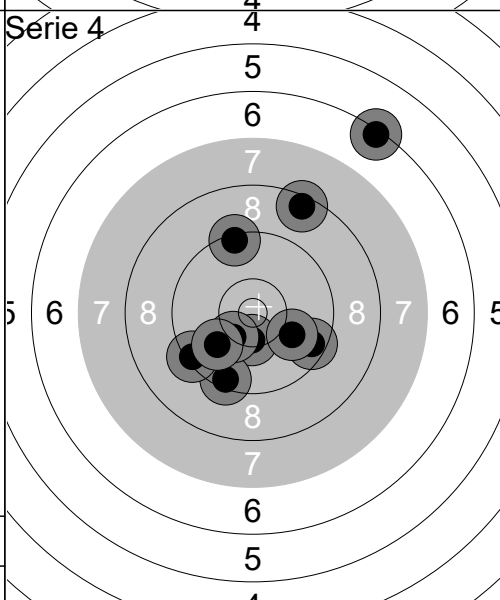
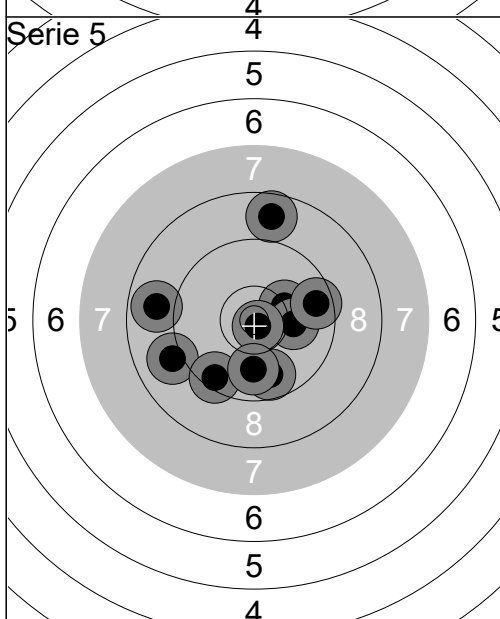
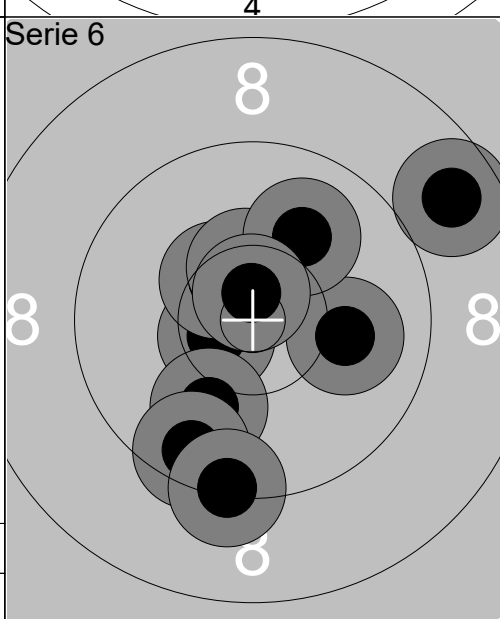

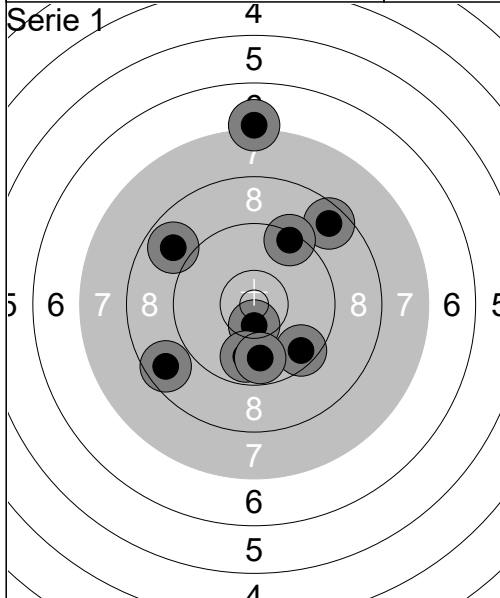
Série 2

1:	9.9	↗
2:	8.6	↓
3:	9.7	↘
4:	8.7	↓
5:	8.4	→
6:	10.3	↙
7:	8.8	↘
8:	9.1	↘
9:	9.6	←
10:	10.1	↙
Série		88 (0x)
Total		165 (1x)

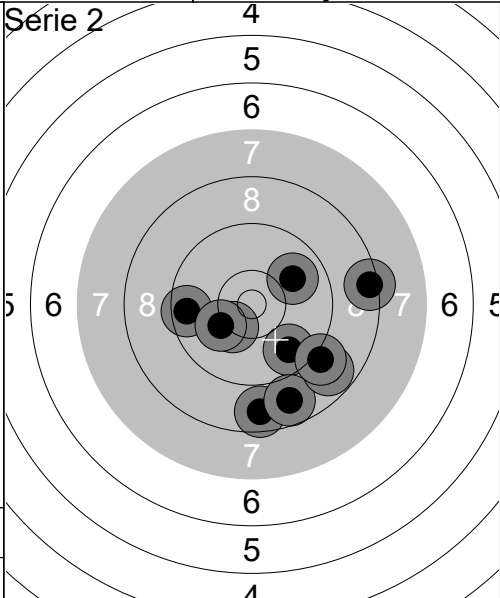

Série 4

1:	10.5x	↖
2:	10.2	↗
3:	9.7	↗
4:	8.2	↓
5:	9.9	→
6:	10.2	↖
7:	9.6	←
8:	8.4	↓
9:	10.7x	↖
10:	8.8	↙
Série		91 (2x)
Total		345 (4x)

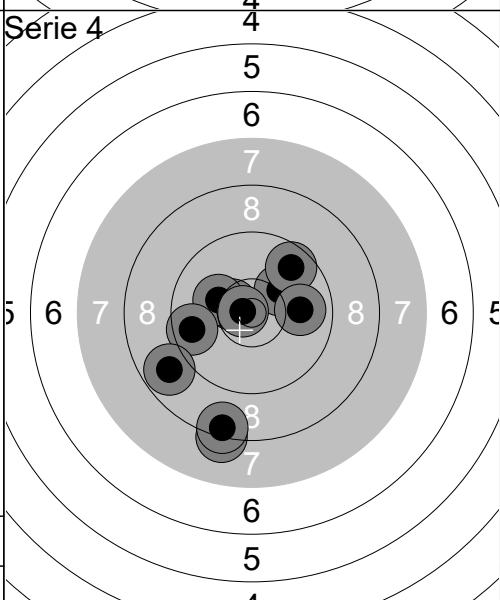

Série 6

1:	9.3	←
2:	8.3	↓
3:	9.4	↖
4:	8.7	↗
5:	8.2	←
6:	9.1	←
7:	10.6x	↑
8:	8.3	←
9:	9.5	↘
10:	9.7	↖
Série		87 (1x)
Total		521 (6x)

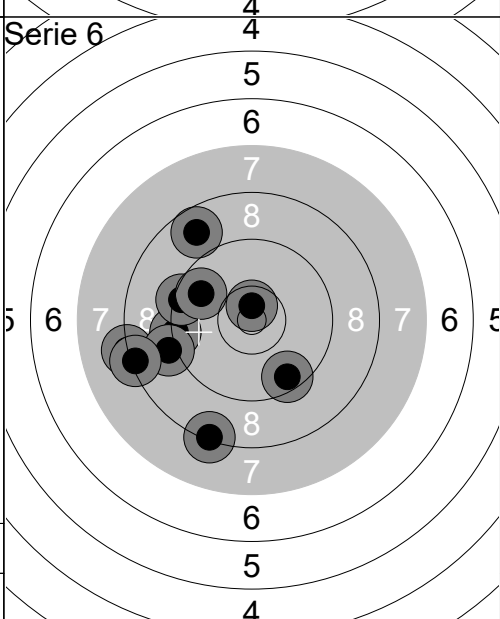

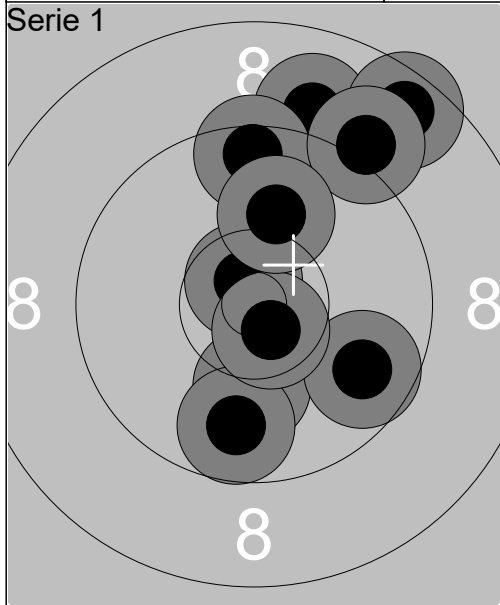

1:	9.0	↑
2:	8.6	↗
3:	10.2	↓
4:	9.5	↑
5:	9.1	↗
6:	10.7x	↗
7:	9.7	→
8:	9.8	↓
9:	10.6x	↓
10:	10.1	↑
Serie		93 (2x)
Total		93 (2x)

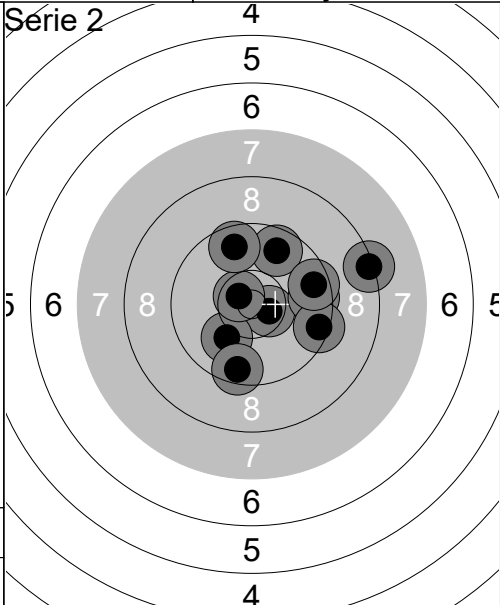

1:	10.6x	→
2:	9.6	→
3:	9.7	↑
4:	8.3	→
5:	10.0	↙
6:	10.6x	↖
7:	9.7	↑
8:	9.4	→
9:	9.6	→
10:	9.5	↓
Serie		92 (2x)
Total		185 (4x)

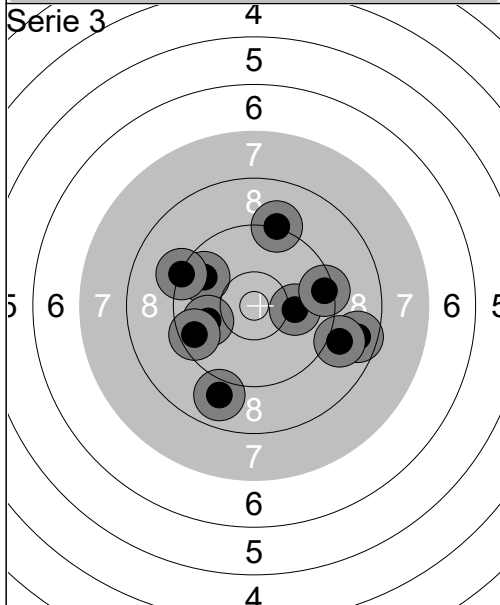

1:	8.9	↓
2:	9.7	↖
3:	10.1	→
4:	8.6	→
5:	9.9	←
6:	9.2	↑
7:	9.0	→
8:	9.4	→
9:	9.3	↖
10:	9.5	↖
Serie		89 (0x)
Total		274 (4x)

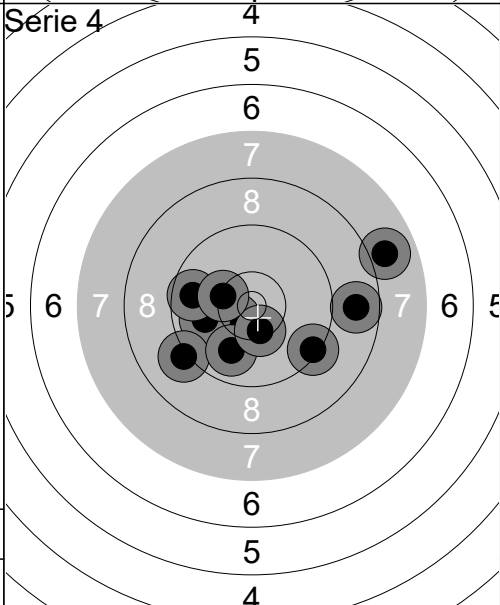

1:	10.5x	↙
2:	9.9	←
3:	9.1	↙
4:	9.9	↓
5:	7.9	→
6:	8.7	→
7:	9.7	←
8:	9.3	↘
9:	10.4x	↓
10:	10.3	←
Serie		90 (2x)
Total		364 (6x)

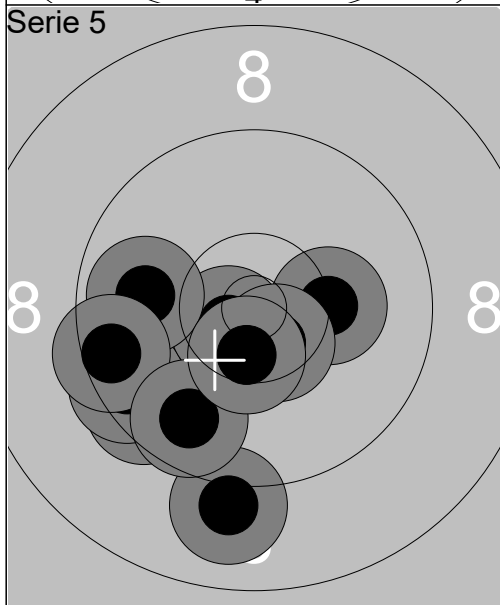

1:	9.5	↙
2:	9.5	↙
3:	10.6x	↙
4:	9.9	←
5:	9.0	↓
6:	9.5	←
7:	10.2	→
8:	9.7	↘
9:	10.5x	↘
10:	10.5x	↓
Serie		94 (3x)
Total		458 (9x)

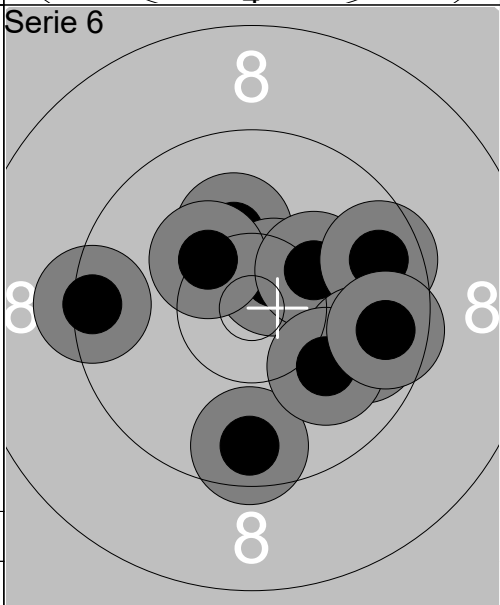

1:	9.4	←
2:	10.2	↑
3:	10.6x	↗
4:	10.3	↗
5:	10.2	↗
6:	9.6	→
7:	9.8	→
8:	9.6	↓
9:	10.0	↘
10:	9.6	→
Serie		95 (1x)
Total		553 (10x)

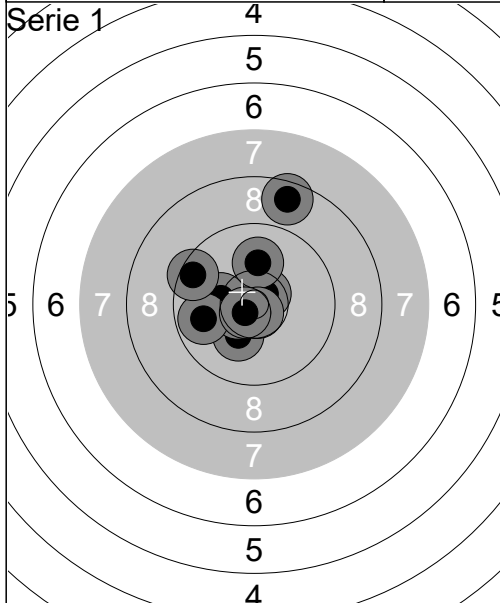

1:	10.6x ↗
2:	10.0 ↑
3:	10.2 ↓
4:	10.8x ↓
5:	10.5x ↙
6:	10.2 ←
7:	8.6 ↑
8:	9.8 ←
9:	10.7x ↙
10:	9.5 ↙
Serie	96 (4x)
Total	96 (4x)

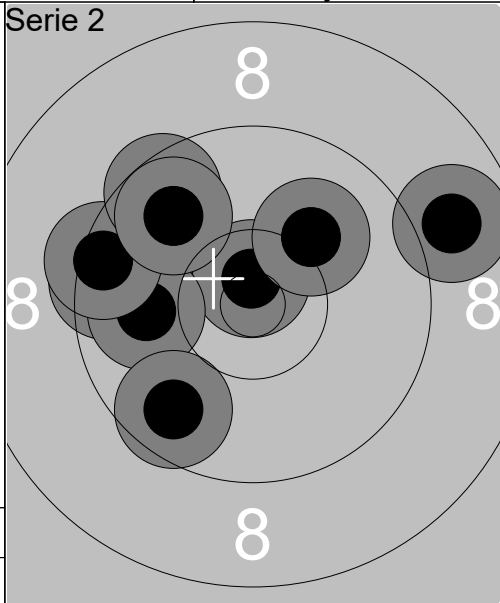

1:	9.7 ↙
2:	10.7x ↑
3:	9.5 ↙
4:	8.9 →
5:	9.9 ←
6:	9.7 ↙
7:	10.1 ↗
8:	9.4 ←
9:	9.6 ↗
10:	9.8 ↗
Serie	91 (1x)
Total	187 (5x)

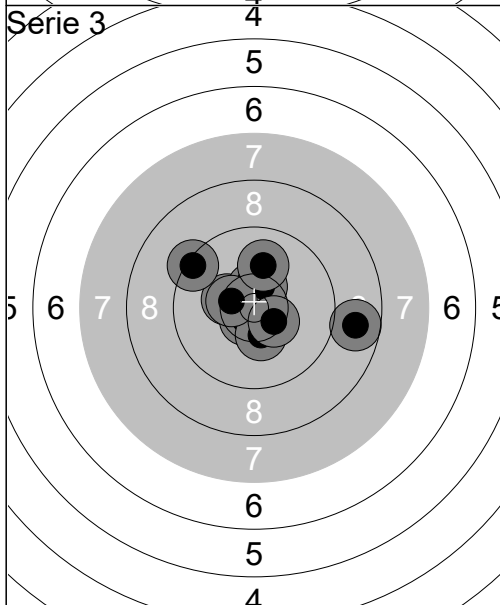

1:	10.3 ←
2:	10.5x ↑
3:	9.4 ↙
4:	10.5x ↑
5:	10.6x ↙
6:	10.4x ↓
7:	10.4x ↙
8:	10.4x ↘
9:	8.7 →
10:	10.0 ↑
Serie	97 (6x)
Total	284 (11x)

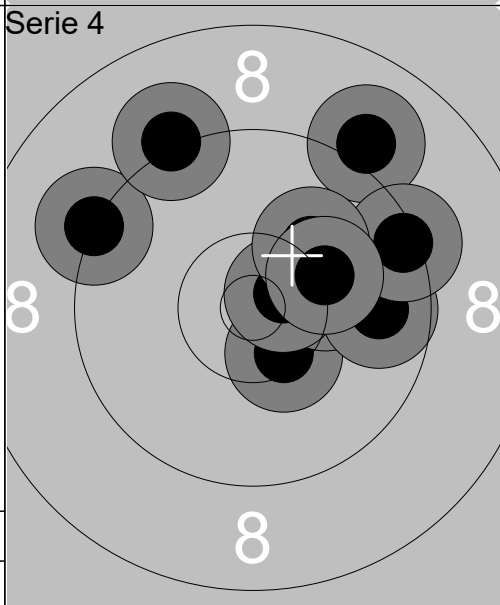

1:	10.4x ↘
2:	10.2 →
3:	9.7 →
4:	9.0 ↗
5:	10.6x →
6:	9.2 ↙
7:	9.4 →
8:	10.1 ↗
9:	9.2 ↗
10:	10.2 →
Serie	95 (2x)
Total	379 (13x)

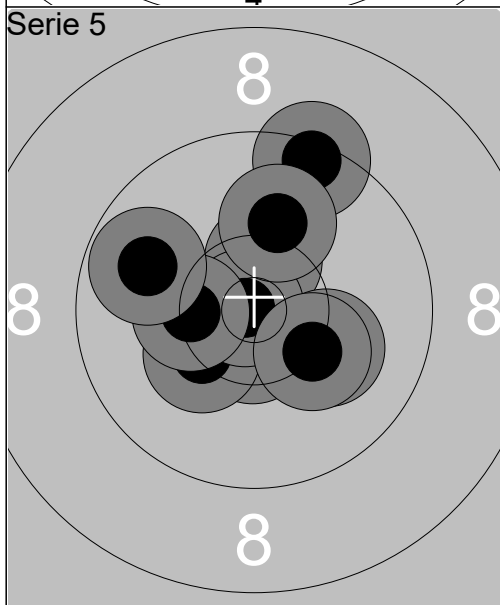

1:	10.6x ↓
2:	10.3 ↙
3:	10.5x ↑
4:	9.4 ↑
5:	10.8x ↙
6:	10.2 →
7:	10.3 ↘
8:	10.3 ←
9:	9.8 ↙
10:	10.1 ↑
Serie	98 (3x)
Total	477 (16x)

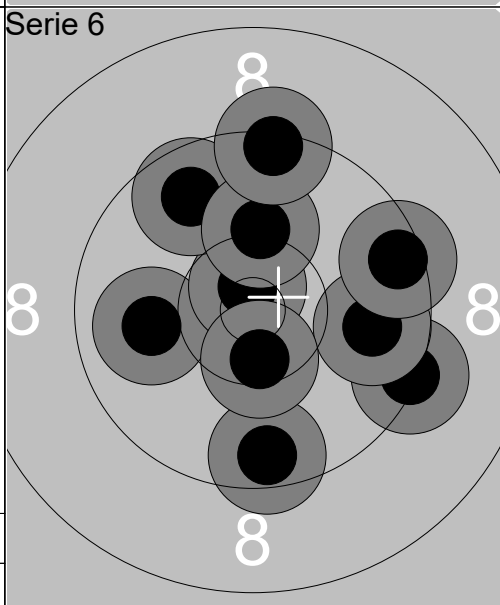

1:	10.0 ←
2:	9.3 →
3:	10.7x ↑
4:	9.5 ↓
5:	9.8 →
6:	9.7 ↗
7:	10.2 ↑
8:	9.5 →
9:	10.5x ↓
10:	9.4 ↑
Serie	94 (2x)
Total	571 (18x)

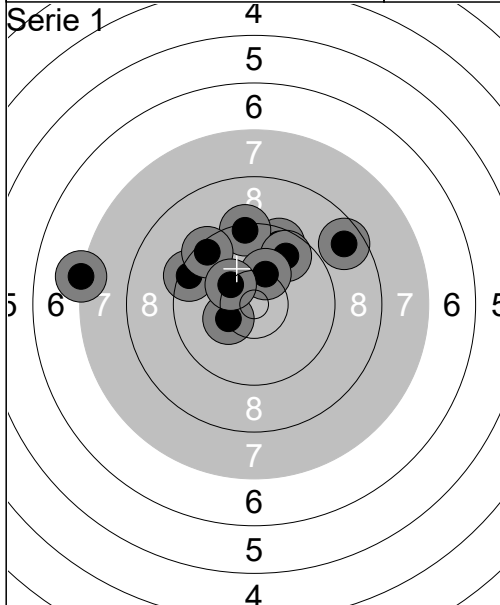

Serie 2

1:	9.3	↗
2:	10.6x	↑
3:	9.2	↓
4:	9.7	⇒
5:	9.7	↖
6:	10.6x	↖
7:	9.3	⇒
8:	10.7x	↘
9:	10.7x	↘
10:	9.7	←
Serie		94 (4x)
Total		184 (4x)

Serie 3

1:	8.9	↖
2:	9.0	⇒
3:	10.2	↗
4:	10.7x	↘
5:	9.3	↗
6:	9.5	←
7:	9.7	↓
8:	9.1	↖
9:	10.1	↘
10:	9.9	↗
Serie		92 (1x)
Total		276 (5x)

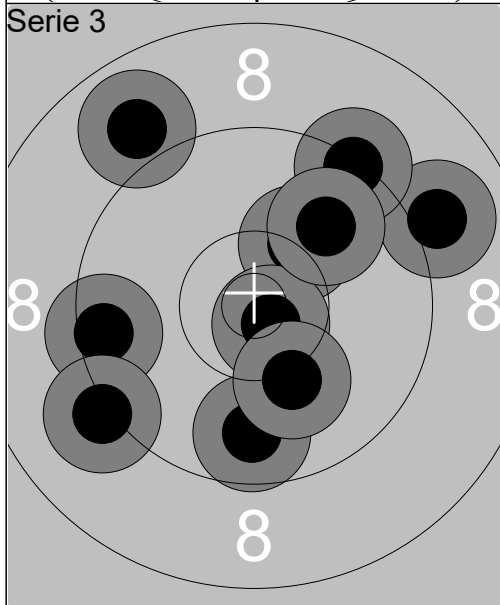

Serie 5

1:	10.8x	↘
2:	10.2	↘
3:	8.4	↖
4:	9.8	←
5:	10.4x	⇒
6:	9.3	↗
7:	9.4	↘
8:	9.9	↘
9:	10.8x	↖
10:	9.7	↗
Serie		93 (3x)
Total		459 (11x)

Serie 6

1:	9.6	↖
2:	8.9	↘
3:	9.2	↗
4:	9.8	↗
5:	10.2	⇒
6:	10.1	←
7:	9.7	↑
8:	9.9	↖
9:	10.2	↘
10:	10.1	↖
Serie		93 (0x)
Total		552 (11x)

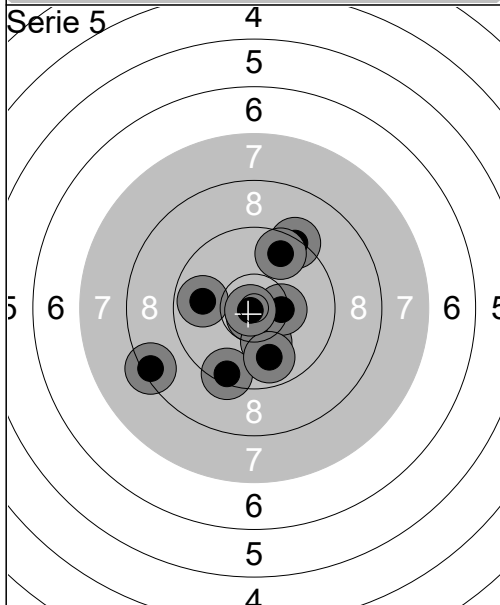

Serie 6

1:	9.6	↖
2:	8.9	↘
3:	9.2	↗
4:	9.8	↗
5:	10.2	⇒
6:	10.1	←
7:	9.7	↑
8:	9.9	↖
9:	10.2	↘
10:	10.1	↖
Serie		93 (0x)
Total		552 (11x)

Serie 6

1:	9.6	↖
2:	8.9	↘
3:	9.2	↗
4:	9.8	↗
5:	10.2	⇒
6:	10.1	←
7:	9.7	↑
8:	9.9	↖
9:	10.2	↘
10:	10.1	↖
Serie		93 (0x)
Total		552 (11x)

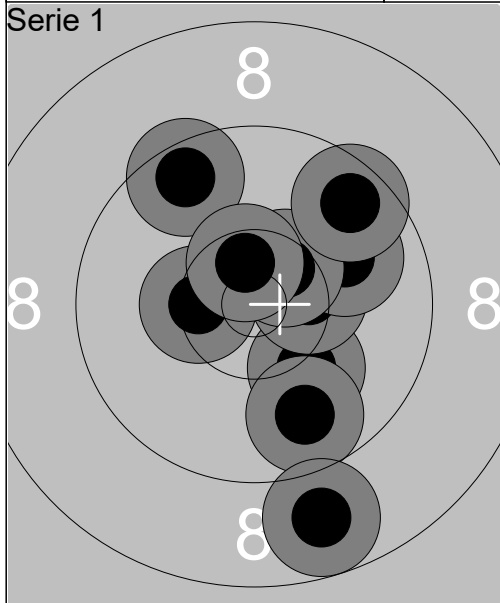

1:	10.4x	←
2:	10.2	↘
3:	10.4x	→
4:	9.8	↘
5:	10.0	↗
6:	10.5x	↗
7:	9.5	↖
8:	8.8	↘
9:	9.6	↗
10:	10.5x	↑
Serie		95 (4x)
Total		95 (4x)

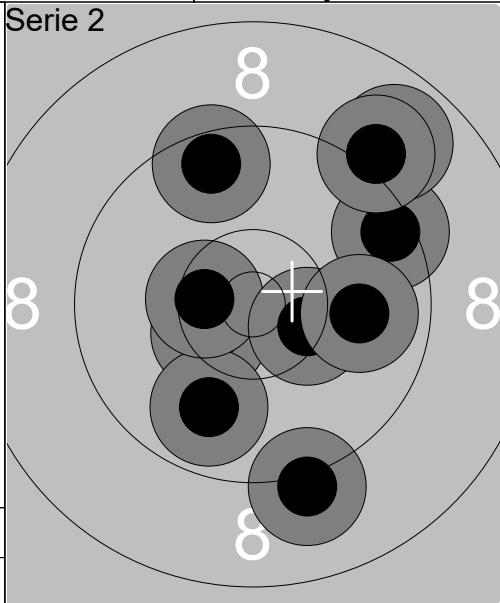

1:	10.4x	↙
2:	9.1	↘
3:	9.4	↗
4:	9.9	↘
5:	9.5	↑
6:	10.5x	←
7:	10.4x	→
8:	8.9	↗
9:	9.9	→
10:	9.1	↗
Serie		92 (3x)
Total		187 (7x)

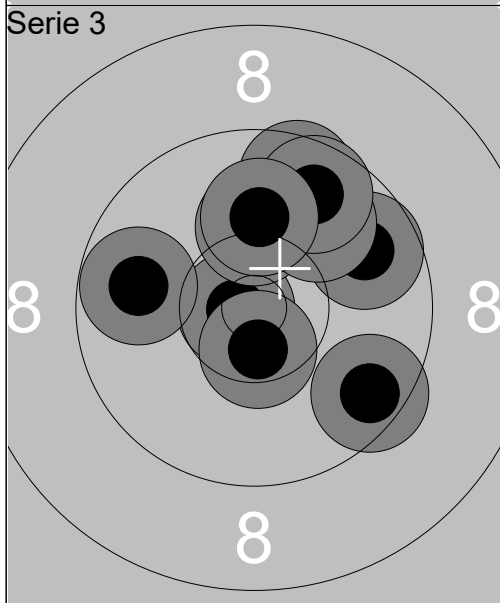

1:	10.8x	←
2:	9.7	↗
3:	10.2	↑
4:	9.6	↘
5:	9.9	↗
6:	9.6	↑
7:	9.7	↗
8:	10.5x	↘
9:	9.8	←
10:	10.1	↑
Serie		94 (2x)
Total		281 (9x)

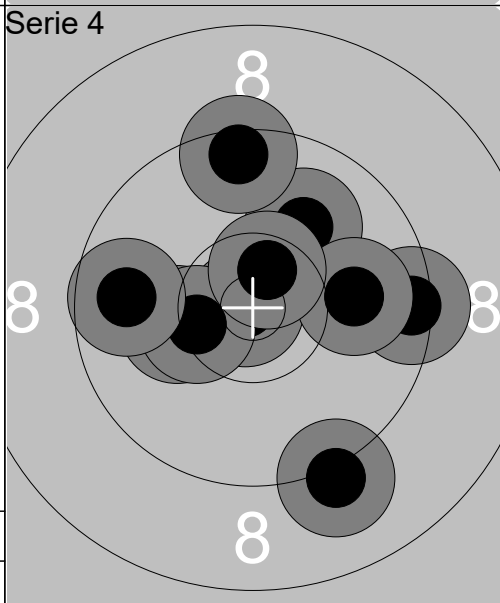

1:	9.4	→
2:	9.1	↘
3:	10.2	←
4:	10.9x	←
5:	10.4x	←
6:	10.0	↗
7:	9.7	←
8:	10.0	→
9:	10.6x	↗
10:	9.5	↑
Serie		96 (3x)
Total		377 (12x)

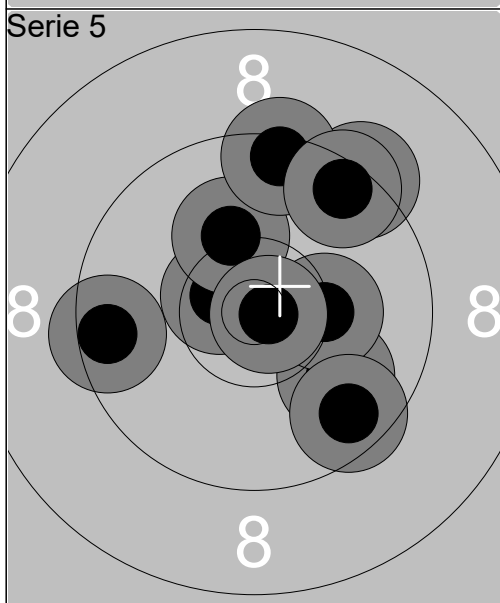

1:	9.9	↘
2:	9.5	←
3:	10.6x	↖
4:	9.3	↗
5:	10.2	↑
6:	10.3	→
7:	9.4	↑
8:	9.5	↗
9:	9.6	↘
10:	10.8x	→
Serie		94 (2x)
Total		471 (14x)

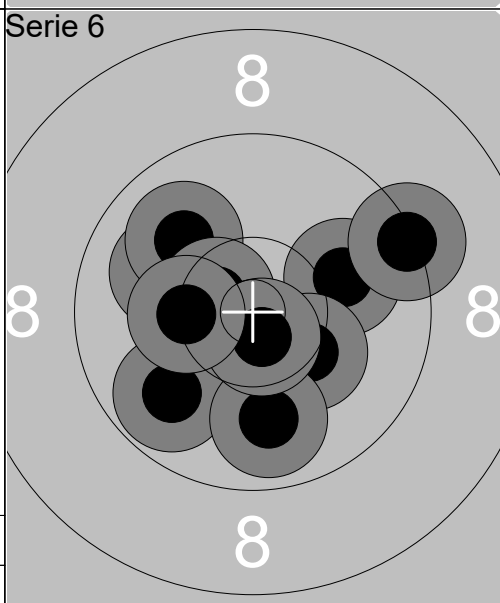

1:	9.8	↙
2:	10.0	↗
3:	9.3	↗
4:	10.0	↖
5:	10.3	↘
6:	10.0	↗
7:	9.9	↘
8:	10.6x	↖
9:	10.7x	↘
10:	10.3	←
Serie		97 (2x)
Total		568 (16x)

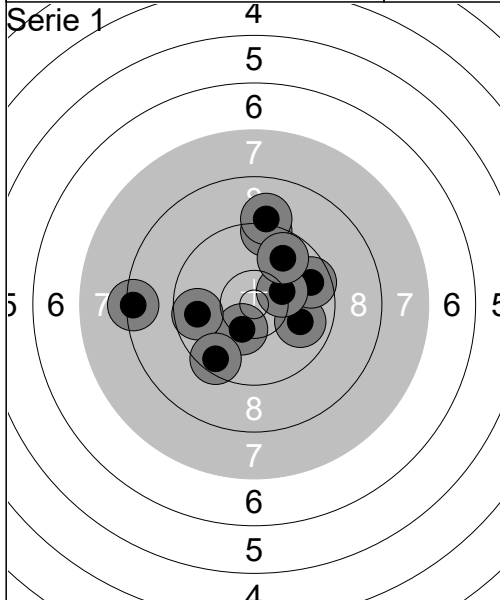

Série 2

1:	9.1	←
2:	9.1	↓
3:	6.9	↙
4:	9.9	←
5:	9.5	↓
6:	9.0	↓
7:	10.6x	↑
8:	9.2	←
9:	7.7	↙
10:	9.8	→
Série		86 (1x)
Total		177 (1x)

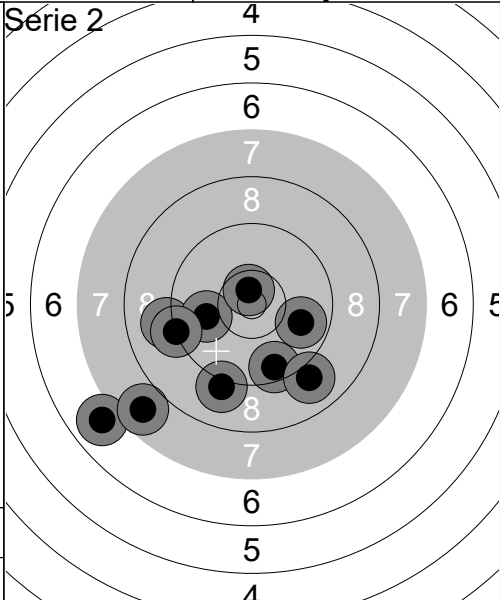

Série 4

1:	8.5	↙
2:	10.0	←
3:	9.2	↙
4:	10.1	↙
5:	10.4x	↓
6:	9.4	↙
7:	8.8	↙
8:	10.6x	↑
9:	8.6	↓
10:	9.4	↙
Série		91 (2x)
Total		353 (3x)

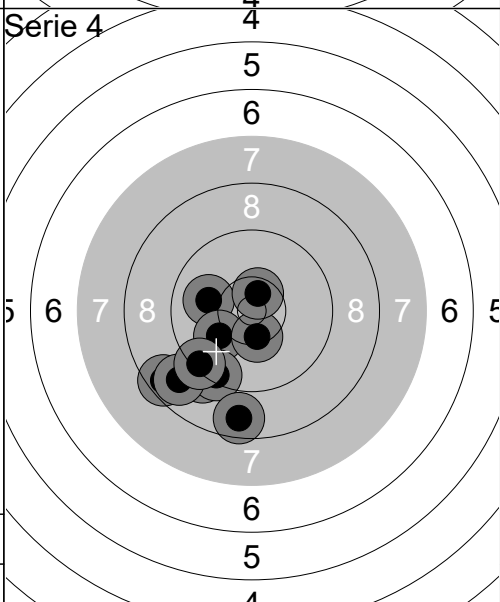

Série 6

1:	9.9	↗
2:	8.8	←
3:	9.8	↘
4:	8.0	←
5:	8.1	↓
6:	8.6	↗
7:	10.3	↓
8:	8.8	↘
9:	8.5	↙
10:	9.7	↗
Série		85 (0x)
Total		518 (4x)

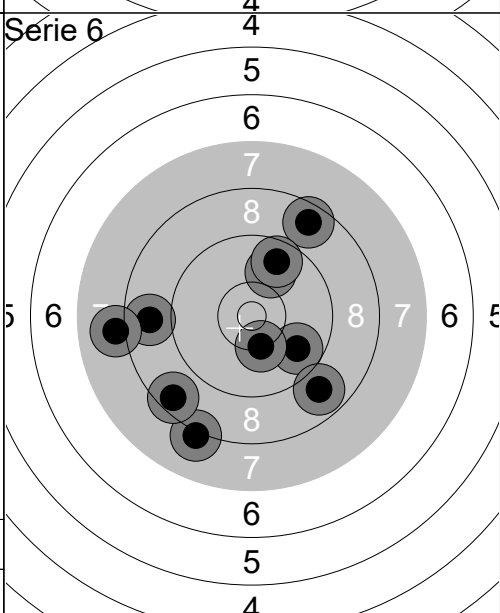

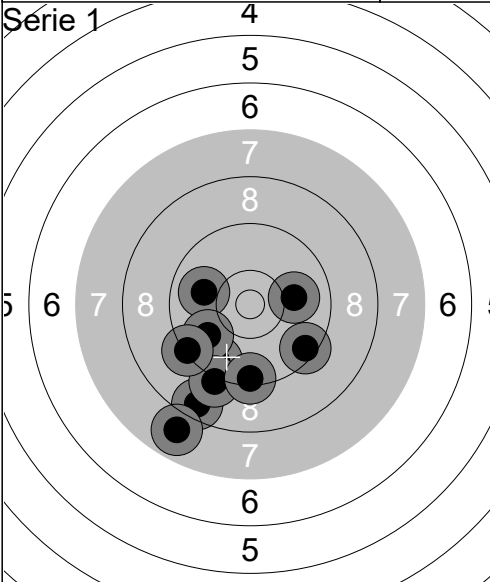
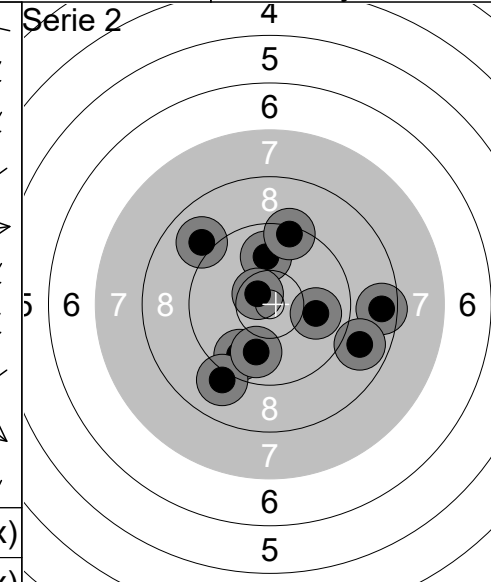
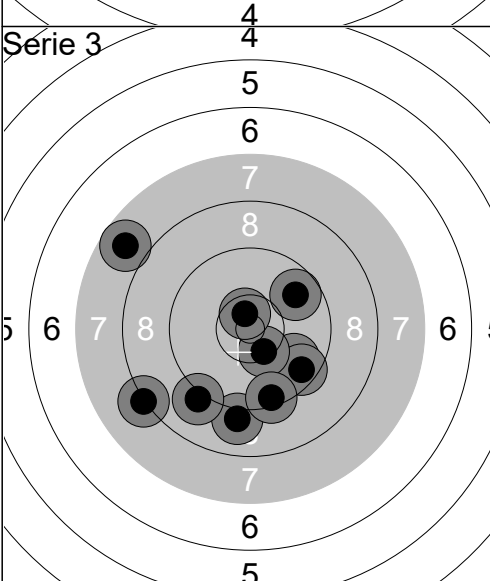
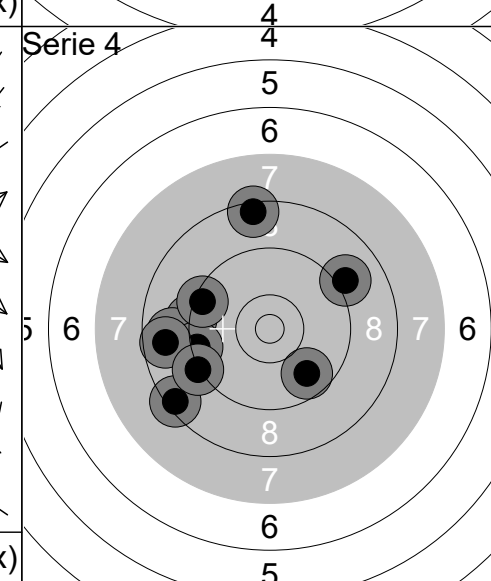
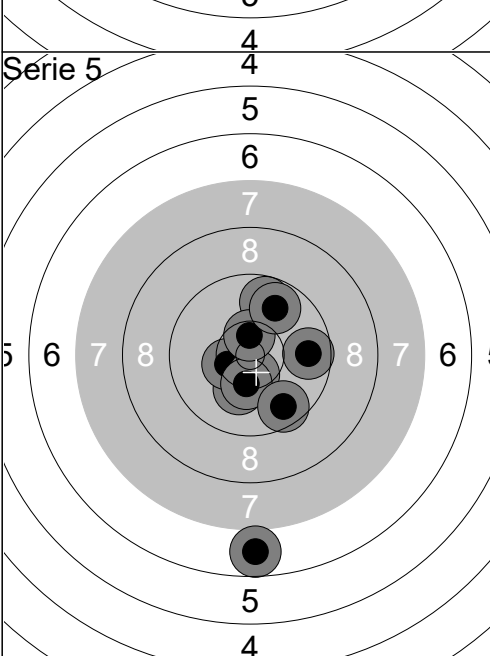
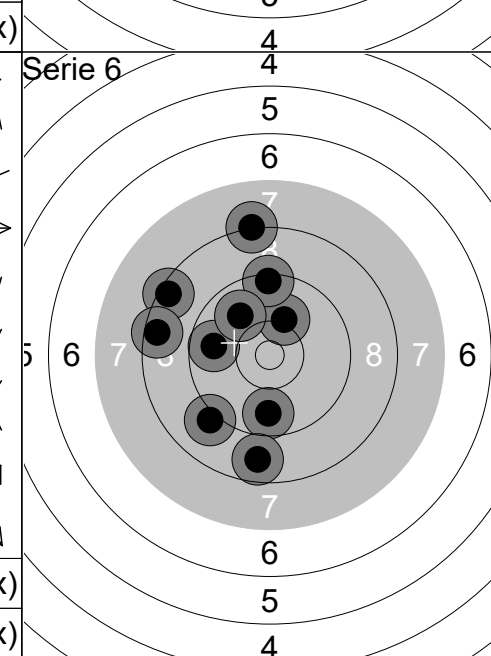
<p>Série 1</p> 	<p>1: 9.9 ← 2: 8.5 ↙ 3: 9.5 ↙ 4: 9.8 ← 5: 10.0 → 6: 7.9 ↙ 7: 9.1 ↙ 8: 9.3 ← 9: 9.4 → 10: 9.4 ↓</p> <p>Série 88 (0x) Total 88 (0x)</p>	<p>Série 2</p> 	<p>1: 8.6 → 2: 9.7 ↙ 3: 9.0 ↗ 4: 9.9 ↑ 5: 9.0 ↙ 6: 9.9 → 7: 8.9 → 8: 10.6x ↗ 9: 9.9 ↓ 10: 9.4 ↑</p> <p>Série 89 (1x) Total 177 (1x)</p>
<p>Série 3</p> 	<p>1: 9.0 ↓ 2: 9.1 ↙ 3: 8.2 ← 4: 9.7 ↗ 5: 9.8 → 6: 9.5 → 7: 10.4x ↙ 8: 9.4 ↓ 9: 10.6x ↑ 10: 7.8 ↖</p> <p>Série 89 (2x) Total 266 (3x)</p>	<p>Série 4</p> 	<p>1: 9.3 ← 2: 8.4 ↑ 3: 8.9 ← 4: 9.4 ← 5: 9.7 ↙ 6: 8.4 ← 7: 9.0 ↗ 8: 8.7 ← 9: 9.4 ← 10: 9.2 ↙</p> <p>Série 86 (0x) Total 352 (3x)</p>
<p>Série 5</p> 	<p>1: 10.2 ↓ 2: 9.8 ↑ 3: 10.4x ← 4: 9.7 → 5: 10.5x ↓ 6: 6.8 ↓ 7: 10.3 ↓ 8: 10.5x ↑ 9: 9.8 ↗ 10: 9.6 ↓</p> <p>Série 92 (3x) Total 444 (6x)</p>	<p>Série 6</p> 	<p>1: 10.1 ↑ 2: 9.7 ↓ 3: 9.1 ↙ 4: 8.7 ↓ 5: 8.4 ↖ 6: 8.2 ↑ 7: 9.7 ← 8: 8.5 ← 9: 9.4 ↑ 10: 9.9 ↗</p> <p>Série 87 (0x) Total 531 (6x)</p>

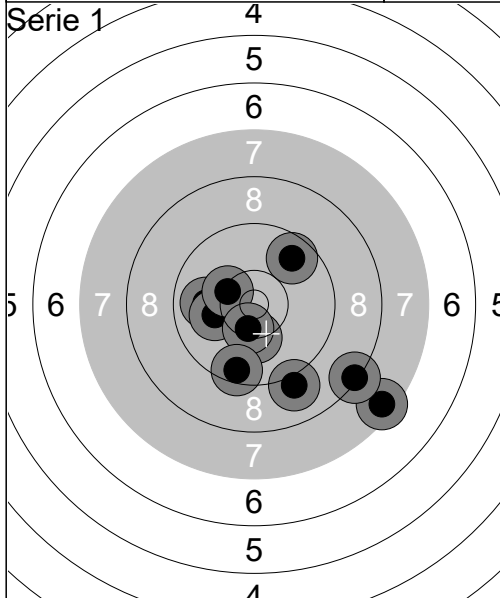

1:	9.0	↘
2:	9.9	←
3:	7.5	↘
4:	10.2	↓
5:	10.1	←
6:	8.3	↘
7:	10.3	↖
8:	9.7	↗
9:	10.4x	↓
10:	9.5	↓
Serie		91 (1x)
Total		91 (1x)

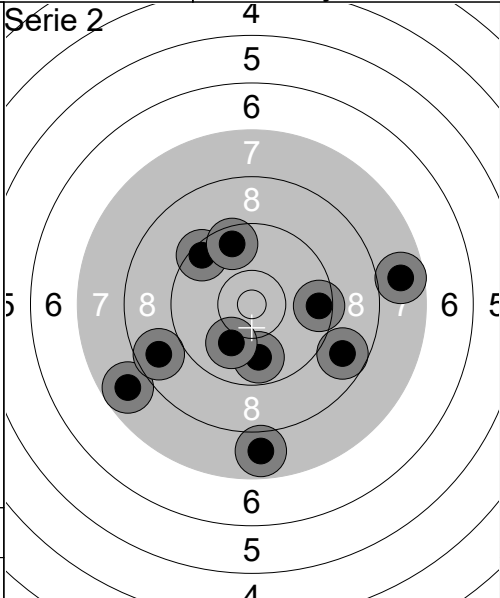

1:	9.8	↓
2:	9.5	↗
3:	7.8	↙
4:	8.7	↙
5:	7.8	↓
6:	8.7	↘
7:	7.7	→
8:	9.6	↑
9:	9.5	→
10:	10.0	↓
Serie		83 (0x)
Total		174 (1x)

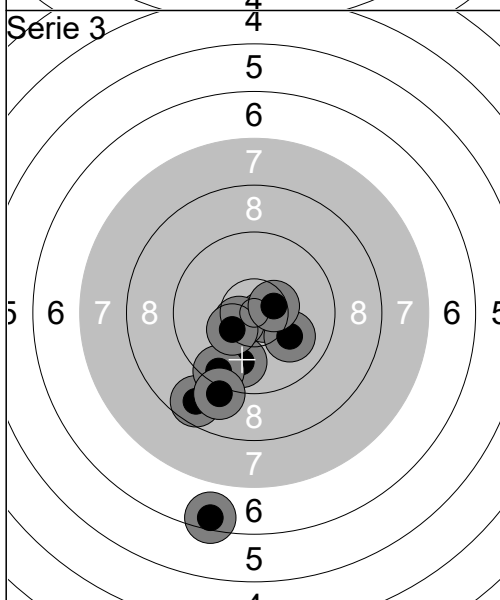

1:	8.7	↘
2:	10.7x	→
3:	9.9	↓
4:	9.5	↓
5:	10.6x	↙
6:	6.5	↓
7:	10.4x	↙
8:	9.1	↓
9:	10.0	↘
10:	10.5x	→
Serie		91 (4x)
Total		265 (5x)

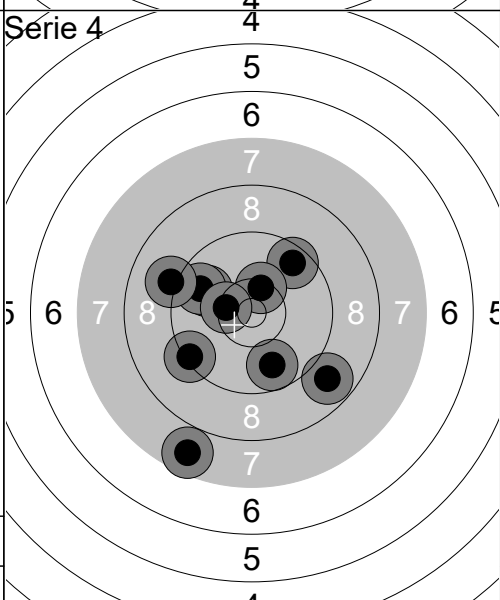

1:	9.9	↖
2:	8.8	↘
3:	9.7	↖
4:	9.6	↗
5:	10.4x	↑
6:	9.1	↖
7:	7.7	↓
8:	9.7	↓
9:	10.4x	↙
10:	9.3	↙
Serie		89 (2x)
Total		354 (7x)

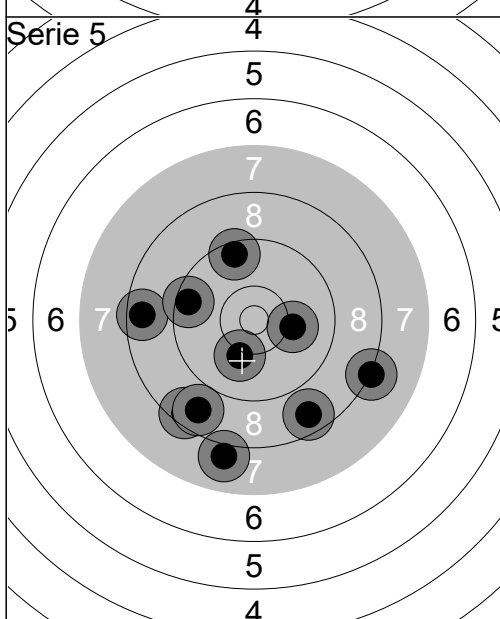

1:	8.5	↘
2:	8.6	←
3:	8.6	↘
4:	10.1	→
5:	9.5	←
6:	10.1	↓
7:	9.5	↑
8:	8.2	↘
9:	8.0	↓
10:	8.7	↘
Serie		86 (0x)
Total		440 (7x)

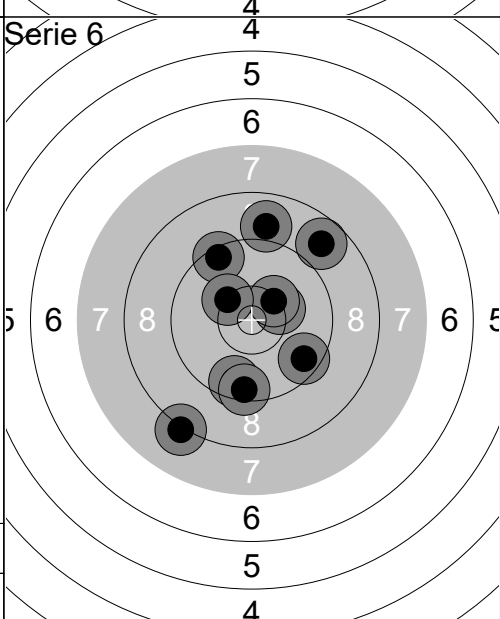

1:	9.4	↗
2:	8.9	↑
3:	10.3	→
4:	9.6	↘
5:	8.8	↗
6:	9.6	↓
7:	10.3	↗
8:	9.5	↓
9:	8.2	↘
10:	10.3	↖
Serie		90 (0x)
Total		530 (7x)

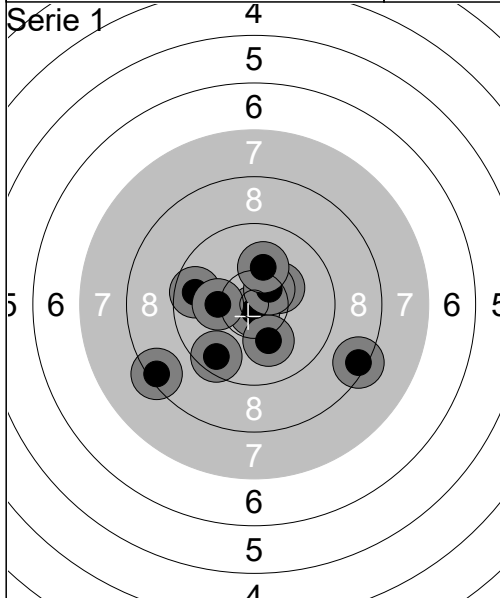

1:	8.4	↙
2:	8.4	→
3:	10.8x	↓
4:	10.3	↗
5:	9.6	↙
6:	9.7	←
7:	10.2	←
8:	10.1	↓
9:	10.5x	↗
10:	10.1	↑
Série		94 (2x)
Total		94 (2x)

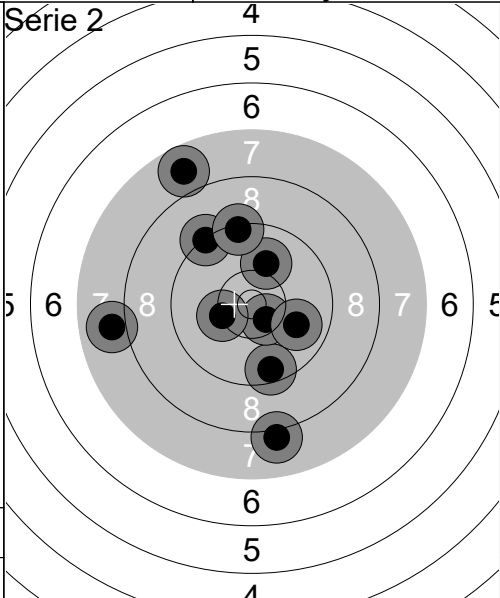

1:	9.5	↓
2:	7.9	←
3:	10.0	↑
4:	10.5x	↘
5:	9.3	↗
6:	10.3	←
7:	8.1	↓
8:	9.9	→
9:	7.8	↗
10:	9.3	↑
Série		88 (1x)
Total		182 (3x)

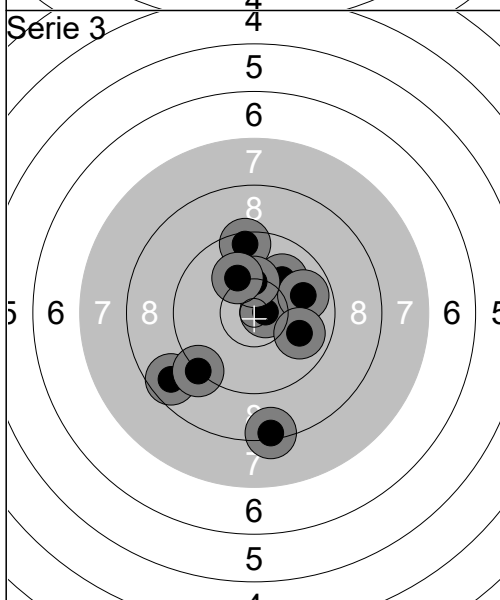

1:	10.0	↗
2:	10.7x	→
3:	8.4	↓
4:	9.8	→
5:	8.7	↙
6:	9.2	↙
7:	9.5	↑
8:	10.3	↑
9:	9.9	→
10:	10.1	↗
Série		92 (1x)
Total		274 (4x)

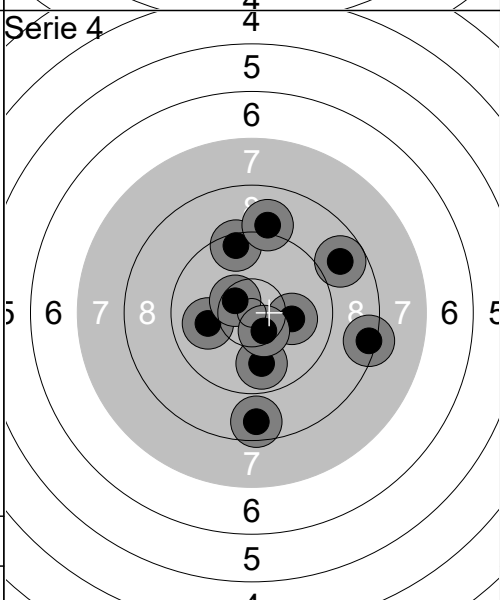

1:	10.0	←
2:	8.4	→
3:	10.1	→
4:	9.9	↓
5:	10.5x	↖
6:	9.5	↑
7:	10.5x	↘
8:	8.8	↗
9:	9.1	↑
10:	8.6	↓
Série		91 (2x)
Total		365 (6x)

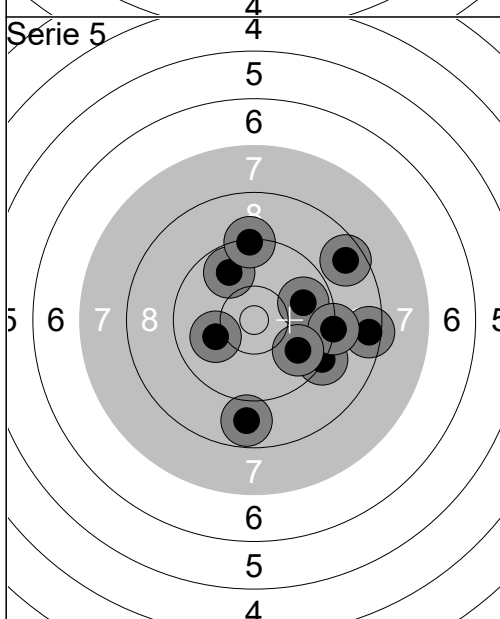

1:	8.5	→
2:	9.8	↗
3:	9.8	→
4:	8.6	↗
5:	8.8	↓
6:	9.3	↘
7:	9.3	↑
8:	9.2	→
9:	9.8	↘
10:	10.1	←
Série		88 (0x)
Total		453 (6x)

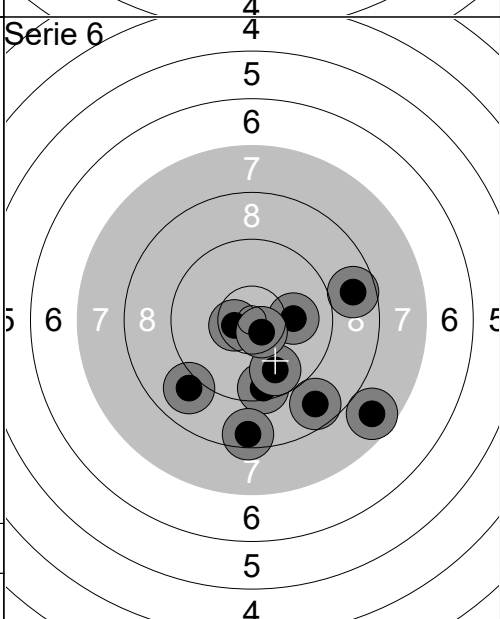

1:	9.5	↓
2:	8.7	→
3:	9.8	↓
4:	10.5x	←
5:	10.1	→
6:	9.0	↙
7:	8.7	↘
8:	7.7	↘
9:	8.5	↓
10:	10.6x	↘
Série		88 (2x)
Total		541 (8x)

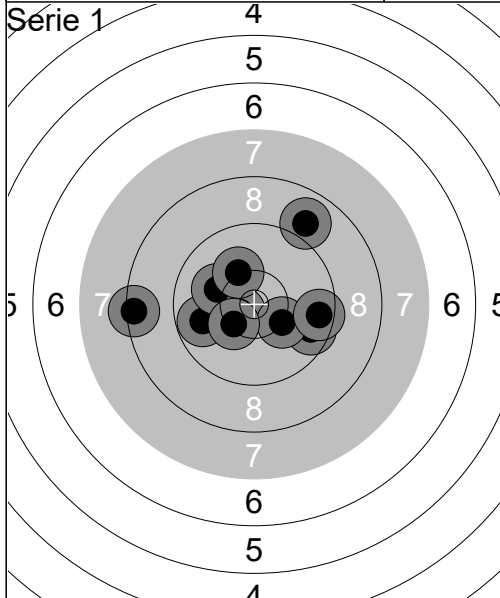

1:	9.8	←
2:	10.6x	↙
3:	9.6	→
4:	8.9	↗
5:	10.1	←
6:	8.4	←
7:	10.2	↘
8:	10.2	↗
9:	9.5	→
10:	10.3	↙
Serie		93 (1x)
Total		93 (1x)

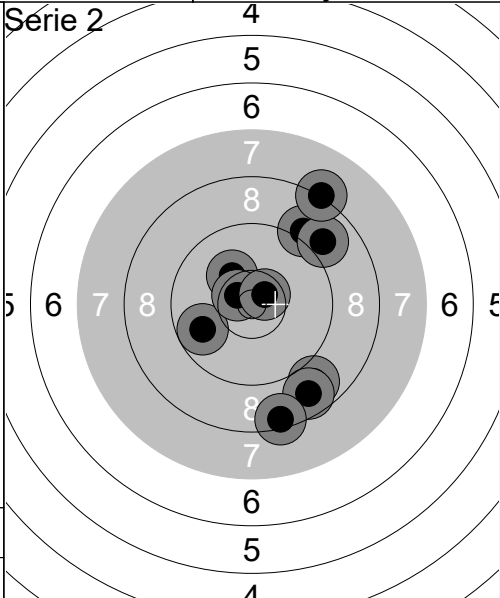

1:	9.8	↙
2:	8.8	↘
3:	10.2	↗
4:	10.6x	↙
5:	9.0	↗
6:	8.9	↗
7:	10.6x	↗
8:	8.7	↘
9:	8.4	↘
10:	8.2	↗
Serie		88 (2x)
Total		181 (3x)

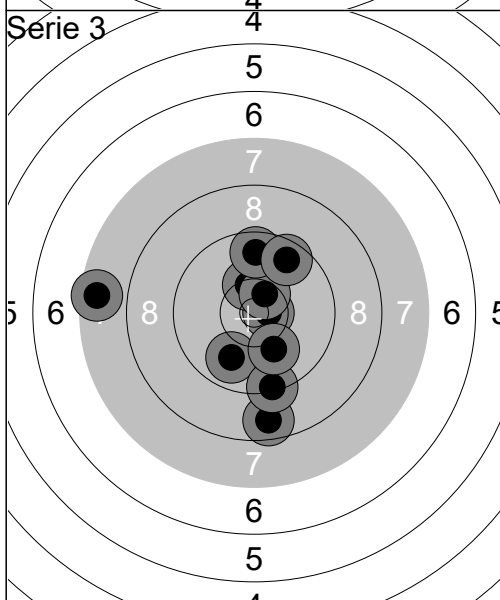

1:	10.6x	→
2:	10.3	↑
3:	7.6	←
4:	10.5x	↗
5:	9.9	↘
6:	8.6	↘
7:	9.7	↑
8:	9.6	↗
9:	9.3	↘
10:	10.1	↘
Serie		91 (2x)
Total		272 (5x)

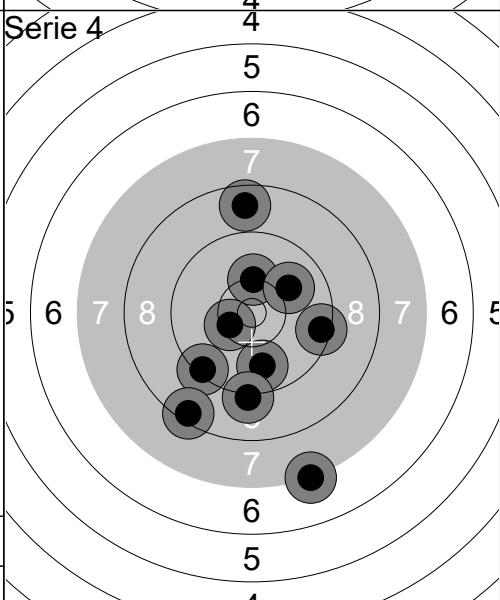

1:	8.6	↑
2:	10.2	↑
3:	9.8	↘
4:	9.4	↙
5:	8.4	↙
6:	10.0	↗
7:	9.1	↘
8:	10.4x	↙
9:	7.2	↘
10:	9.4	→
Serie		89 (1x)
Total		361 (6x)

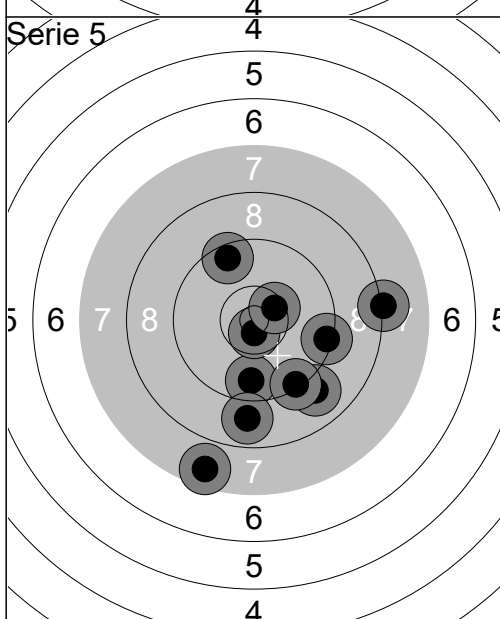

1:	9.7	↘
2:	9.0	↘
3:	10.7x	↘
4:	9.3	→
5:	9.3	↘
6:	8.2	→
7:	7.6	↘
8:	9.5	↗
9:	10.4x	↗
10:	8.9	↘
Serie		88 (2x)
Total		449 (8x)

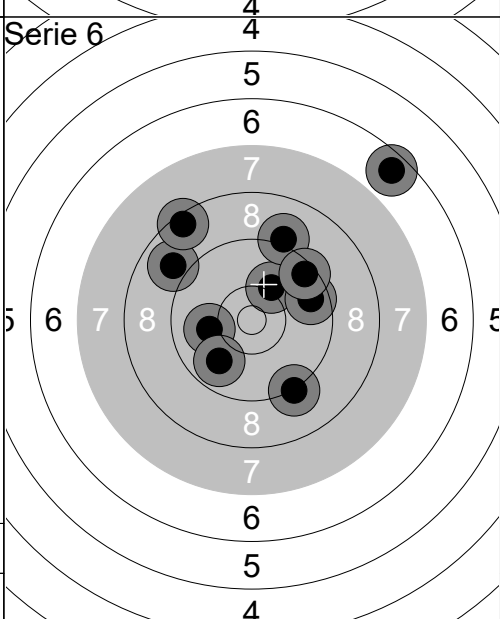

1:	10.1	↗
2:	10.0	←
3:	9.1	↑
4:	9.6	→
5:	8.9	↙
6:	9.8	↙
7:	9.4	↗
8:	6.6	↗
9:	8.4	↗
10:	9.2	↘
Serie		87 (0x)
Total		536 (8x)

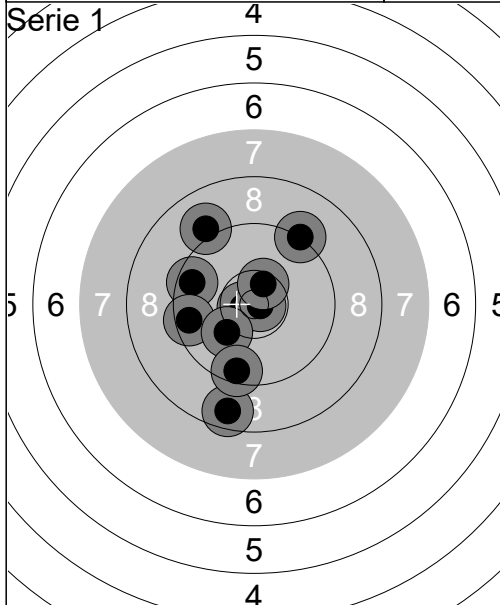

1:	10.7x	←
2:	10.8x	→
3:	9.5	←
4:	9.2	↗
5:	10.5x	↗
6:	9.5	←
7:	9.0	↖
8:	10.1	↙
9:	8.6	↓
10:	9.5	↓
Serie		93 (3x)
Total		93 (3x)

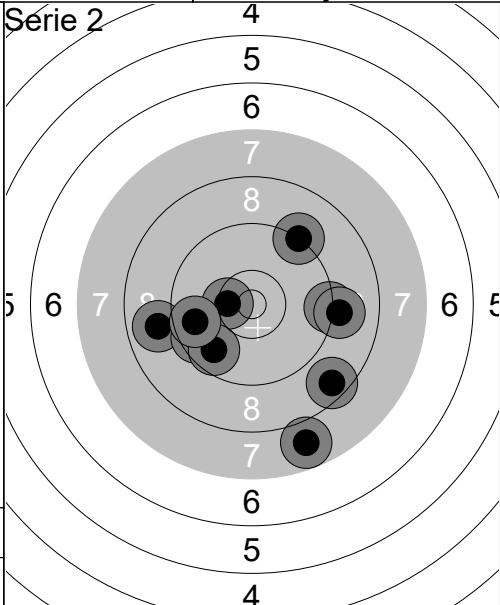

1:	8.6	↘
2:	7.8	↓
3:	10.4x	←
4:	9.3	→
5:	8.9	←
6:	9.2	↗
7:	9.6	↙
8:	9.1	→
9:	9.7	↙
10:	9.7	←
Serie		87 (1x)
Total		180 (4x)

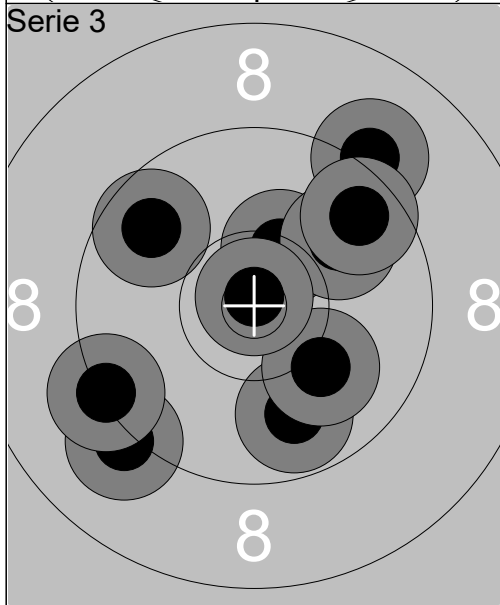

1:	9.1	↙
2:	9.1	↗
3:	10.3	↗
4:	9.8	↓
5:	9.9	↗
6:	9.7	↖
7:	9.3	←
8:	10.1	↘
9:	9.6	↗
10:	10.9x	↑
Serie		93 (1x)
Total		273 (5x)

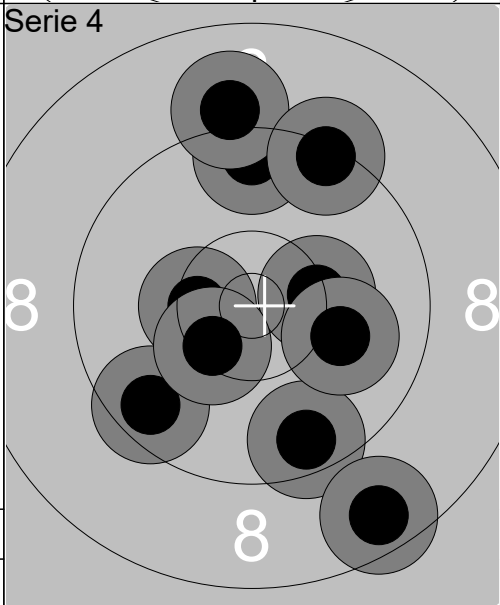

1:	9.5	↑
2:	9.0	↑
3:	9.3	↗
4:	9.6	↓
5:	9.6	↙
6:	10.4x	←
7:	10.3	→
8:	10.0	→
9:	10.4x	↙
10:	8.6	↘
Serie		93 (2x)
Total		366 (7x)

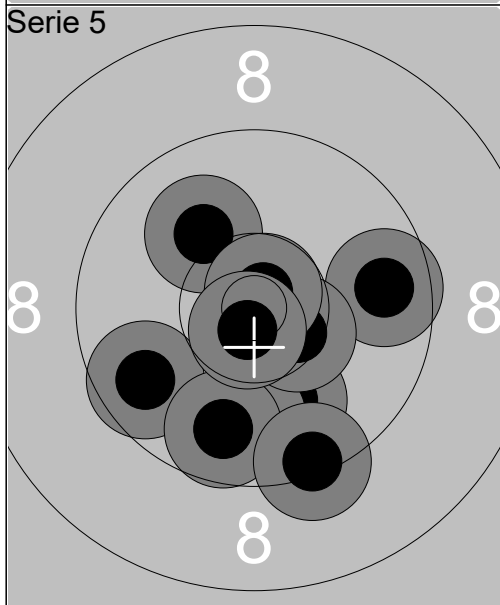

1:	9.7	→
2:	10.0	↓
3:	9.9	↓
4:	10.5x	→
5:	9.7	←
6:	9.7	↓
7:	10.1	↖
8:	10.8x	↗
9:	9.4	↓
10:	10.7x	↘
Serie		95 (3x)
Total		461 (10x)

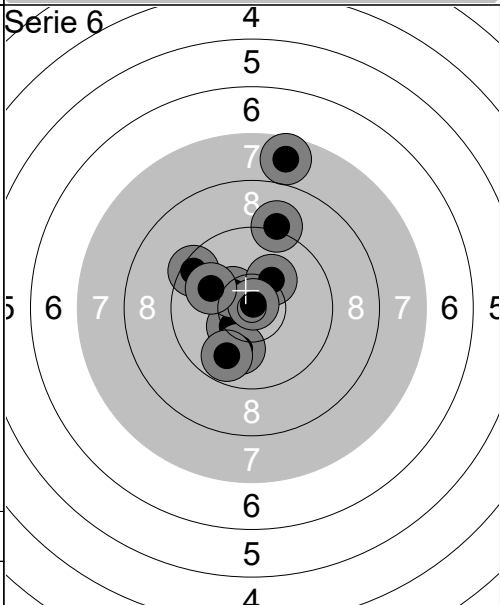

1:	7.7	↑
2:	10.4x	↙
3:	10.0	↓
4:	9.8	↙
5:	10.4x	↖
6:	10.2	↗
7:	9.5	↖
8:	10.9x	↗
9:	9.1	↑
10:	10.0	↖
Serie		94 (3x)
Total		555 (13x)

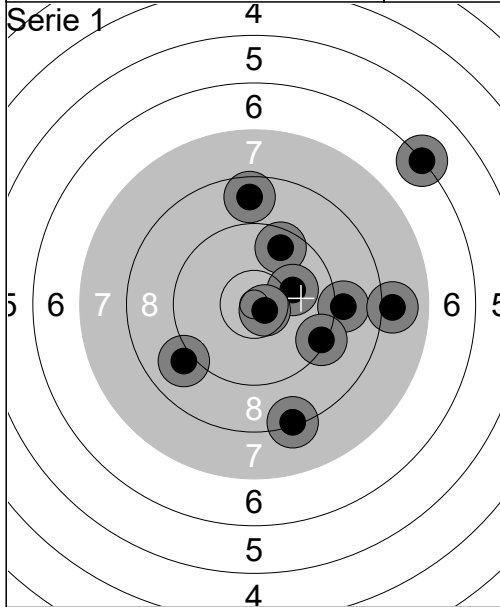

1:	9.0	↙
2:	9.0	→
3:	9.3	↘
4:	9.6	↗
5:	8.3	↓
6:	8.0	→
7:	6.2	↗
8:	10.1	→
9:	10.7x	↘
10:	8.7	↑
Serie		86 (1x)
Total		86 (1x)

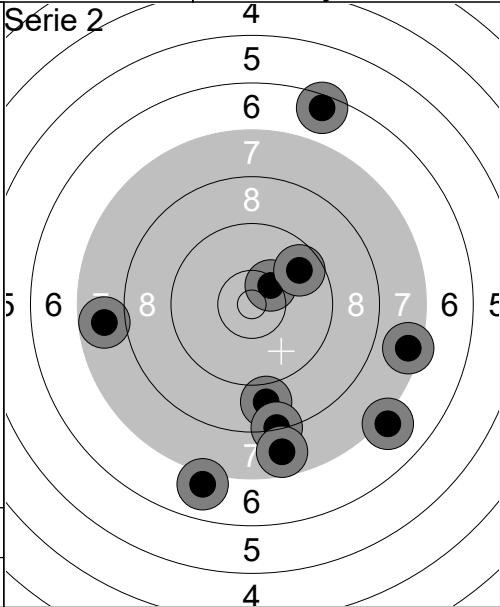

1:	10.4x	↗
2:	8.8	↓
3:	8.3	↓
4:	7.5	→
5:	6.5	↗
6:	7.8	←
7:	9.7	↗
8:	7.1	↘
9:	7.7	↓
10:	7.0	↓
Serie		76 (1x)
Total		162 (2x)

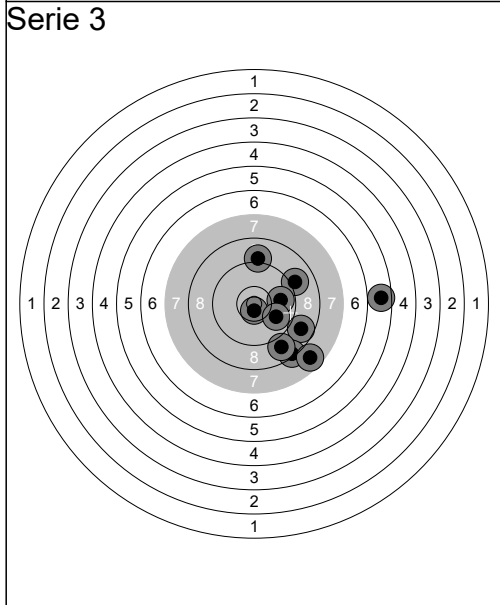

1:	8.7	↘
2:	8.3	↓
3:	5.7	→
4:	8.8	↓
5:	7.7	↘
6:	10.7x	↓
7:	9.0	↗
8:	9.8	→
9:	9.1	↑
10:	9.9	↘
Serie		82 (1x)
Total		244 (3x)

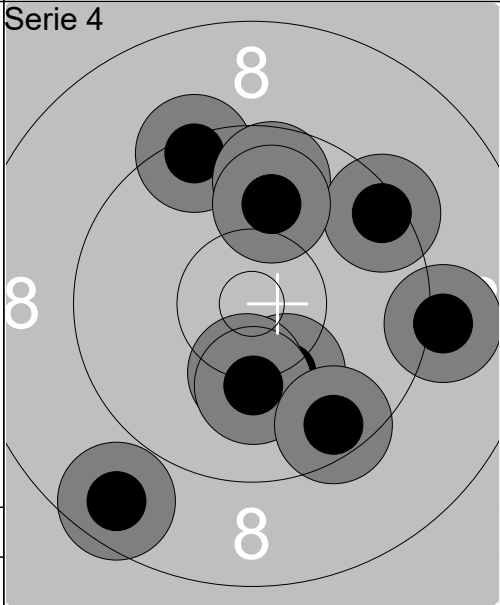

1:	9.4	↗
2:	10.2	↓
3:	10.3	↓
4:	9.7	↑
5:	10.2	↓
6:	9.1	→
7:	9.4	↗
8:	8.6	↙
9:	10.0	↑
10:	9.5	↘
Serie		93 (0x)
Total		337 (3x)

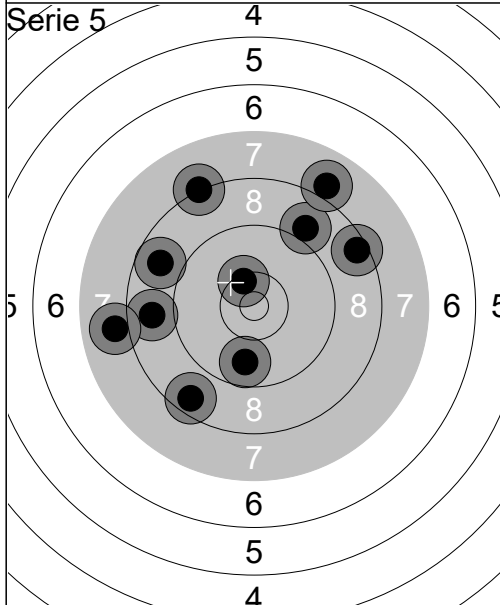

1:	8.8	←
2:	8.8	↖
3:	7.9	←
4:	8.6	↙
5:	9.7	↓
6:	8.2	↗
7:	9.0	↗
8:	8.0	↗
9:	10.4x	↗
10:	8.5	↗
Serie		83 (1x)
Total		420 (4x)

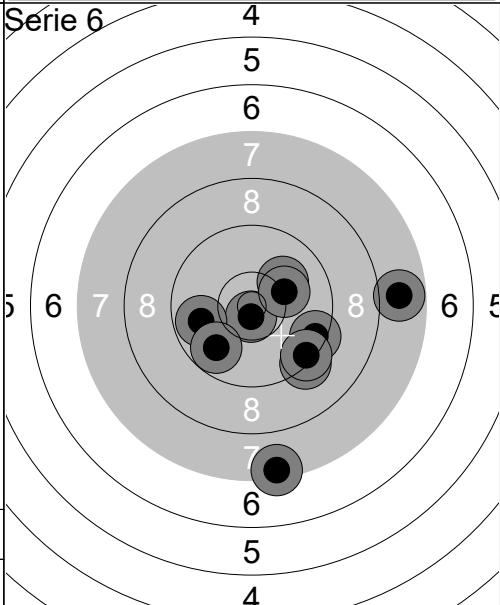

1:	10.7x	↓
2:	9.4	→
3:	9.3	↘
4:	9.4	↘
5:	10.1	↗
6:	10.2	→
7:	9.8	←
8:	7.8	→
9:	9.8	↙
10:	7.4	↓
Serie		89 (1x)
Total		509 (5x)

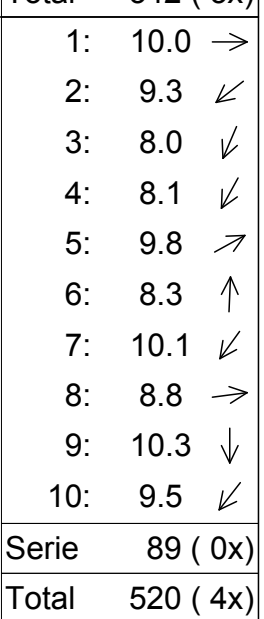
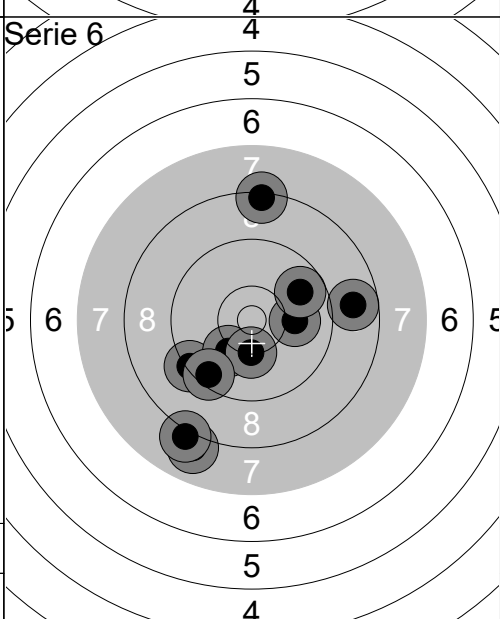
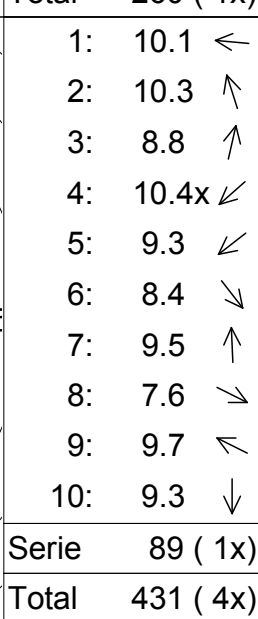
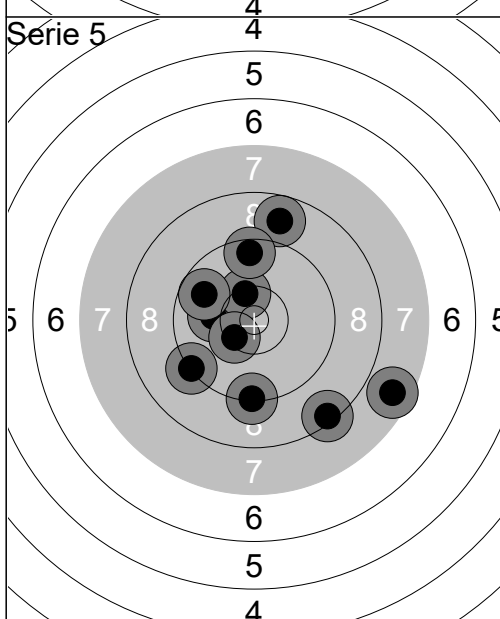
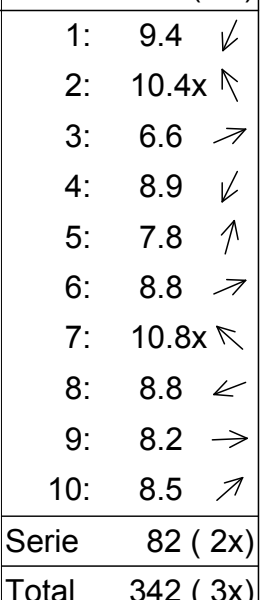
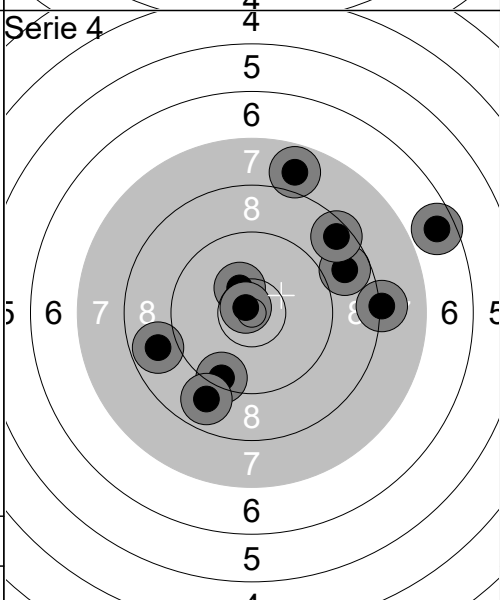
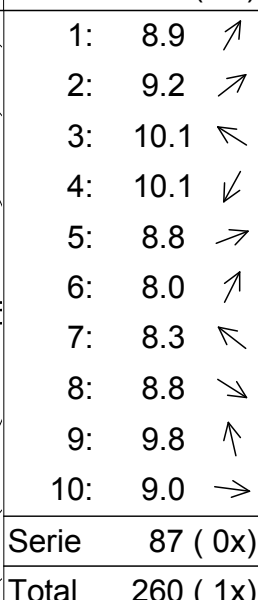
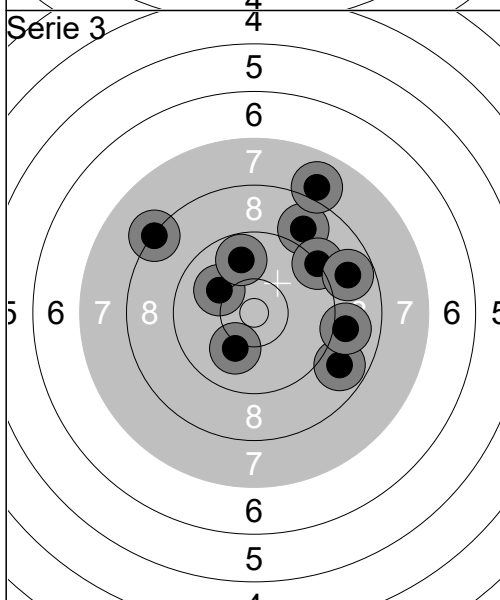
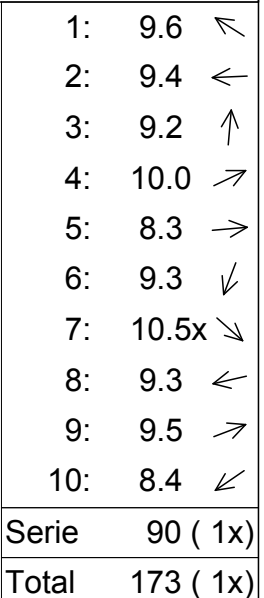
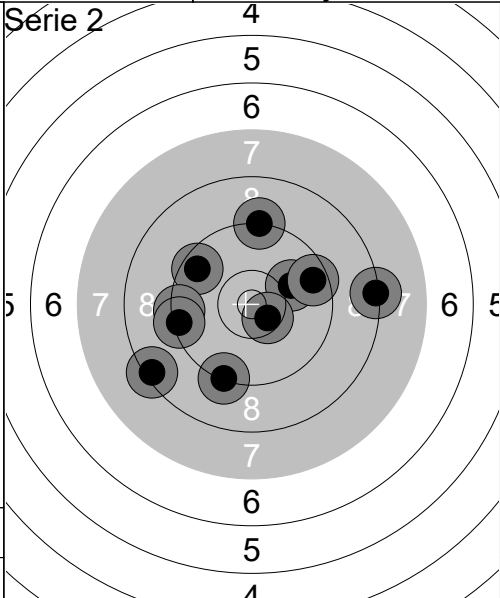
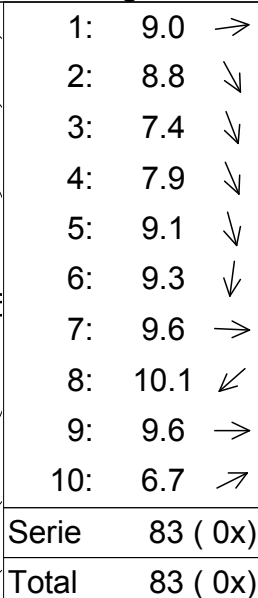
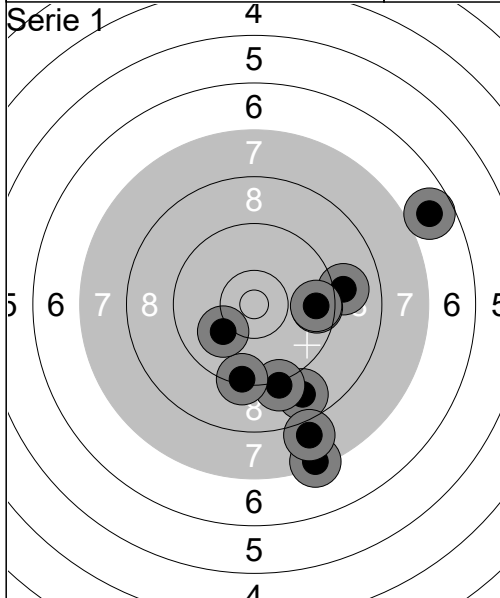

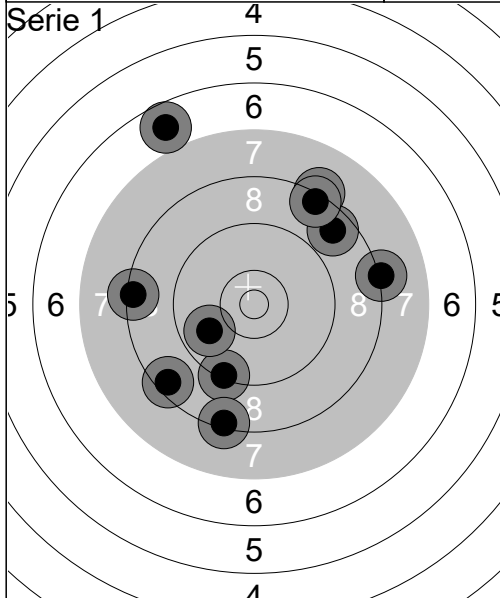

1:	9.3	↘
2:	8.4	←
3:	8.2	→
4:	8.5	↙
5:	8.6	↗
6:	8.3	↓
7:	9.8	↙
8:	8.2	↗
9:	8.4	↗
10:	6.7	↖
Serie		80 (0x)
Total		80 (0x)

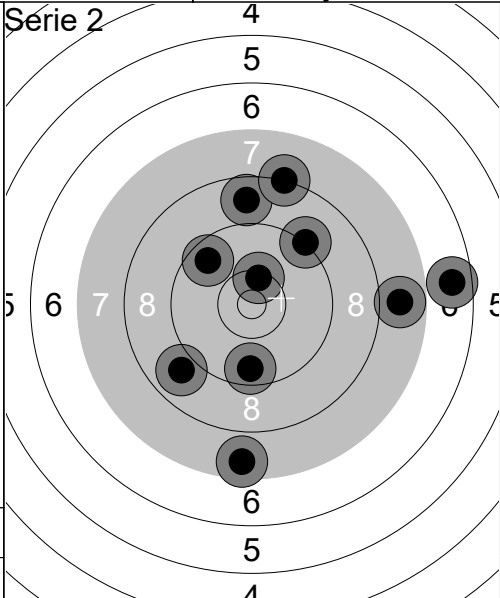

1:	8.9	↘
2:	7.6	↓
3:	9.6	↓
4:	10.4x	↑
5:	7.8	→
6:	8.7	↑
7:	9.6	↖
8:	9.2	↗
9:	6.7	→
10:	8.2	↑
Serie		81 (1x)
Total		161 (1x)

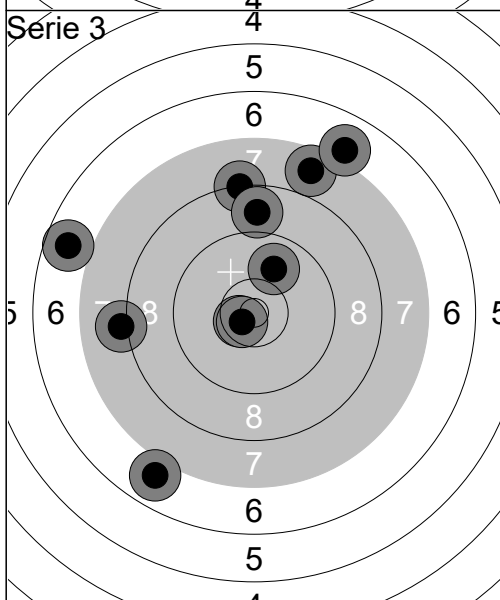

1:	10.6x	↙
2:	6.7	←
3:	6.9	↘
4:	10.6x	↙
5:	8.1	←
6:	7.7	↑
7:	7.0	↗
8:	8.2	↑
9:	8.8	↑
10:	9.9	↑
Serie		79 (2x)
Total		240 (3x)

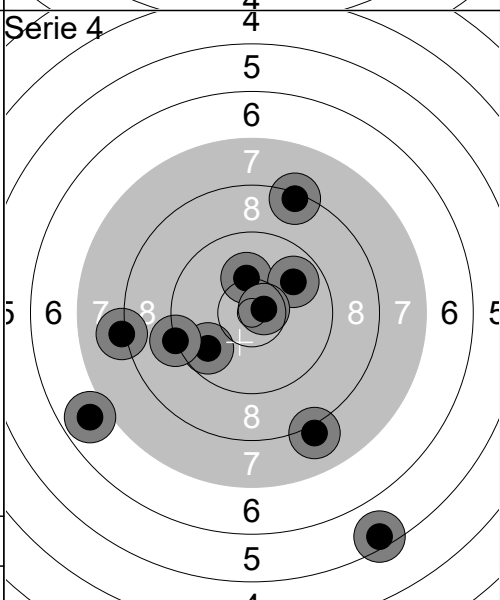

1:	10.2	↑
2:	9.7	↙
3:	8.4	↗
4:	8.1	↓
5:	8.1	←
6:	9.8	↗
7:	6.9	↙
8:	5.5	↓
9:	10.7x	→
10:	9.2	↙
Serie		82 (1x)
Total		322 (4x)

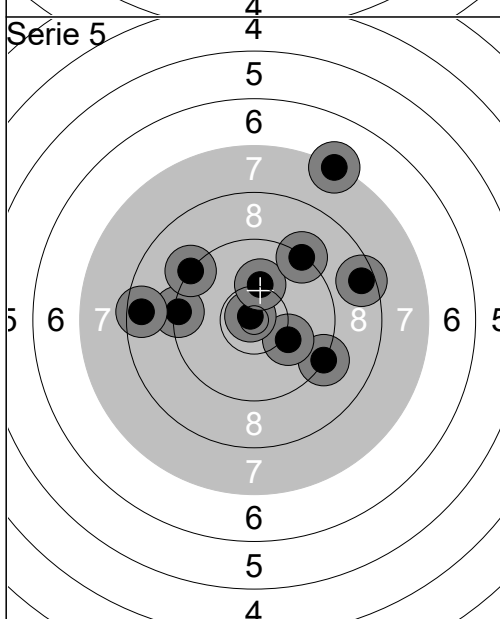

1:	9.2	→
2:	9.3	←
3:	10.1	→
4:	10.8x	↖
5:	10.2	↑
6:	9.3	↗
7:	9.2	↖
8:	8.5	←
9:	8.5	→
10:	7.3	↗
Serie		89 (1x)
Total		411 (5x)

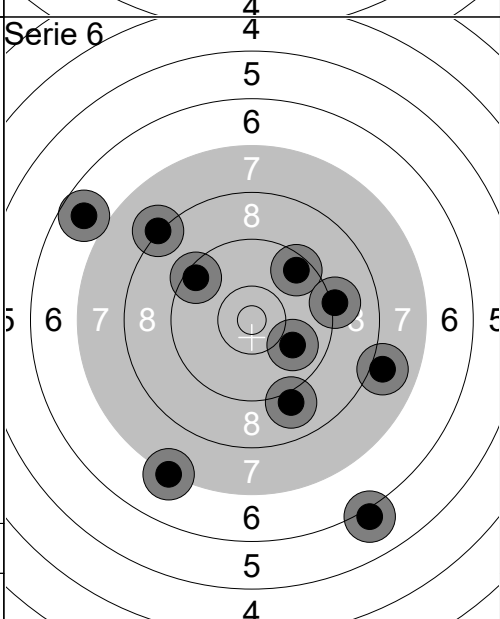

1:	9.5	↖
2:	9.0	↓
3:	6.7	↗
4:	8.2	↗
5:	9.5	↗
6:	9.9	↘
7:	7.2	↓
8:	6.1	↓
9:	8.0	→
10:	9.1	→
Serie		80 (0x)
Total		491 (5x)