

1:	7.3	←
2:	8.4	↓
3:	9.5	→
4:	8.7	↓
5:	10.4x	↗
6:	7.8	←
7:	10.4x	↙
8:	9.4	→
9:	8.7	↑
10:	9.6	↘
Serie		85 (2x)
Total		85 (2x)

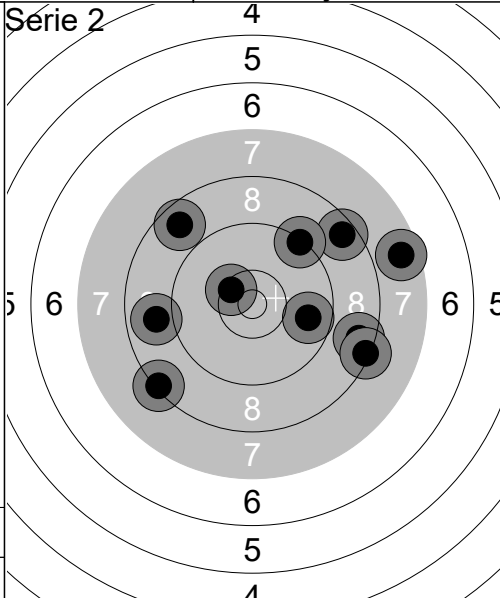

1:	8.9	←
2:	8.5	↗
3:	7.6	→
4:	8.6	↘
5:	8.3	↙
6:	8.7	↗
7:	8.3	↘
8:	9.3	↗
9:	10.4x	↙
10:	9.7	→
Serie		83 (1x)
Total		168 (3x)

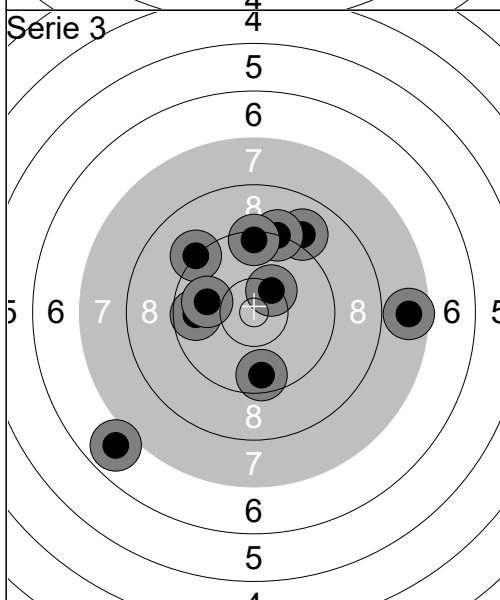

1:	6.9	↙
2:	7.6	→
3:	9.0	↗
4:	10.4	↗
5:	9.2	↑
6:	9.2	↗
7:	9.7	←
8:	9.6	↓
9:	9.9	←
10:	9.4	↑
Serie		86 (0x)
Total		254 (3x)

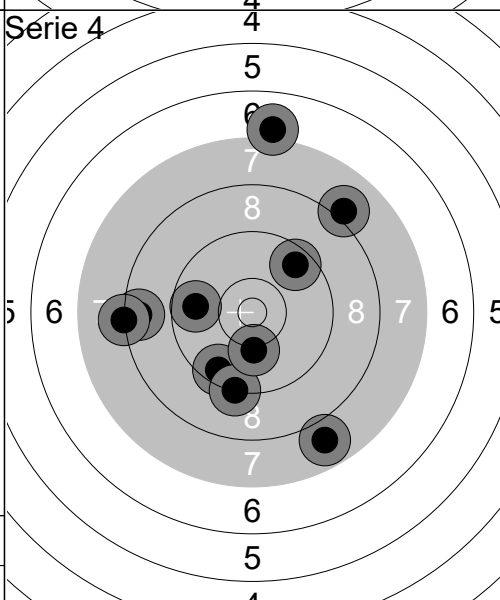

1:	8.5	←
2:	9.7	←
3:	8.0	↗
4:	9.5	↓
5:	7.0	↑
6:	9.3	↓
7:	9.6	↗
8:	10.1	↓
9:	7.8	↓
10:	8.2	←
Serie		84 (0x)
Total		338 (3x)

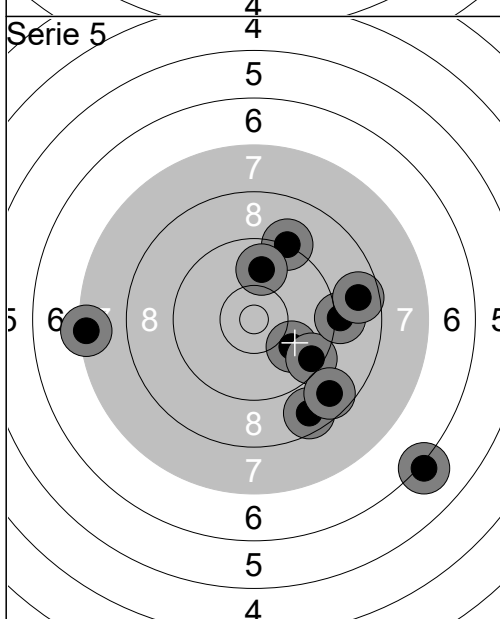

1:	7.4	←
2:	8.6	↓
3:	10.0	↘
4:	9.5	↘
5:	6.1	↘
6:	9.2	↗
7:	9.9	↑
8:	8.7	↓
9:	9.1	→
10:	8.7	→
Serie		83 (0x)
Total		421 (3x)

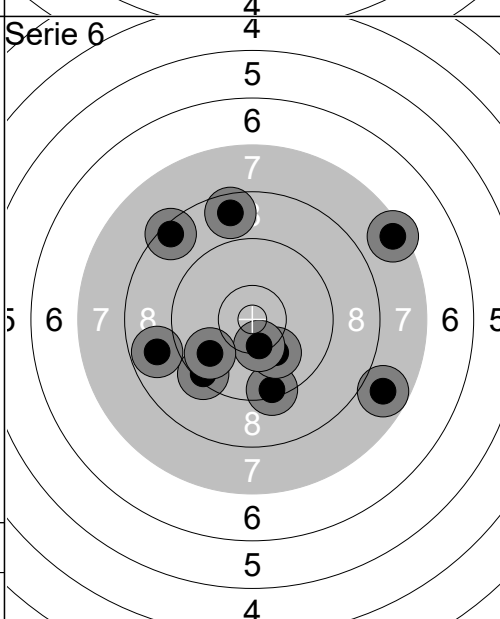

1:	9.4	↙
2:	7.5	↗
3:	8.6	↑
4:	8.8	←
5:	9.4	↓
6:	10.1	↓
7:	7.8	↘
8:	8.4	↗
9:	10.4x	↓
10:	9.8	↙
Serie		85 (1x)
Total		506 (4x)

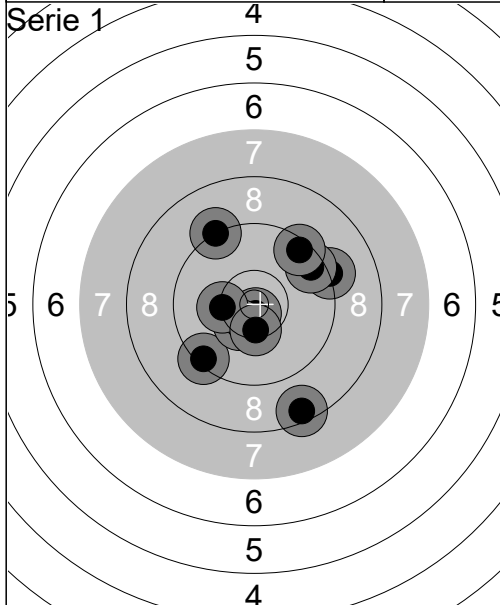

1:	9.2	↖
2:	9.2	→
3:	8.5	↓
4:	9.4	↙
5:	9.5	↗
6:	10.7x	↓
7:	10.4x	↙
8:	9.4	↗
9:	10.3	←
10:	10.4x	↓
Serie		93 (3x)
Total		93 (3x)

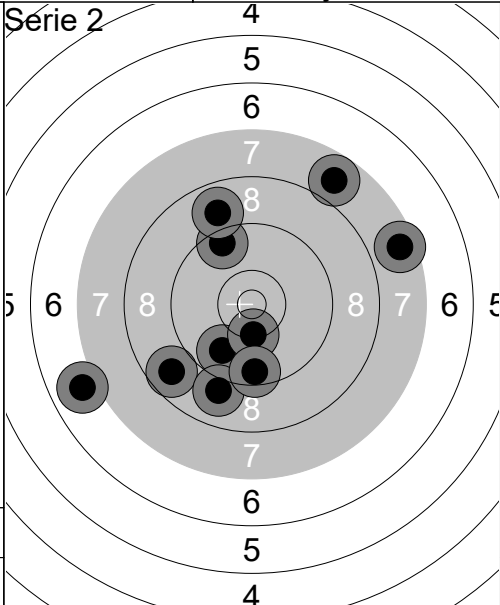

1:	6.9	↙
2:	8.7	↙
3:	9.8	↙
4:	9.0	↙
5:	10.3	↓
6:	7.8	↗
7:	7.6	→
8:	9.5	↗
9:	8.9	↗
10:	9.5	↓
Serie		82 (0x)
Total		175 (3x)

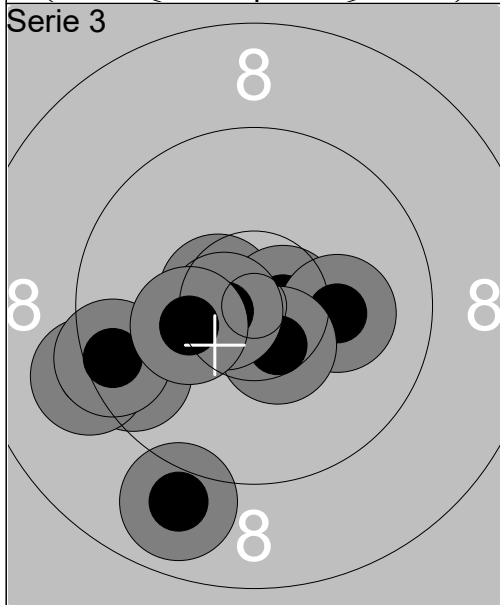

1:	9.6	↙
2:	10.6x	↙
3:	10.7x	→
4:	10.1	→
5:	10.5x	↓
6:	9.2	←
7:	10.7x	←
8:	9.5	←
9:	10.3	←
10:	8.9	↓
Serie		95 (4x)
Total		270 (7x)

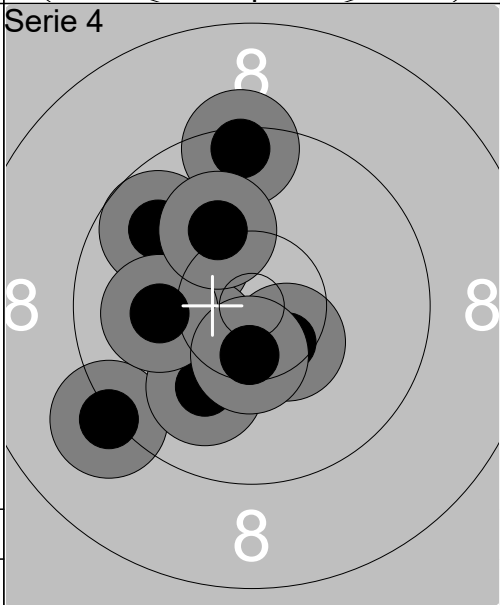

1:	10.2	↖
2:	9.2	↙
3:	9.8	↖
4:	10.4x	↙
5:	10.1	↙
6:	10.5x	↙
7:	9.4	↑
8:	10.1	←
9:	10.2	↗
10:	10.5x	↓
Serie		97 (3x)
Total		367 (10x)

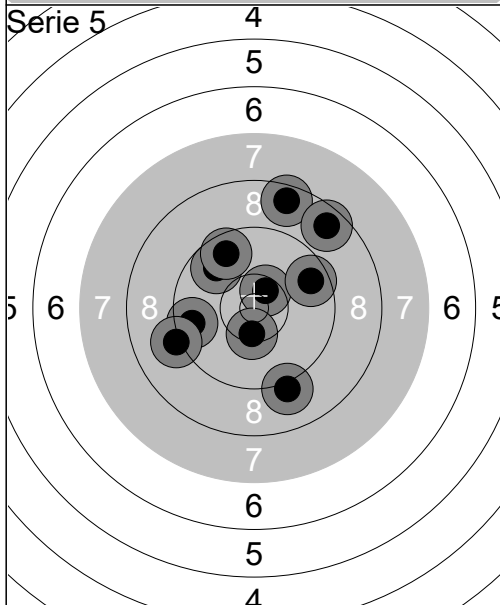

1:	9.6	←
2:	9.1	←
3:	8.6	↑
4:	9.8	↖
5:	9.6	↗
6:	10.5x	↗
7:	10.4x	↓
8:	8.6	↗
9:	9.1	↓
10:	9.6	↗
Serie		90 (2x)
Total		457 (12x)

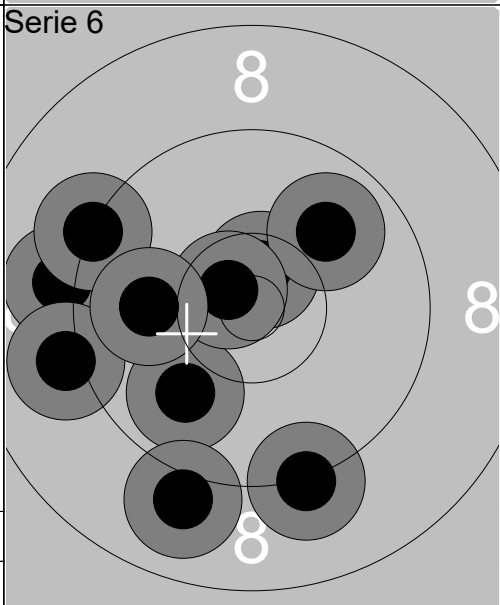

1:	9.9	↙
2:	9.2	↓
3:	9.0	↓
4:	9.1	←
5:	10.6x	↑
6:	9.9	↗
7:	9.2	↖
8:	9.1	←
9:	10.6x	↖
10:	10.0	←
Serie		93 (2x)
Total		550 (14x)

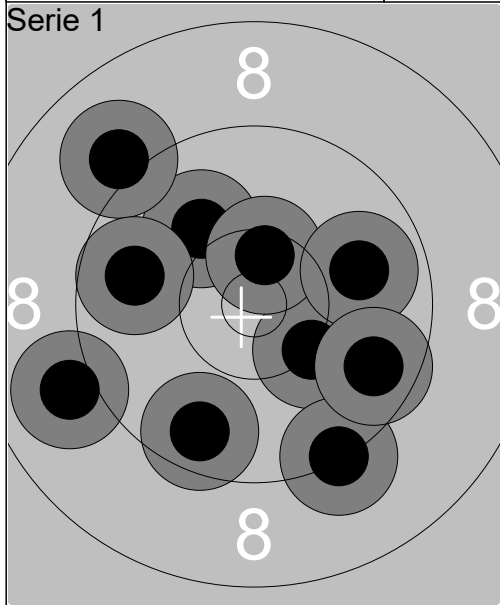

1:	10.0	↖
2:	10.2	↘
3:	10.5x	↗
4:	9.6	↘
5:	9.9	→
6:	9.3	↘
7:	9.0	←
8:	9.0	↗
9:	9.6	↘
10:	9.8	←
Serie		93 (1x)
Total		93 (1x)

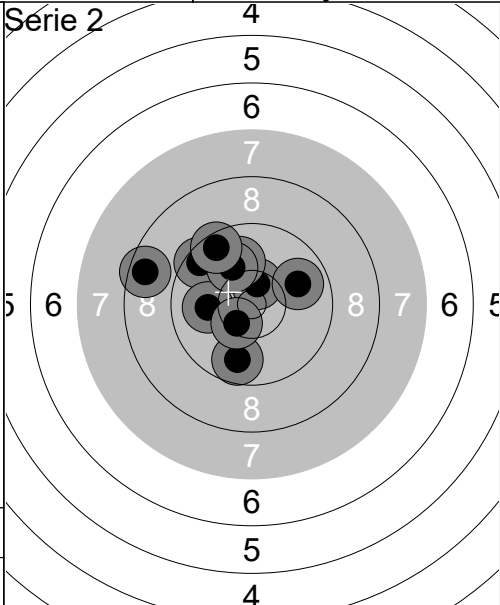

1:	9.7	↘
2:	8.6	←
3:	9.5	↖
4:	10.0	←
5:	10.5x	↗
6:	10.0	↗
7:	10.0	↗
8:	9.9	→
9:	9.5	↖
10:	10.4x	↘
Serie		94 (2x)
Total		187 (3x)

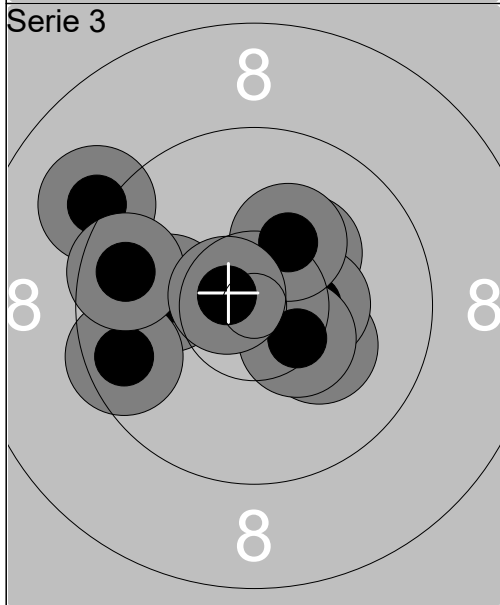

1:	10.2	↗
2:	10.2	↘
3:	10.1	←
4:	10.4x	→
5:	9.1	↖
6:	10.4x	↘
7:	9.6	←
8:	10.3	↗
9:	9.7	←
10:	10.7x	←
Serie		97 (3x)
Total		284 (6x)

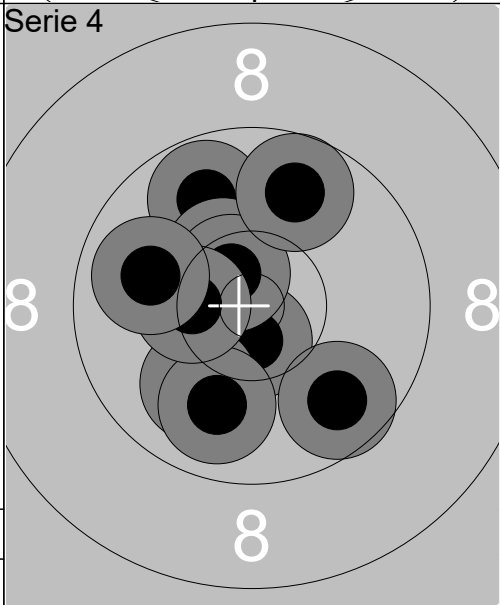

1:	10.6x	↘
2:	9.8	↗
3:	10.0	↘
4:	10.4x	↗
5:	10.6x	↗
6:	9.9	↘
7:	10.4x	←
8:	9.9	←
9:	9.7	↘
10:	9.8	↗
Serie		95 (4x)
Total		379 (10x)

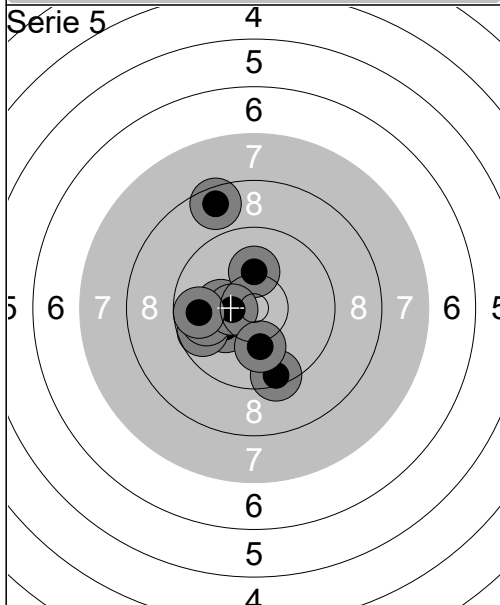

1:	10.2	↖
2:	10.2	←
3:	9.4	↘
4:	10.2	↗
5:	9.7	↖
6:	9.9	←
7:	10.5x	←
8:	10.1	↘
9:	9.8	←
10:	8.6	↗
Serie		94 (1x)
Total		473 (11x)

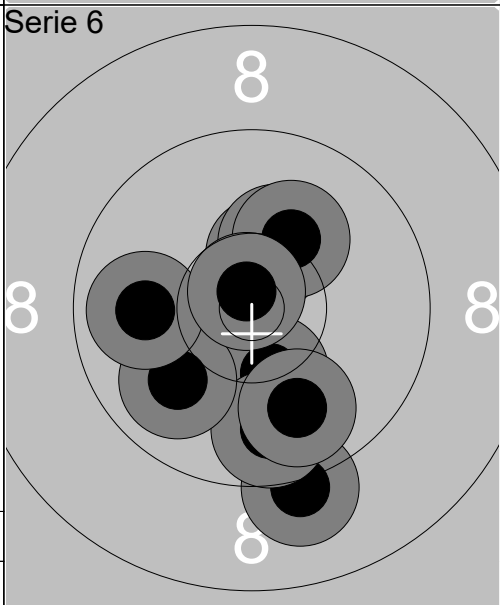

1:	10.3	↘
2:	9.2	↘
3:	10.4x	↗
4:	9.8	↘
5:	10.3	↗
6:	10.0	↖
7:	10.2	↗
8:	9.9	←
9:	9.9	↘
10:	10.8x	↗
Serie		96 (2x)
Total		569 (13x)

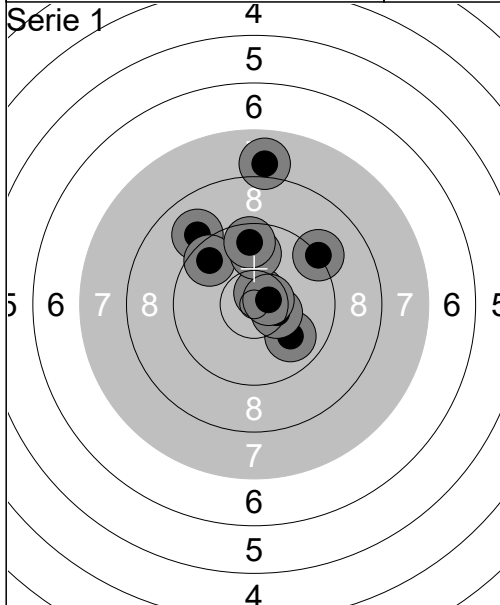

1:	9.0	↘
2:	7.9	↑
3:	9.6	↖
4:	9.2	↗
5:	9.9	↘
6:	10.7x	↗
7:	9.9	↑
8:	10.4x	→
9:	10.6x	→
10:	9.6	↑
Serie		91 (3x)
Total		91 (3x)

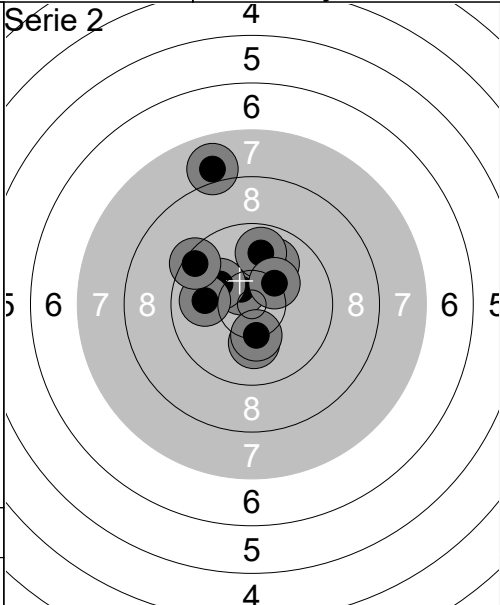

1:	10.5x	↖
2:	10.1	↖
3:	7.9	↑
4:	9.9	←
5:	9.9	↗
6:	10.1	↓
7:	9.5	↖
8:	9.8	↑
9:	10.3	↓
10:	10.3	↗
Serie		93 (1x)
Total		184 (4x)

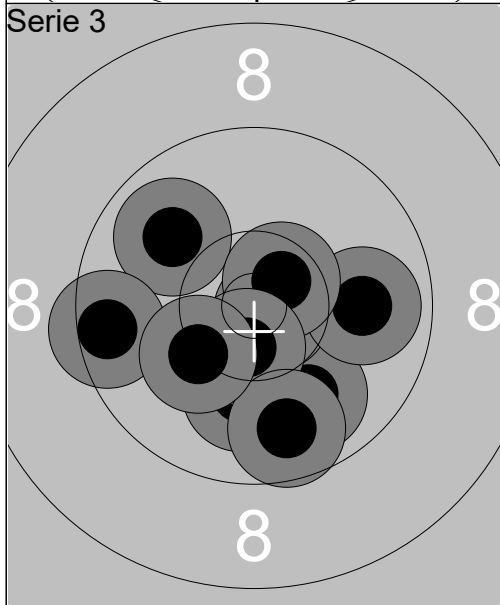

1:	9.9	↘
2:	9.9	↖
3:	10.8x	→
4:	9.5	←
5:	9.9	→
6:	10.1	↓
7:	10.6x	↗
8:	10.5x	↓
9:	9.7	↓
10:	10.2	↙
Serie		95 (3x)
Total		279 (7x)

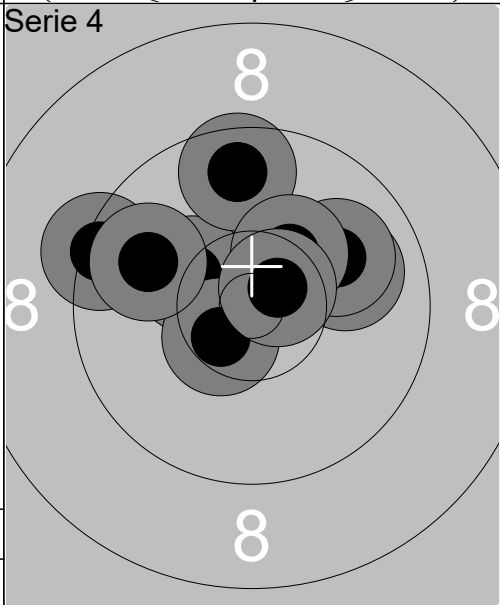

1:	10.0	→
2:	10.5x	↗
3:	10.0	↗
4:	10.3	↖
5:	10.5x	↙
6:	9.6	↑
7:	9.4	←
8:	10.3	↗
9:	10.6x	↗
10:	9.9	←
Serie		97 (3x)
Total		376 (10x)

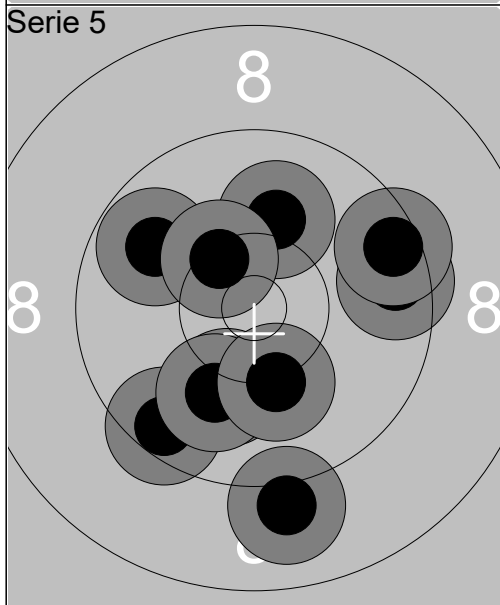

1:	9.5	↙
2:	10.1	↙
3:	9.0	↓
4:	9.8	↖
5:	9.6	→
6:	9.5	→
7:	10.1	↑
8:	10.0	↙
9:	10.2	↓
10:	10.4x	↖
Serie		95 (1x)
Total		471 (11x)

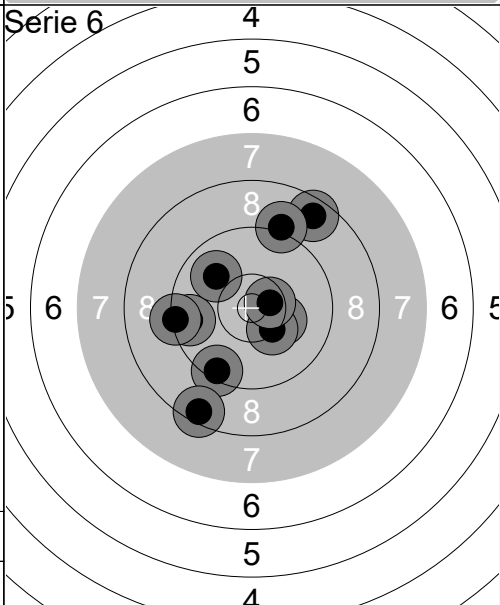

1:	10.3	→
2:	10.3	↘
3:	10.5x	→
4:	9.4	↙
5:	8.5	↙
6:	9.6	←
7:	8.6	↗
8:	9.9	↖
9:	9.1	↗
10:	9.3	←
Serie		91 (1x)
Total		562 (12x)

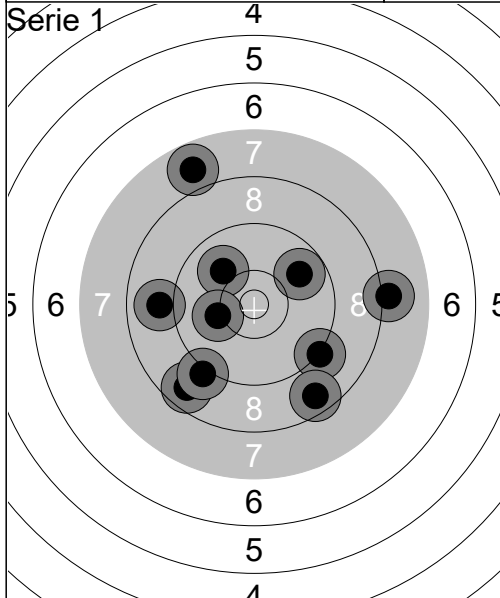

1:	8.9	←
2:	7.8	↗
3:	10.0	↗
4:	9.8	↗
5:	8.1	→
6:	8.7	↘
7:	9.2	↘
8:	9.1	↘
9:	10.1	←
10:	8.6	↘
Serie		86 (0x)
Total		86 (0x)

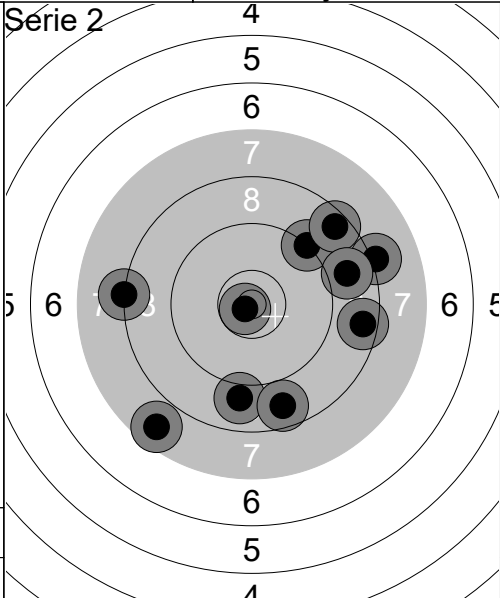

1:	10.8x	↙
2:	8.1	→
3:	9.2	↗
4:	8.5	↗
5:	8.9	↓
6:	8.7	↓
7:	7.6	↘
8:	8.8	→
9:	8.2	←
10:	8.5	→
Serie		82 (1x)
Total		168 (1x)

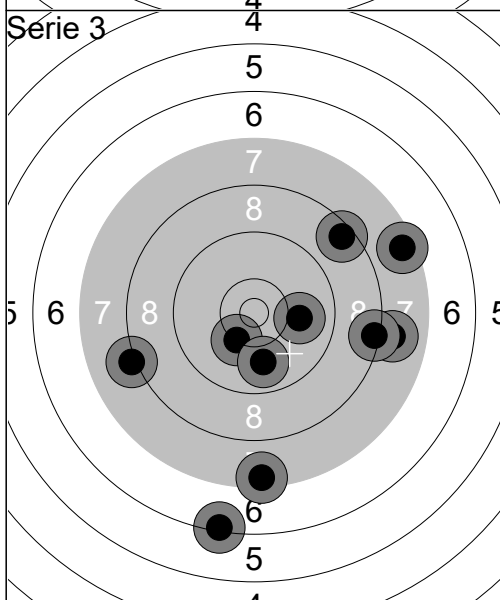

1:	10.3	↘
2:	8.0	→
3:	8.3	→
4:	8.5	↗
5:	6.3	↓
6:	8.1	←
7:	10.0	→
8:	9.9	↓
9:	7.4	↓
10:	7.5	↗
Serie		81 (0x)
Total		249 (1x)

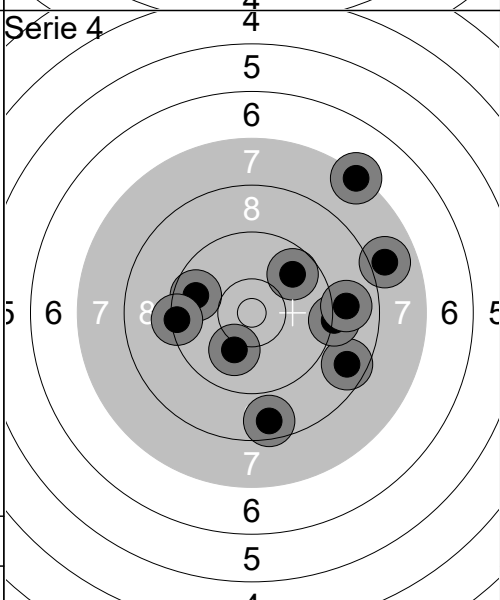

1:	8.6	↘
2:	8.6	↓
3:	9.2	→
4:	8.9	→
5:	9.7	←
6:	7.9	→
7:	10.1	↘
8:	7.3	↗
9:	9.4	←
10:	9.8	↗
Serie		84 (0x)
Total		333 (1x)

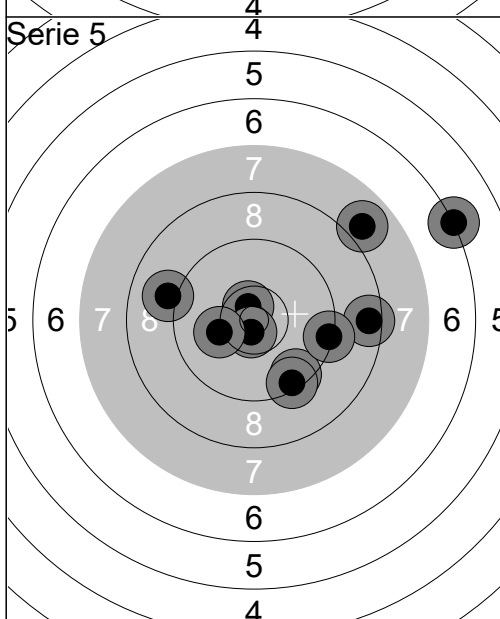

1:	10.6x	↗
2:	9.0	←
3:	9.5	↘
4:	8.5	→
5:	10.7x	↘
6:	10.2	←
7:	6.2	↗
8:	9.3	→
9:	9.4	↘
10:	7.9	↗
Serie		87 (2x)
Total		420 (3x)

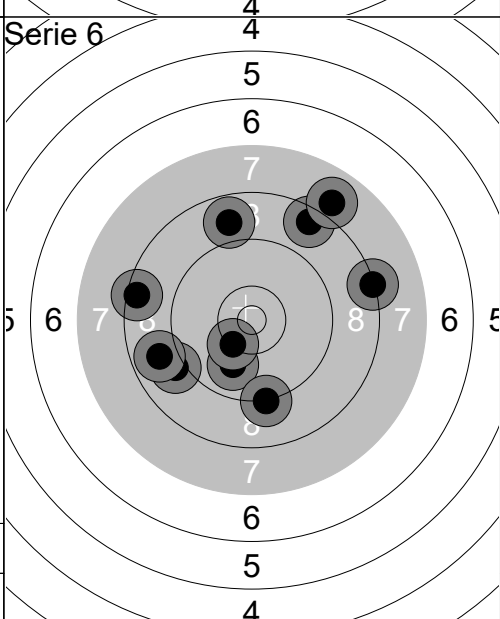

1:	8.5	↗
2:	9.9	↘
3:	8.8	↗
4:	7.9	↗
5:	8.3	→
6:	9.0	←
7:	10.3	↘
8:	8.4	←
9:	8.8	←
10:	9.2	↓
Serie		84 (0x)
Total		504 (3x)

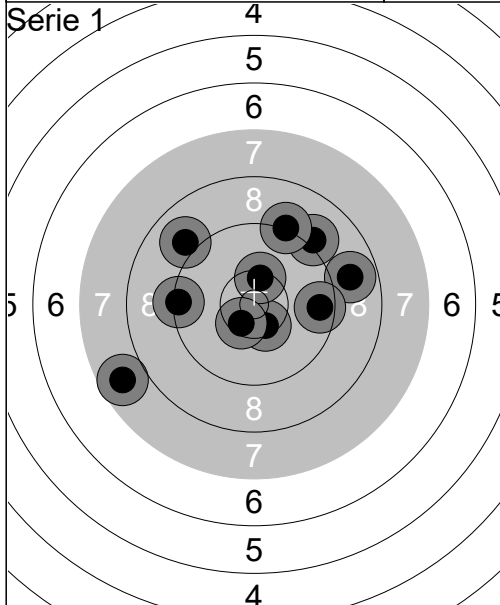

1:	8.8	→
2:	9.0	↖
3:	10.4x	↘
4:	9.5	→
5:	7.7	↙
6:	9.1	↗
7:	9.3	←
8:	10.4x	↗
9:	10.5x	↘
10:	9.2	↗
Serie		90 (3x)
Total		90 (3x)

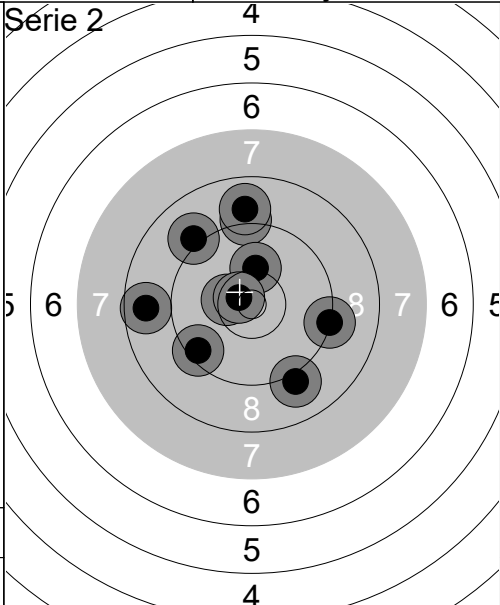

1:	10.4x	↙
2:	9.1	↗
3:	9.1	↖
4:	10.2	↗
5:	10.6x	↙
6:	9.2	→
7:	8.9	↗
8:	9.1	↘
9:	9.4	↘
10:	8.7	←
Serie		91 (2x)
Total		181 (5x)

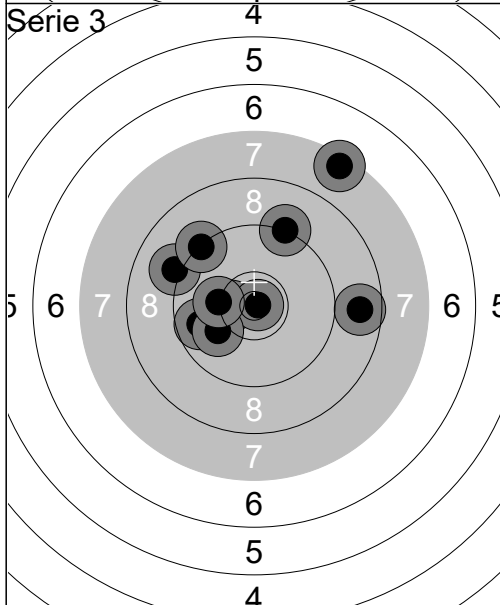

1:	10.5x	↙
2:	10.8x	→
3:	8.7	→
4:	9.1	↙
5:	9.2	↗
6:	9.7	←
7:	9.3	↗
8:	10.0	↙
9:	10.2	←
10:	7.5	↗
Serie		91 (2x)
Total		272 (7x)

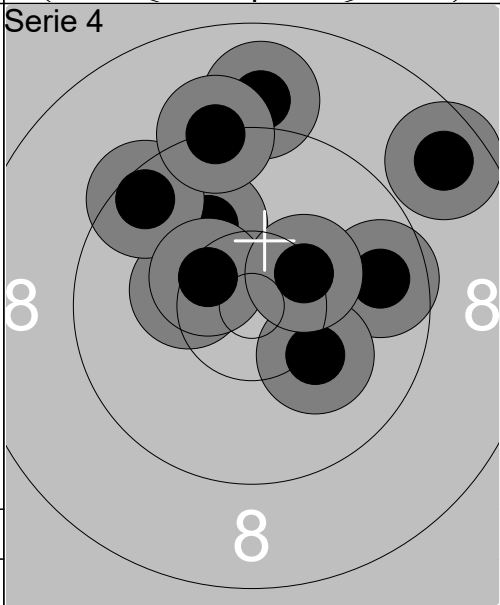

1:	10.1	↗
2:	10.3	←
3:	9.5	↖
4:	9.7	→
5:	8.6	↗
6:	10.4x	↙
7:	10.2	↘
8:	9.0	↗
9:	9.3	↗
10:	10.4	↗
Serie		94 (1x)
Total		366 (8x)

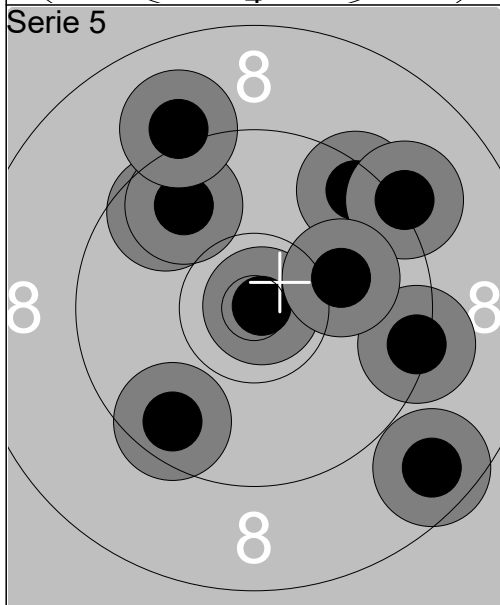

1:	9.7	↖
2:	9.5	↗
3:	9.2	↗
4:	10.9x	→
5:	9.8	↗
6:	9.3	→
7:	9.6	↘
8:	8.6	↘
9:	9.1	↗
10:	10.1	→
Serie		91 (1x)
Total		457 (9x)

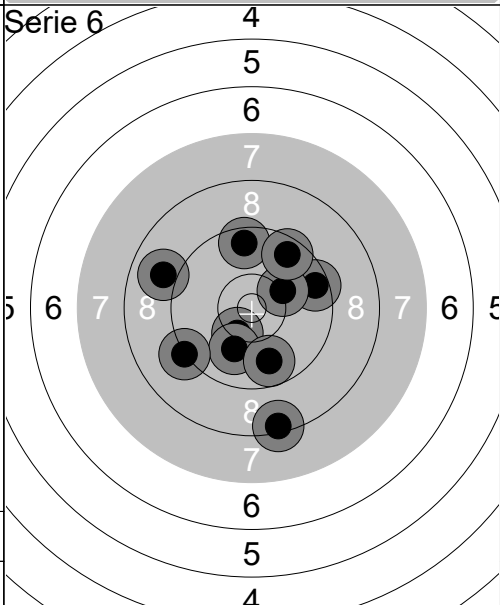

1:	8.9	↙
2:	10.3	↘
3:	9.5	↗
4:	9.5	→
5:	10.2	↗
6:	10.0	↘
7:	9.6	↗
8:	8.4	↘
9:	9.8	↘
10:	9.2	↘
Serie		91 (0x)
Total		548 (9x)

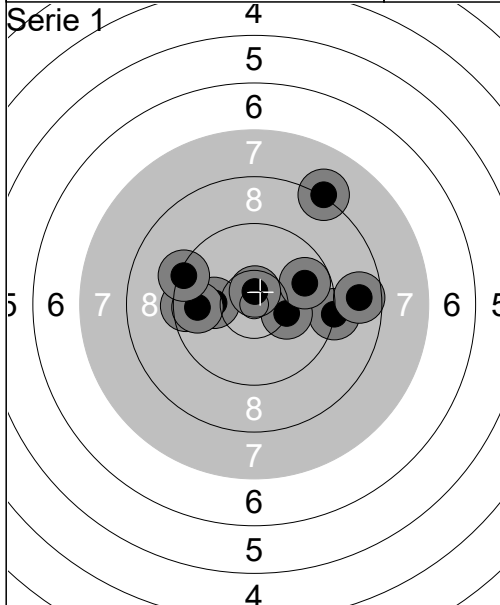

1:	9.5	←
2:	9.2	→
3:	10.2	→
4:	10.1	←
5:	9.8	→
6:	9.7	←
7:	8.7	→
8:	8.2	↗
9:	10.7x	↑
10:	9.3	←
Serie		91 (1x)
Total		91 (1x)

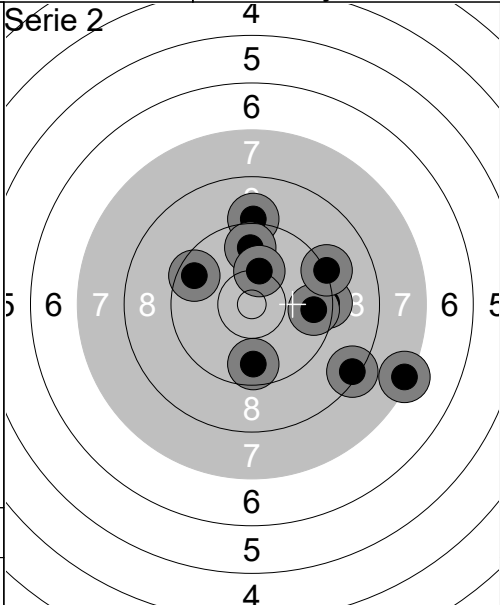

1:	9.1	↑
2:	9.4	→
3:	9.6	↖
4:	8.4	↘
5:	9.7	↑
6:	9.7	↓
7:	10.2	↑
8:	7.3	↘
9:	9.6	→
10:	9.2	↗
Serie		88 (0x)
Total		179 (1x)

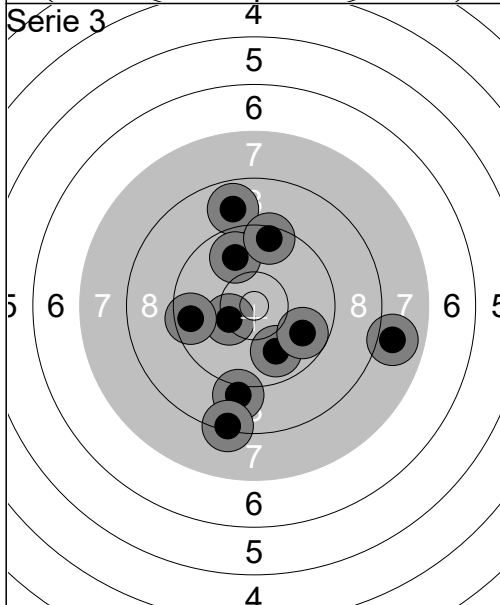

1:	8.8	↑
2:	9.8	↑
3:	9.5	↑
4:	9.0	↓
5:	9.9	↓
6:	7.9	→
7:	10.3	←
8:	9.8	↘
9:	8.3	↓
10:	9.6	←
Serie		87 (0x)
Total		266 (1x)

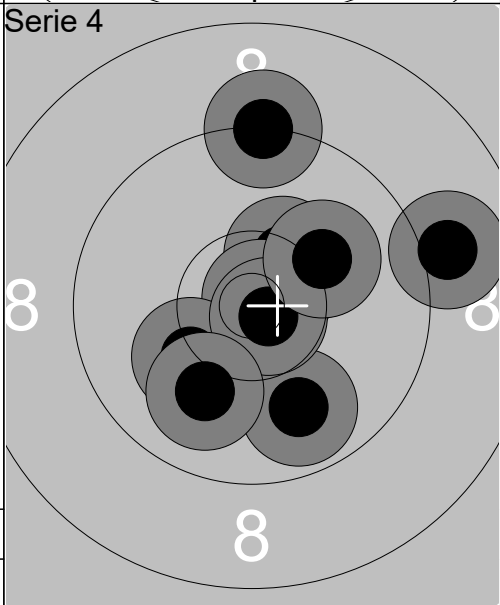

1:	10.6x	↗
2:	10.4x	↗
3:	10.8x	↗
4:	10.2	↖
5:	9.9	↓
6:	10.8x	↘
7:	9.0	→
8:	10.1	↗
9:	9.2	↑
10:	10.0	↓
Serie		97 (4x)
Total		363 (5x)

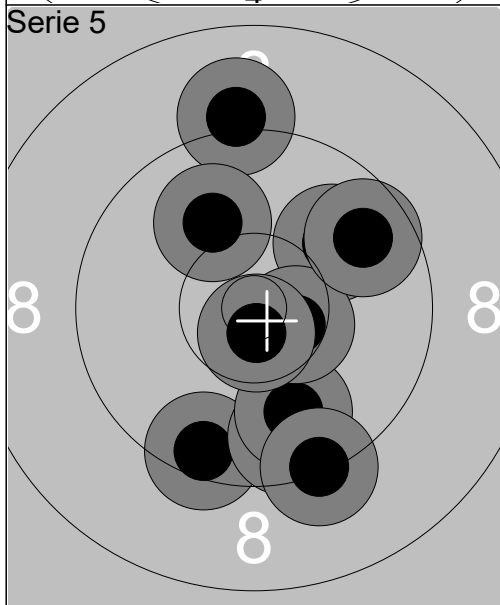

1:	9.5	↓
2:	9.7	↓
3:	10.0	↗
4:	9.9	↓
5:	9.3	↓
6:	9.1	↑
7:	10.5x	↘
8:	10.0	↗
9:	9.7	↗
10:	10.7x	↓
Serie		94 (2x)
Total		457 (7x)

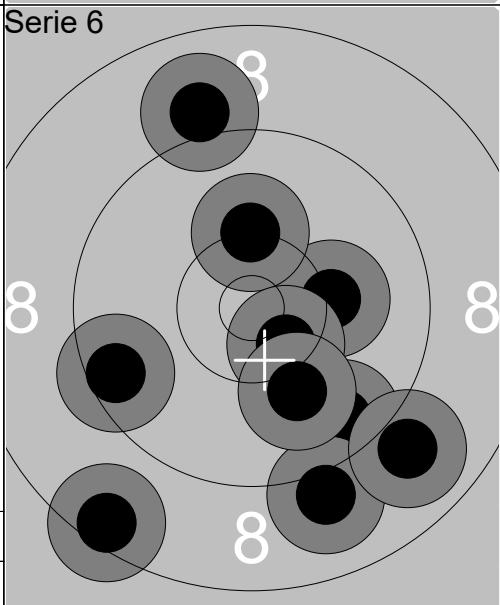

1:	10.2	→
2:	9.0	↑
3:	10.2	↑
4:	9.6	↘
5:	9.0	↓
6:	9.5	←
7:	10.5x	↘
8:	10.0	↓
9:	8.5	↖
10:	8.9	↘
Serie		92 (1x)
Total		549 (8x)

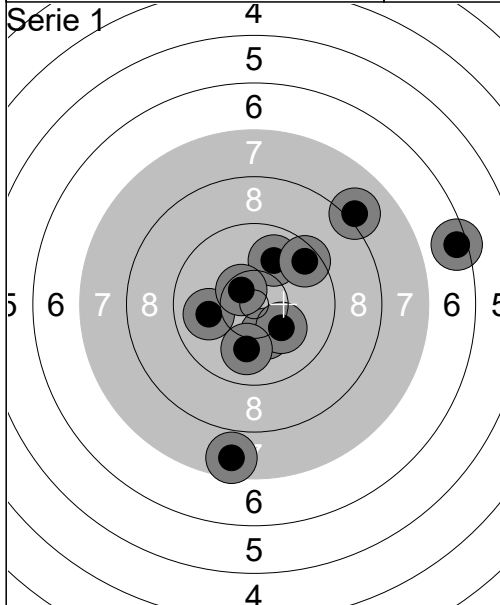

1:	10.3	↘
2:	10.2	↘
3:	9.9	↗
4:	8.1	↗
5:	10.0	←
6:	10.0	↓
7:	9.5	↗
8:	6.5	→
9:	10.5x	↖
10:	7.6	↓
Série		89 (1x)
Total		89 (1x)

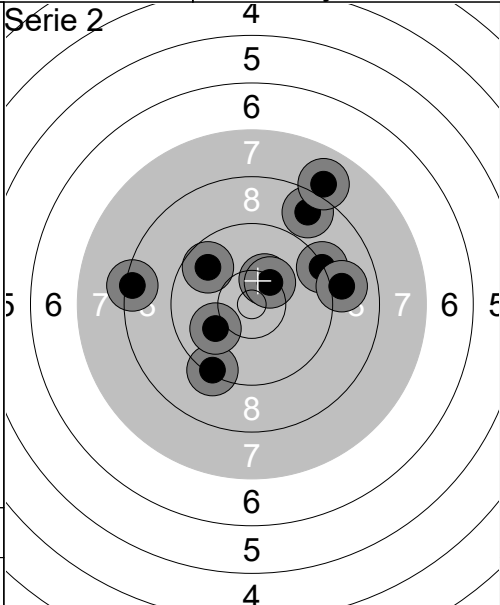

1:	10.3	↗
2:	10.3	↗
3:	9.2	↗
4:	8.7	↗
5:	9.0	→
6:	9.3	↓
7:	10.0	←
8:	8.4	←
9:	8.0	↗
10:	9.7	↖
Série		90 (0x)
Total		179 (1x)

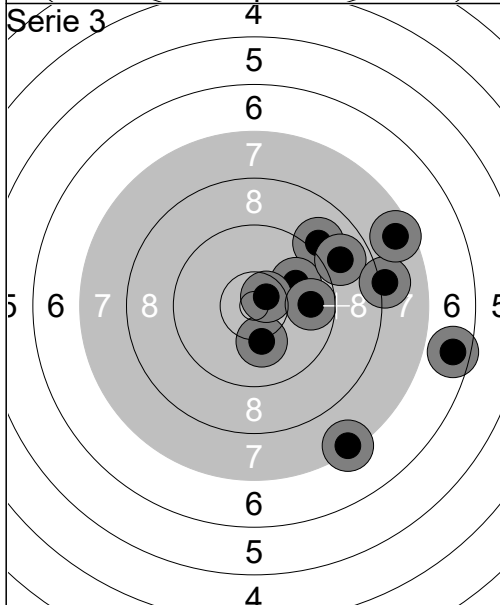

1:	9.0	↗
2:	9.9	↗
3:	10.2	↓
4:	10.6x	↗
5:	8.9	↗
6:	6.6	→
7:	9.7	→
8:	7.4	↓
9:	8.1	→
10:	7.6	↗
Série		83 (1x)
Total		262 (2x)

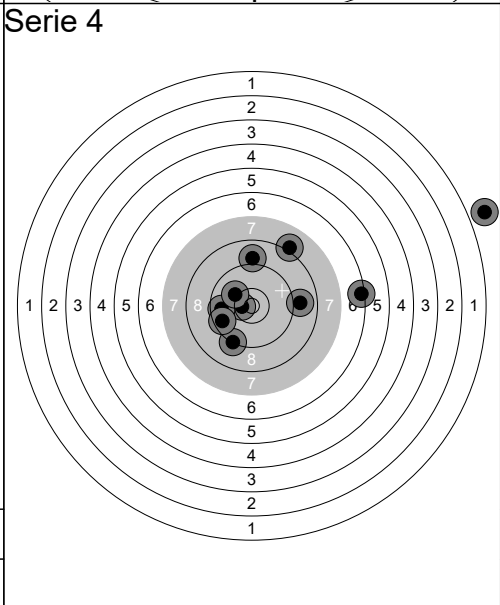

1:	0.0	→
2:	6.4	→
3:	9.0	↑
4:	10.5x	←
5:	9.2	↓
6:	9.7	←
7:	10.1	↖
8:	8.1	↗
9:	8.9	→
10:	9.6	↖
Série		78 (1x)
Total		340 (3x)

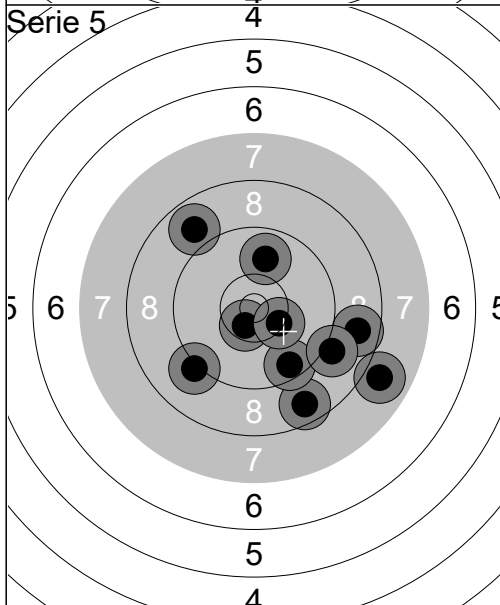

1:	8.6	↓
2:	8.7	→
3:	9.5	↓
4:	10.5x	↓
5:	9.1	↘
6:	7.9	↘
7:	9.9	↗
8:	8.8	↗
9:	9.1	↖
10:	10.3	↘
Série		87 (1x)
Total		427 (4x)

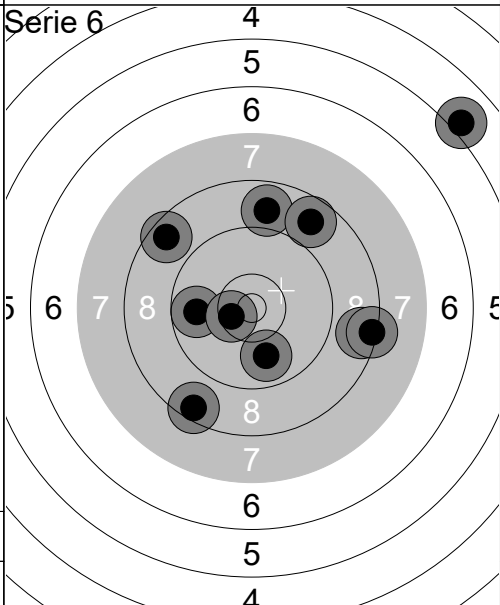

1:	5.0	↗
2:	8.5	→
3:	9.8	←
4:	8.8	↑
5:	10.5x	←
6:	8.5	↓
7:	9.9	↓
8:	8.6	↗
9:	8.3	→
10:	8.7	↗
Série		81 (1x)
Total		508 (5x)

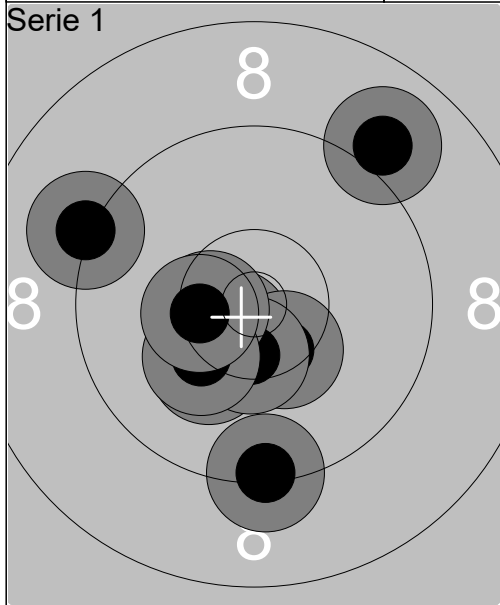

1:	10.6x ↙
2:	10.4x ↘
3:	9.3 ↓
4:	9.2 ↖
5:	9.0 ↗
6:	10.2 ↙
7:	10.5x ↓
8:	10.5x ←
9:	10.2 ↙
10:	10.4x ←
Serie	97 (5x)
Total	97 (5x)

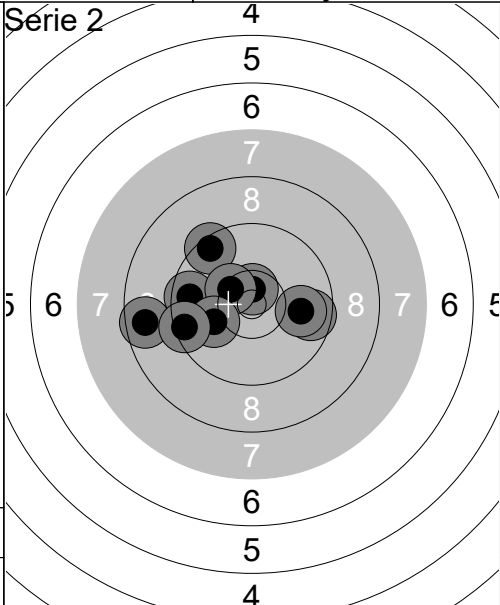

1:	10.6x ↑
2:	9.7 →
3:	9.5 ↗
4:	10.0 ←
5:	9.6 ←
6:	10.4x ↗
7:	9.9 →
8:	8.6 ←
9:	10.1 ←
10:	9.4 ←
Serie	93 (2x)
Total	190 (7x)

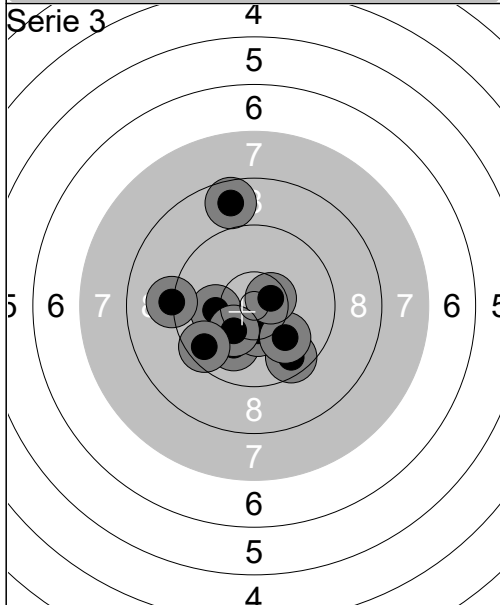

1:	10.0 ↙
2:	8.7 ↑
3:	9.6 ↘
4:	10.4x ↓
5:	10.0 ↘
6:	10.1 ←
7:	10.6x →
8:	10.2 ↙
9:	9.2 ←
10:	9.6 ↙
Serie	95 (2x)
Total	285 (9x)

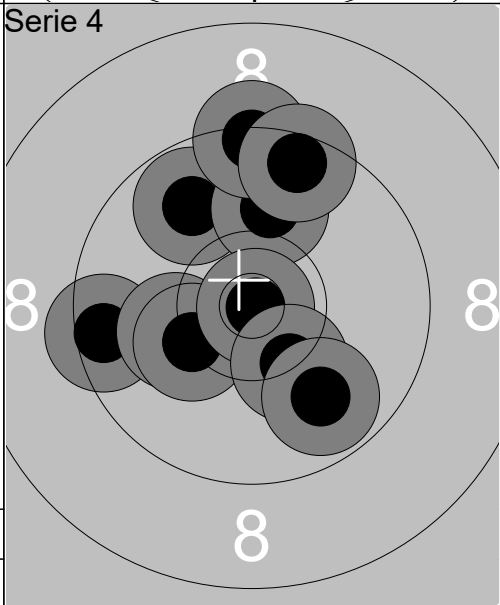

1:	9.8 ↗
2:	9.5 ←
3:	10.0 ↑
4:	10.2 ←
5:	10.3 ↖
6:	9.3 ↑
7:	10.9x →
8:	10.3 ↘
9:	9.8 ↘
10:	9.5 ↑
Serie	95 (1x)
Total	380 (10x)

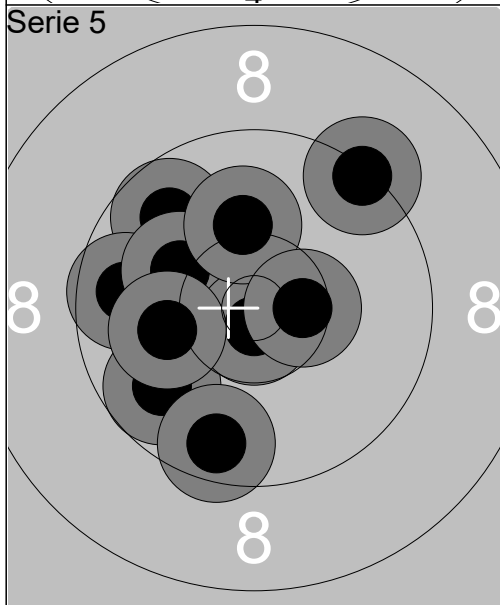

1:	9.8 ↖
2:	9.8 ↗
3:	9.7 ←
4:	10.1 ↖
5:	10.8x ↓
6:	10.1 ←
7:	9.3 ↗
8:	10.1 ↑
9:	10.5x →
10:	9.6 ↓
Serie	95 (2x)
Total	475 (12x)

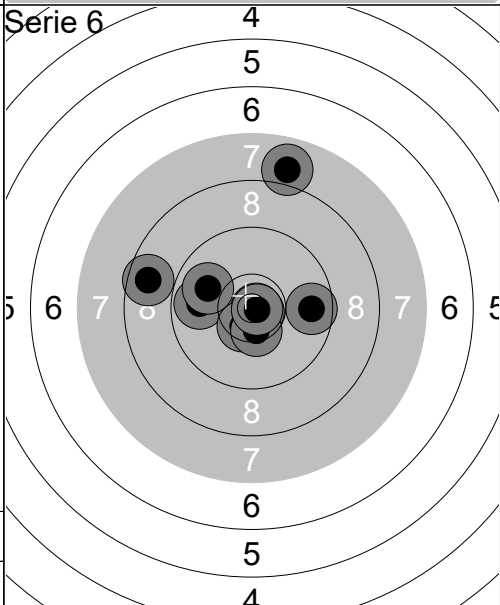

1:	10.8x →
2:	9.8 ←
3:	9.7 →
4:	8.7 ←
5:	10.5x ↙
6:	9.9 ↖
7:	10.8x →
8:	10.5x ↓
9:	10.8x →
10:	7.9 ↑
Serie	92 (5x)
Total	567 (17x)

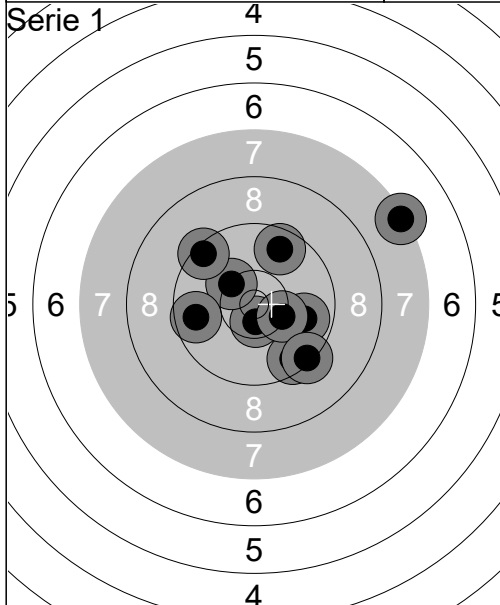

1:	9.8	→
2:	10.6x	↓
3:	7.3	→
4:	10.3	↖
5:	9.5	↓
6:	9.6	↗
7:	10.3	→
8:	9.3	↓
9:	9.4	↗
10:	9.7	←
Serie		91 (1x)
Total		91 (1x)

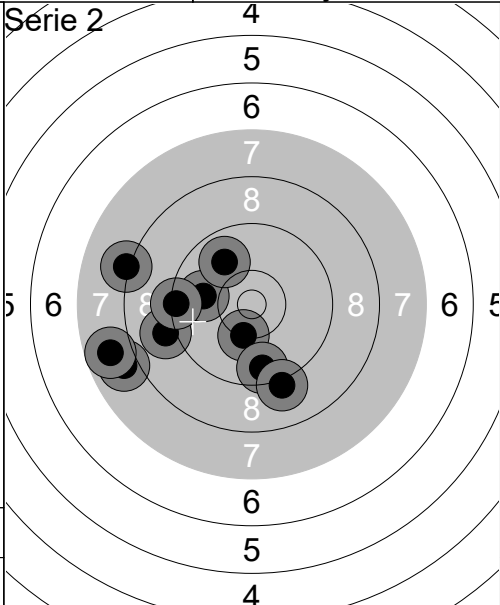

1:	10.3	↓
2:	9.6	↓
3:	9.9	←
4:	7.9	←
5:	9.1	↓
6:	8.1	←
7:	9.0	←
8:	9.9	↗
9:	7.8	←
10:	9.3	←
Serie		86 (0x)
Total		177 (1x)

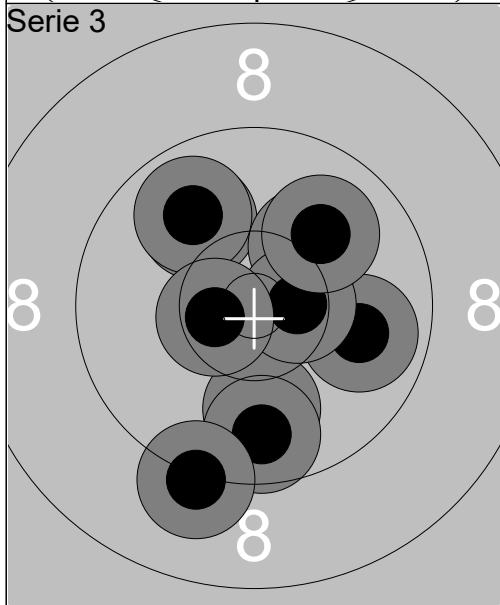

1:	10.0	↓
2:	10.0	↖
3:	9.9	→
4:	10.2	↖
5:	10.5x	→
6:	9.9	↖
7:	9.7	↓
8:	9.2	↓
9:	10.6x	←
10:	10.0	↖
Serie		96 (2x)
Total		273 (3x)

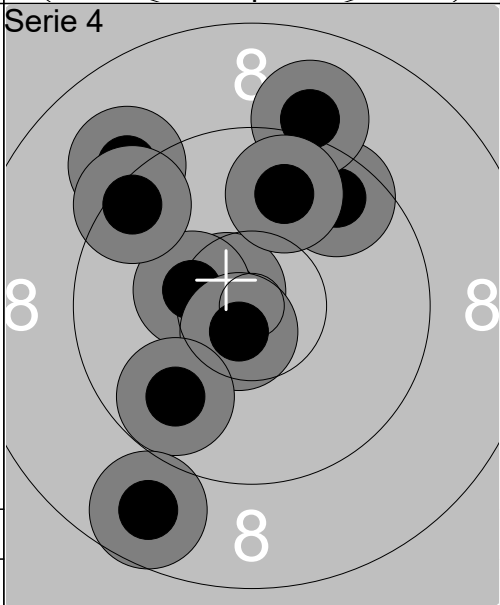

1:	10.7x	↖
2:	10.3	←
3:	9.6	↖
4:	10.7x	↓
5:	9.1	↖
6:	9.1	↖
7:	9.4	↖
8:	9.8	↖
9:	8.7	↓
10:	9.8	↖
Serie		92 (2x)
Total		365 (5x)

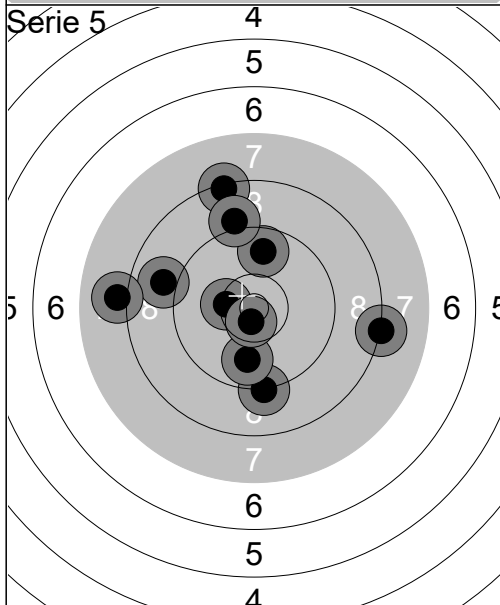

1:	8.9	←
2:	8.2	→
3:	9.7	↖
4:	10.3	←
5:	8.0	←
6:	9.2	↓
7:	8.3	↖
8:	9.8	↓
9:	9.0	↖
10:	10.6x	↓
Serie		88 (1x)
Total		453 (6x)

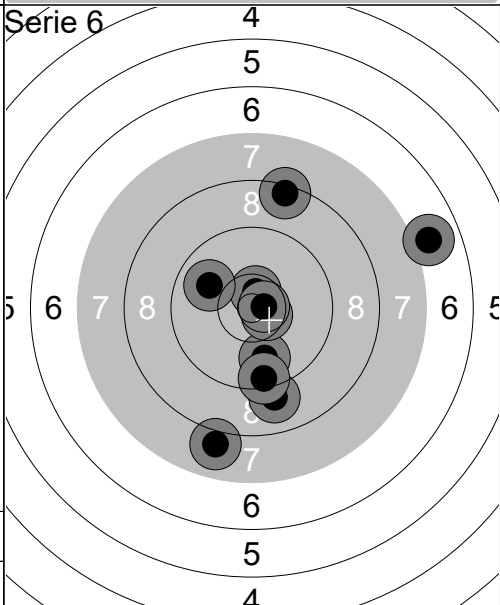

1:	8.4	↖
2:	9.8	↓
3:	9.0	↓
4:	6.9	→
5:	10.6x	→
6:	10.6x	↖
7:	9.9	←
8:	10.7x	→
9:	9.4	↓
10:	7.9	↓
Serie		87 (3x)
Total		540 (9x)

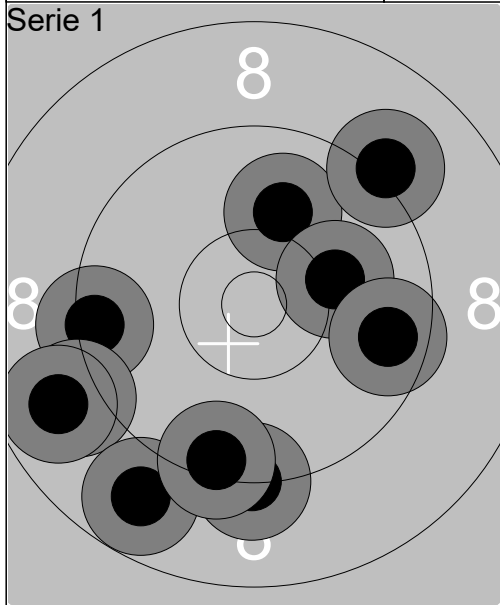

1:	9.4	←
2:	10.0	↑
3:	9.0	←
4:	10.1	→
5:	8.8	←
6:	8.8	↙
7:	9.2	↓
8:	9.4	↓
9:	9.6	→
10:	9.1	↗
Serie		90 (0x)
Total		90 (0x)

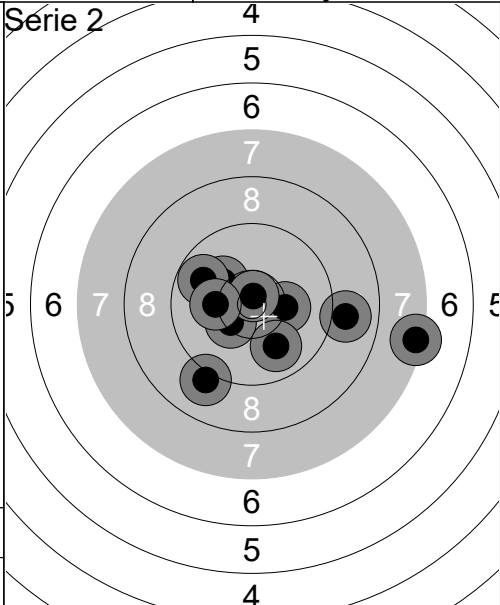

1:	10.2	→
2:	10.4	↙
3:	10.2	↖
4:	9.9	↘
5:	9.1	↘
6:	9.8	↖
7:	7.4	→
8:	8.9	→
9:	10.8x	↑
10:	10.2	←
Serie		92 (1x)
Total		182 (1x)

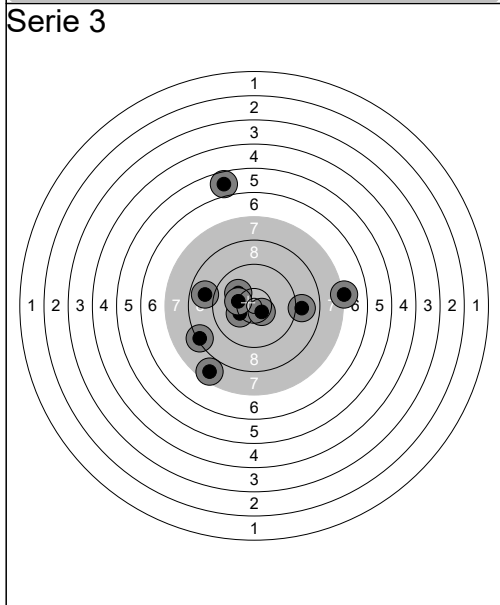

1:	10.3	←
2:	5.7	↑
3:	9.0	→
4:	7.2	→
5:	7.6	↘
6:	8.8	←
7:	8.3	←
8:	10.5x	↘
9:	10.1	↗
10:	10.3	←
Serie		84 (1x)
Total		266 (2x)

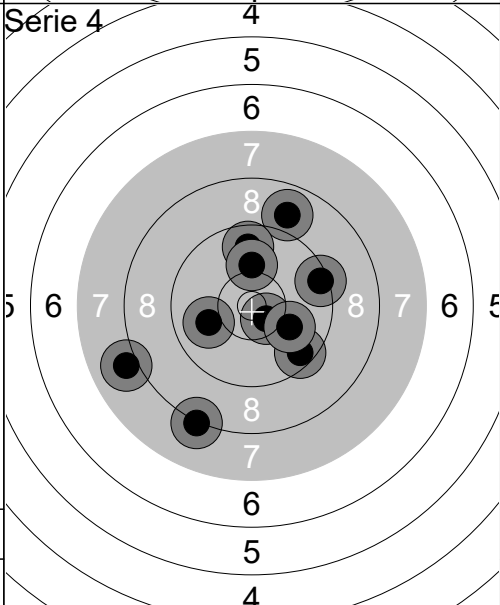

1:	10.5x	↘
2:	8.9	↑
3:	9.5	↘
4:	9.7	↑
5:	8.2	↘
6:	9.4	→
7:	10.1	↑
8:	10.0	↘
9:	10.0	←
10:	8.0	←
Serie		91 (1x)
Total		357 (3x)

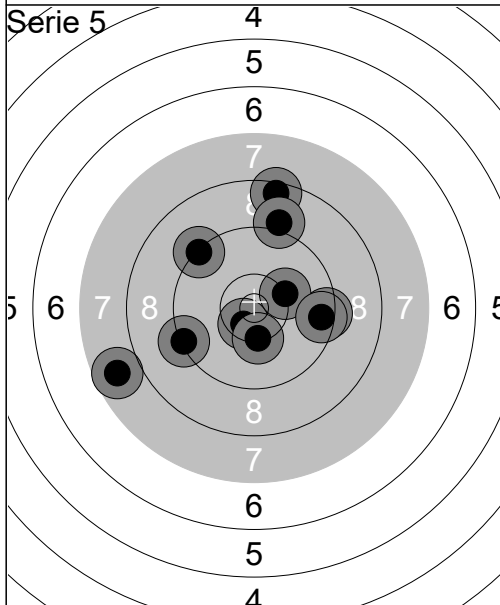

1:	9.4	→
2:	8.5	↑
3:	10.5x	↙
4:	9.3	↖
5:	9.3	←
6:	10.3	↓
7:	10.2	→
8:	9.0	↑
9:	7.7	←
10:	9.5	→
Serie		90 (1x)
Total		447 (4x)

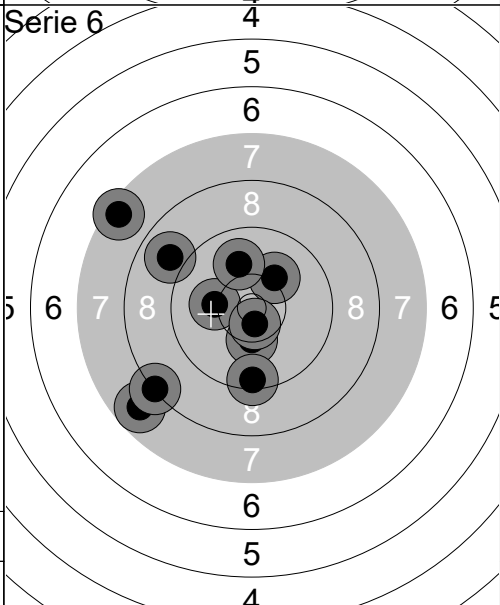

1:	8.9	↖
2:	10.2	←
3:	10.1	↗
4:	10.3	↓
5:	9.4	↓
6:	7.5	↖
7:	10.6x	↓
8:	10.0	↑
9:	7.8	↙
10:	8.3	↙
Serie		89 (1x)
Total		536 (5x)

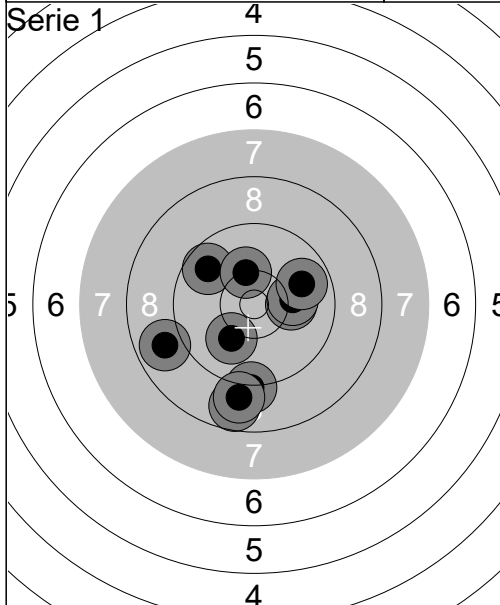

1:	8.8	↙
2:	9.7	↖
3:	9.2	↓
4:	10.2	→
5:	8.7	↓
6:	10.1	→
7:	8.9	↓
8:	10.1	↙
9:	10.2	↑
10:	9.8	↗
Serie		91 (0x)
Total		91 (0x)

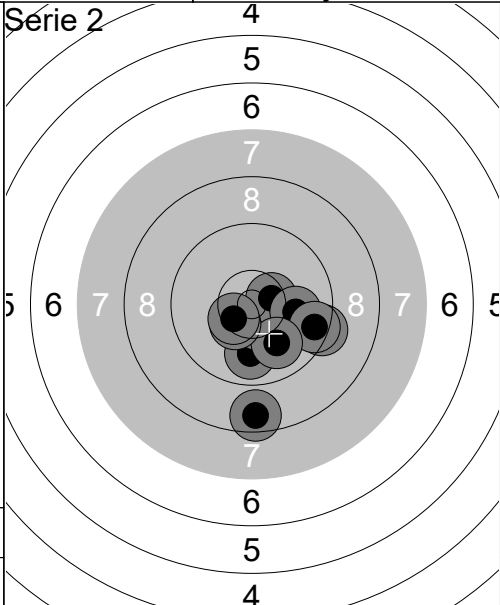

1:	9.9	↓
2:	9.3	↗
3:	10.5x	↓
4:	10.5x	→
5:	10.0	→
6:	9.5	↗
7:	10.0	↓
8:	10.4x	↙
9:	8.6	↓
10:	10.5x	↙
Serie		95 (4x)
Total		186 (4x)

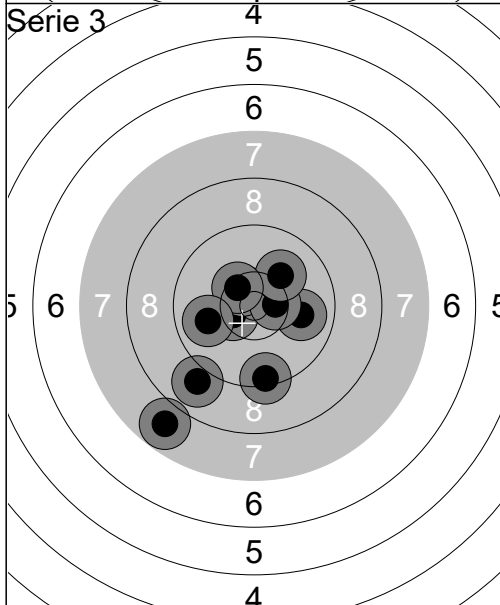

1:	10.5x	↙
2:	9.9	→
3:	10.5x	↖
4:	10.5x	→
5:	10.1	↗
6:	9.4	↓
7:	10.4x	↖
8:	9.9	↙
9:	8.9	↙
10:	7.8	↙
Serie		92 (4x)
Total		278 (8x)

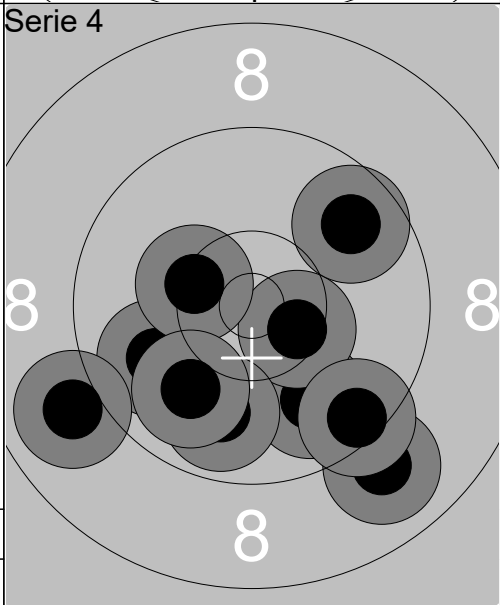

1:	9.9	↙
2:	9.9	↓
3:	9.0	↓
4:	10.5x	↗
5:	9.7	↗
6:	9.5	↓
7:	9.0	↙
8:	9.9	↓
9:	10.3	↖
10:	9.9	↓
Serie		92 (1x)
Total		370 (9x)

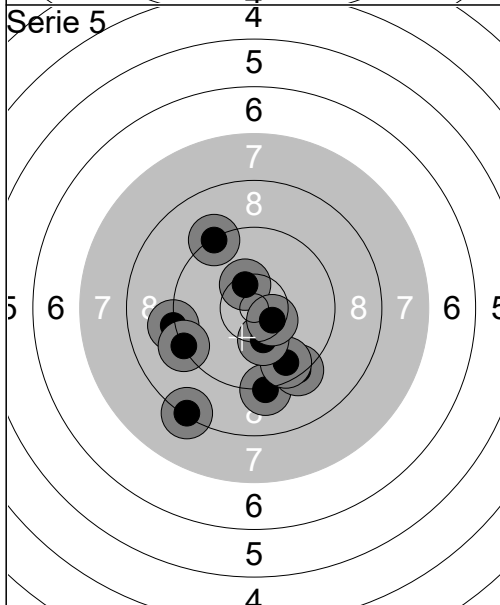

1:	9.2	↓
2:	9.3	↓
3:	10.4x	↑
4:	8.3	↙
5:	9.3	↗
6:	9.6	↓
7:	10.2	↓
8:	10.5x	↗
9:	9.2	↙
10:	9.2	↙
Serie		92 (2x)
Total		462 (11x)

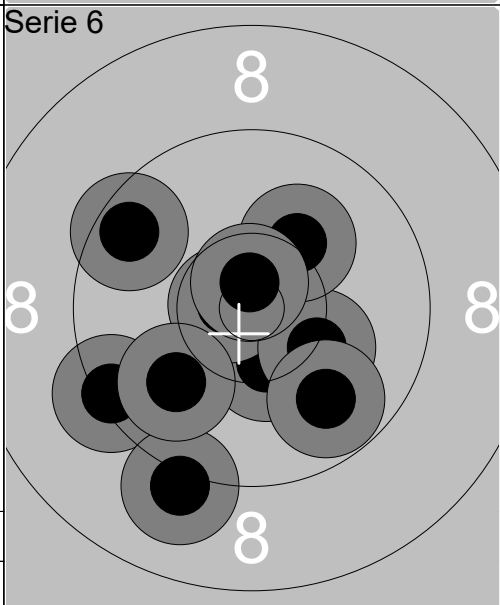

1:	9.4	↙
2:	10.4x	↓
3:	10.7x	↙
4:	9.1	↓
5:	9.6	↖
6:	10.2	↗
7:	10.2	↗
8:	9.8	↓
9:	10.7x	↑
10:	9.9	↙
Serie		95 (3x)
Total		557 (14x)

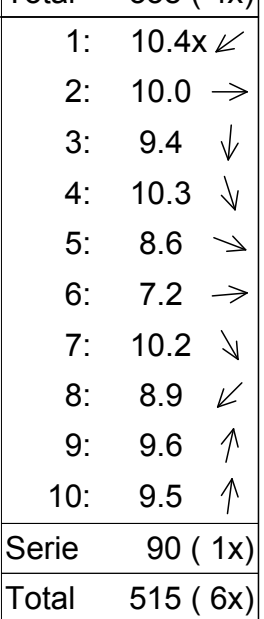
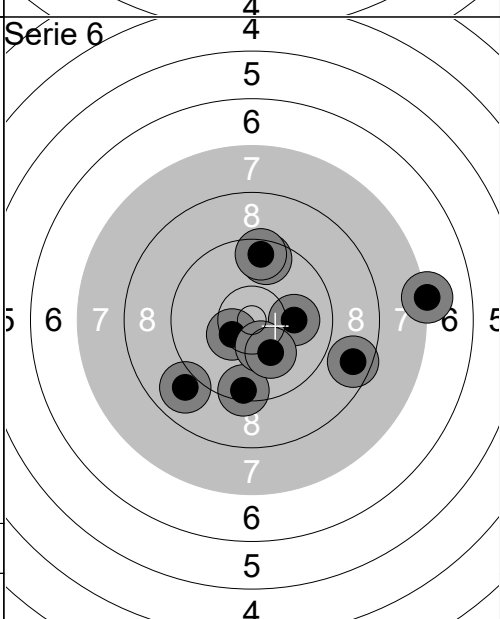
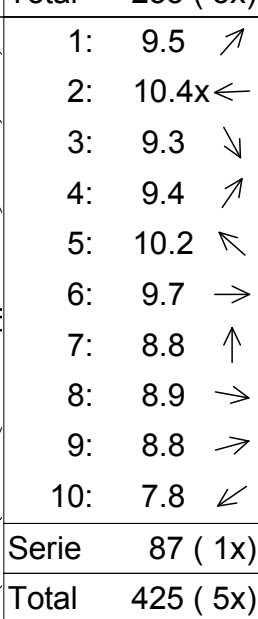
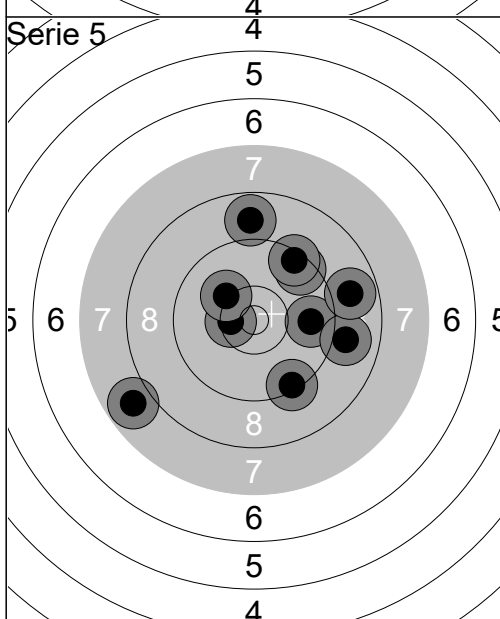
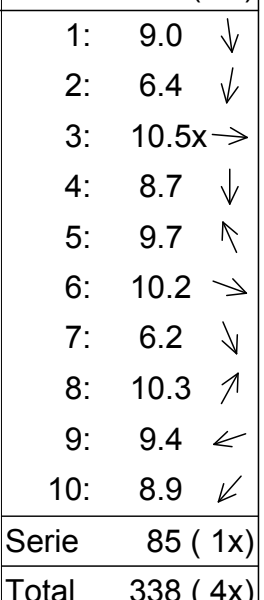
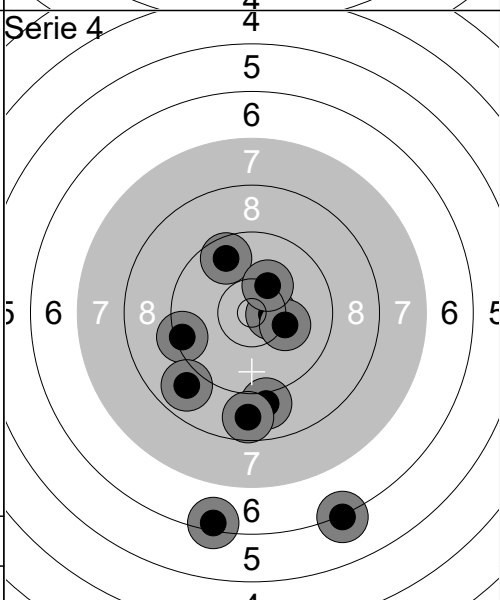
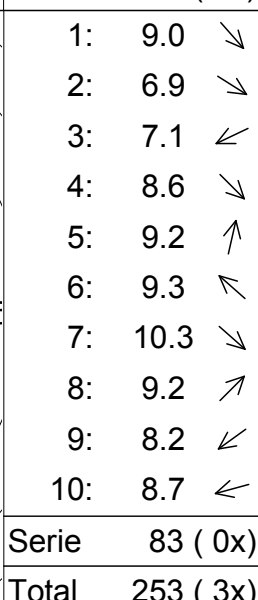
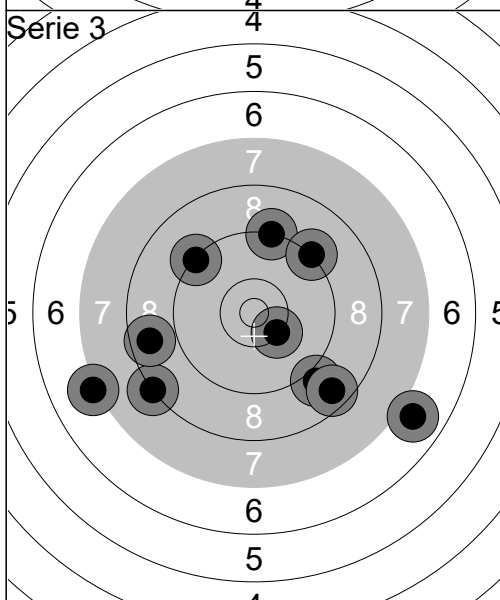
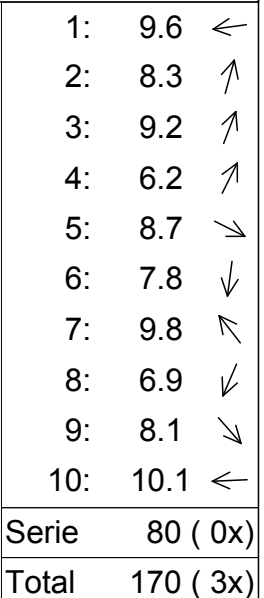
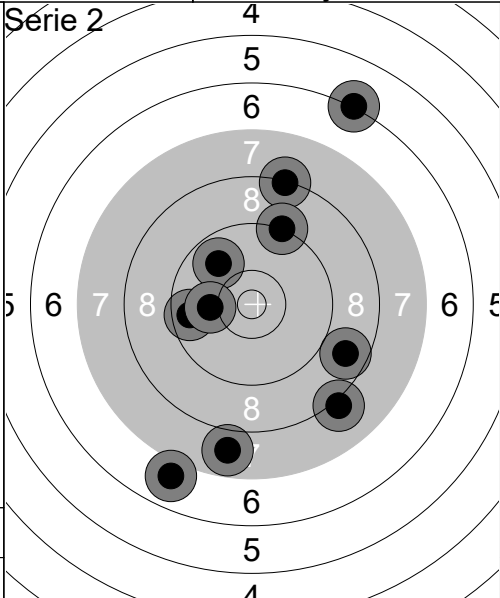
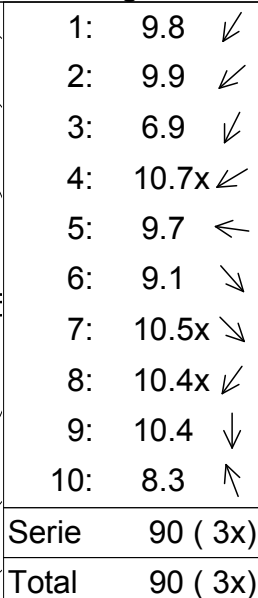
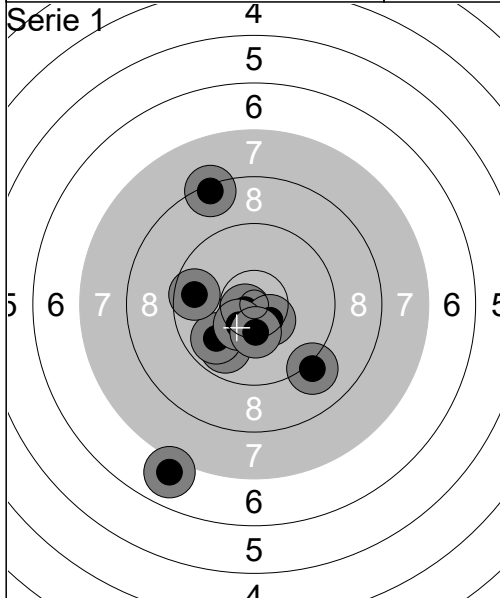

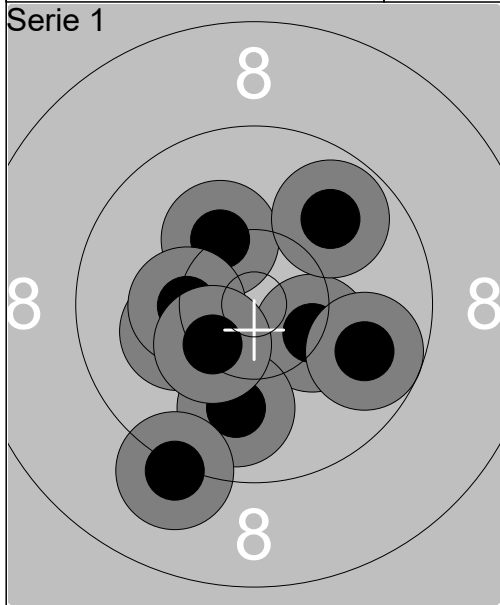

1:	10.3	↓
2:	10.2	↗
3:	10.3	→
4:	9.9	↓
5:	9.8	↗
6:	10.2	←
7:	10.3	←
8:	9.2	↓
9:	9.8	→
10:	10.4x	↙
Serie		96 (1x)
Total		96 (1x)

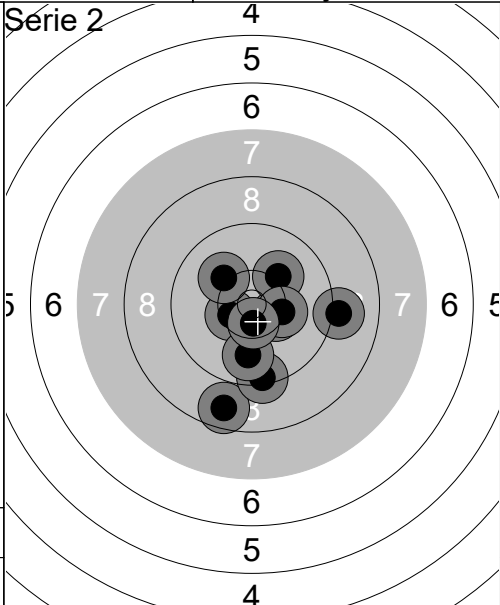

1:	8.7	↓
2:	10.4x	→
3:	10.1	↗
4:	10.4x	↙
5:	9.4	↓
6:	9.1	→
7:	9.9	↓
8:	10.3	→
9:	10.1	↗
10:	10.5x	↓
Serie		95 (3x)
Total		191 (4x)

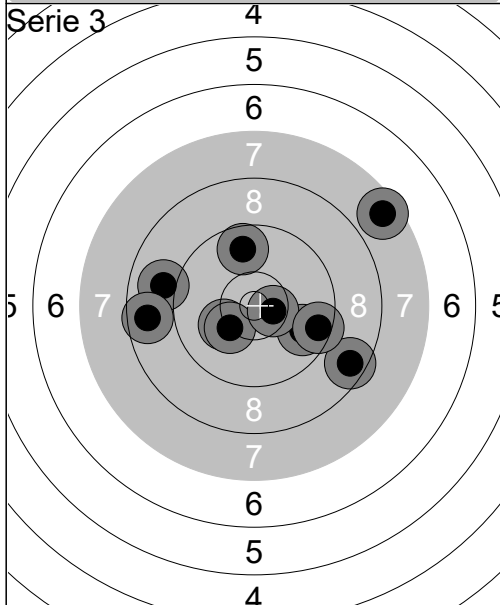

1:	9.8	→
2:	9.7	↑
3:	9.0	←
4:	8.6	↘
5:	10.2	↙
6:	10.3	↙
7:	10.5x	→
8:	8.7	←
9:	7.6	↗
10:	9.5	→
Serie		89 (1x)
Total		280 (5x)

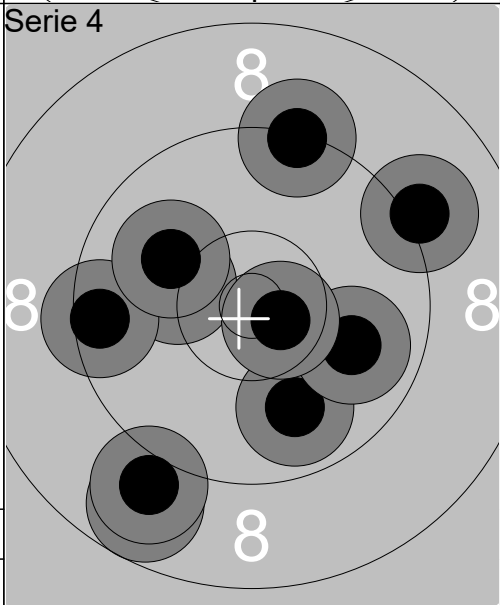

1:	9.1	↗
2:	8.8	↓
3:	9.9	↓
4:	10.2	←
5:	9.9	→
6:	9.5	←
7:	9.0	↓
8:	9.3	↑
9:	10.0	↙
10:	10.6x	→
Serie		92 (1x)
Total		372 (6x)

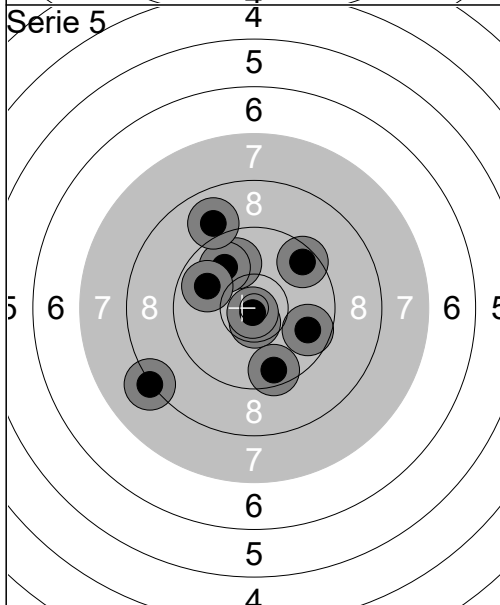

1:	9.9	↗
2:	10.6x	↓
3:	9.9	↗
4:	10.8x	↓
5:	8.2	↙
6:	9.7	→
7:	9.6	↓
8:	9.8	↙
9:	8.9	↗
10:	9.5	↗
Serie		90 (2x)
Total		462 (8x)

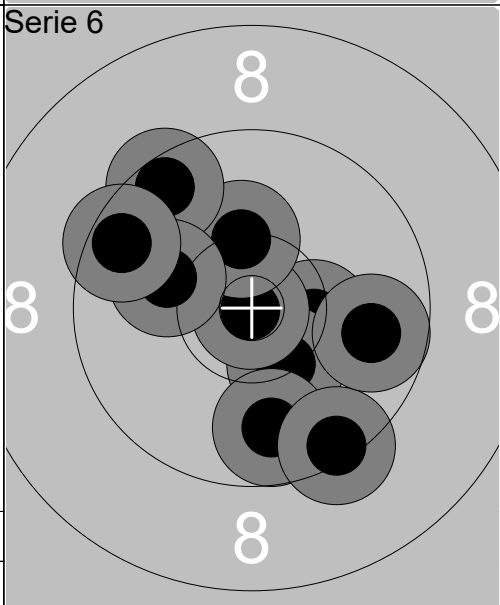

1:	10.3	→
2:	10.3	↓
3:	10.9x	↙
4:	9.8	↓
5:	9.4	↓
6:	10.3	↑
7:	9.5	↗
8:	10.1	←
9:	9.5	↗
10:	9.8	→
Serie		95 (1x)
Total		557 (9x)

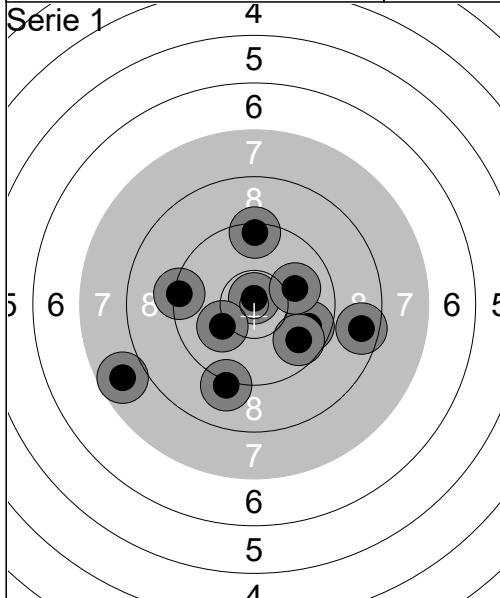

1:	9.7	→
2:	10.8x	↑
3:	8.6	→
4:	9.7	↘
5:	10.0	→
6:	10.1	↙
7:	9.3	←
8:	7.7	↙
9:	9.4	↑
10:	9.1	↓
Serie		90 (1x)
Total		90 (1x)

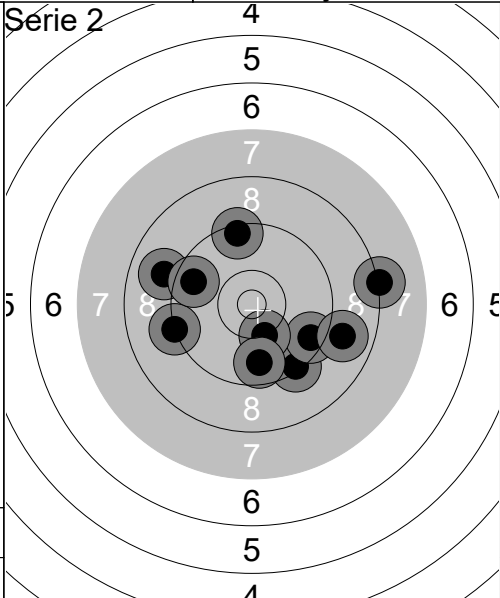

1:	9.0	↙
2:	8.2	→
3:	9.2	↙
4:	9.4	↑
5:	9.3	↘
6:	9.5	↘
7:	9.6	↗
8:	8.9	→
9:	10.2	↓
10:	9.7	↓
Serie		89 (0x)
Total		179 (1x)

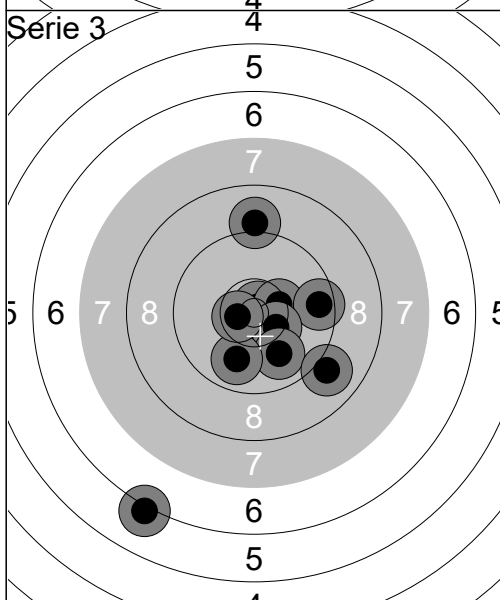

1:	10.8x	↗
2:	10.4x	→
3:	6.1	↘
4:	9.6	→
5:	9.0	↑
6:	10.4x	↘
7:	9.9	↘
8:	9.9	↘
9:	9.0	↘
10:	10.6x	←
Serie		91 (4x)
Total		270 (5x)

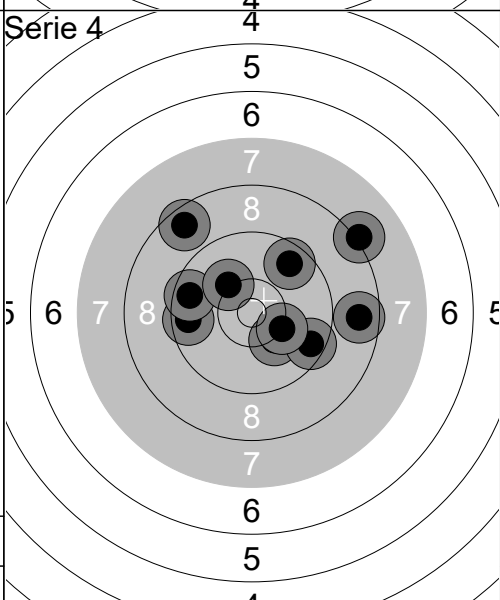

1:	9.6	←
2:	9.6	←
3:	10.2	↘
4:	10.2	↗
5:	8.7	→
6:	9.5	↘
7:	8.6	↗
8:	10.2	↘
9:	9.6	↗
10:	8.2	↗
Serie		90 (0x)
Total		360 (5x)

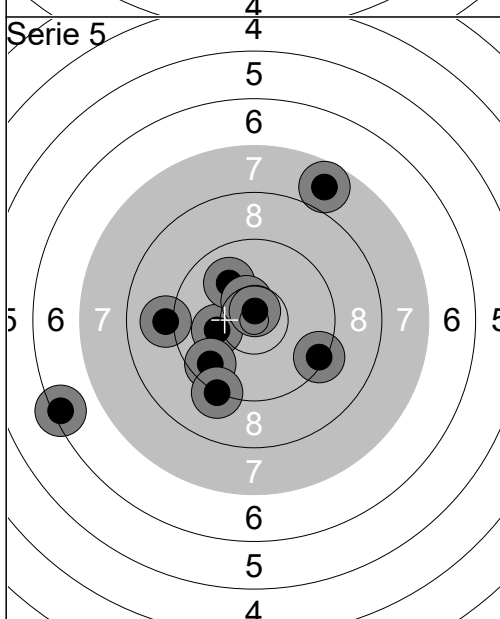

1:	10.1	←
2:	9.6	↙
3:	9.2	↘
4:	10.0	↖
5:	7.7	↗
6:	10.5x	↗
7:	9.1	←
8:	9.3	↘
9:	6.4	←
10:	10.7x	↑
Serie		89 (2x)
Total		449 (7x)

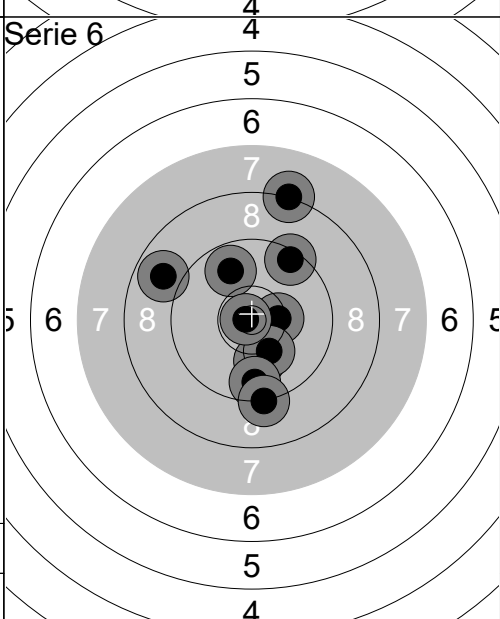

1:	8.2	↑
2:	9.8	↗
3:	10.4x	→
4:	10.1	↓
5:	10.2	↘
6:	8.8	↙
7:	9.4	↗
8:	9.6	↓
9:	9.2	↓
10:	10.8x	←
Serie		92 (2x)
Total		541 (9x)

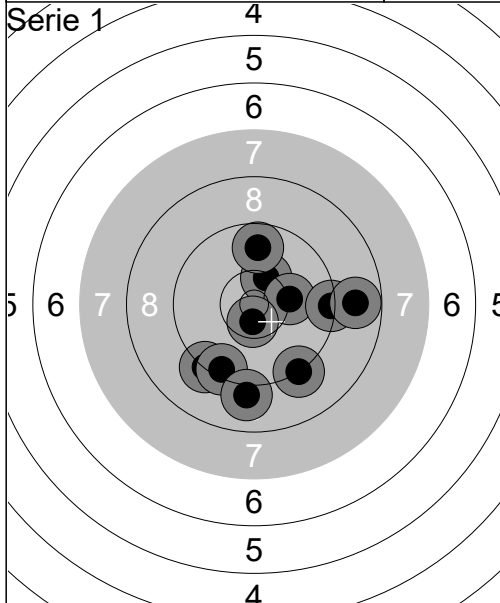

1:	10.3	↗
2:	9.2	↘
3:	10.2	→
4:	10.6x	↓
5:	9.3	→
6:	9.4	↘
7:	9.0	↓
8:	9.7	↑
9:	8.8	→
10:	9.2	↘
Serie		92 (1x)
Total		92 (1x)

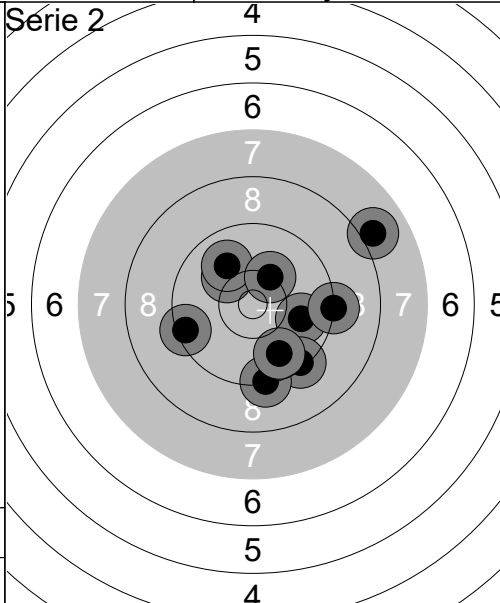

1:	10.1	↗
2:	9.9	→
3:	9.3	↘
4:	10.0	↗
5:	8.0	↗
6:	9.4	←
7:	9.3	↓
8:	9.2	→
9:	10.3	↗
10:	9.8	↘
Serie		92 (0x)
Total		184 (1x)

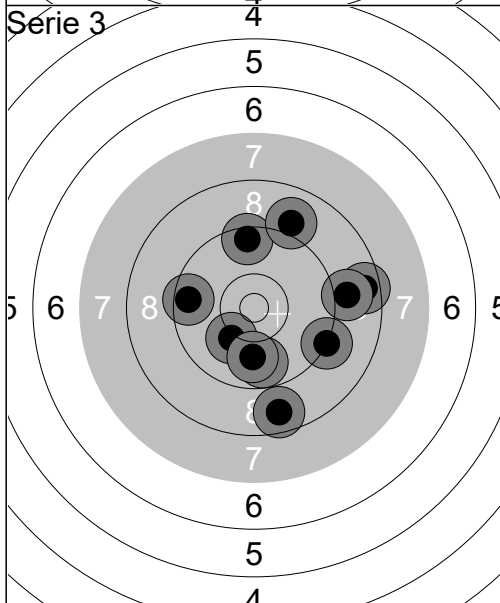

1:	9.5	←
2:	9.8	↓
3:	10.1	↘
4:	8.7	↓
5:	9.9	↓
6:	9.5	↑
7:	9.2	→
8:	9.0	↑
9:	8.6	→
10:	8.9	→
Serie		88 (0x)
Total		272 (1x)

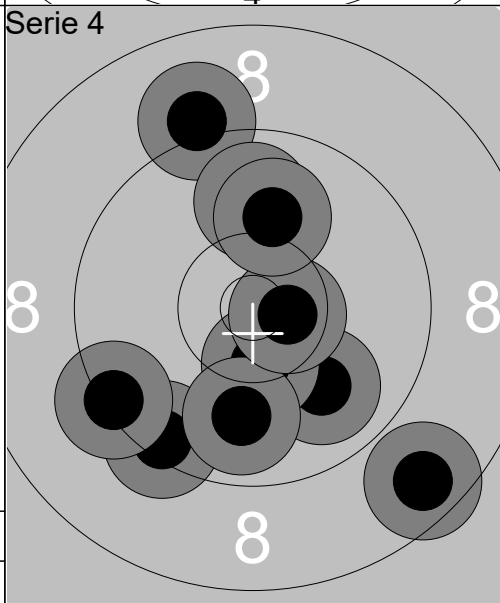

1:	9.4	↘
2:	9.9	↘
3:	9.3	↘
4:	9.1	↑
5:	10.4x	↓
6:	9.9	↑
7:	9.9	↓
8:	8.6	↘
9:	10.6x	→
10:	10.0	↑
Serie		92 (2x)
Total		364 (3x)

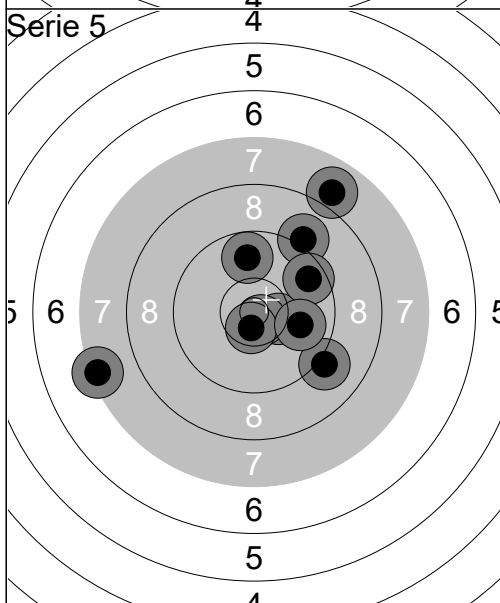

1:	9.1	↘
2:	10.4x	→
3:	7.4	←
4:	10.7x	↘
5:	9.8	↑
6:	9.1	↗
7:	10.6x	↓
8:	9.6	↗
9:	9.9	→
10:	7.9	↗
Serie		89 (3x)
Total		453 (6x)

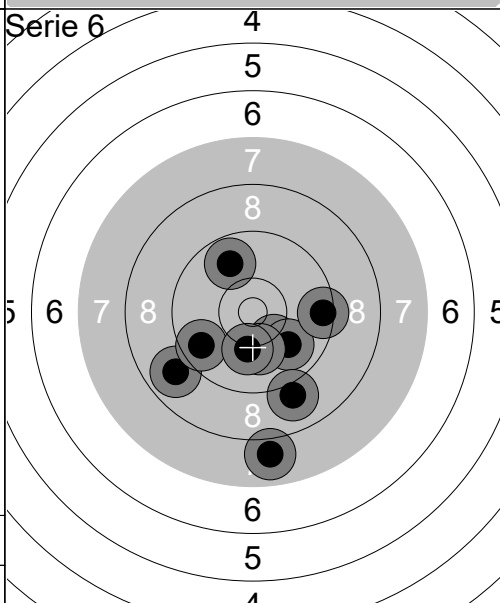

1:	8.9	↘
2:	9.6	↘
3:	7.9	↓
4:	10.2	↘
5:	9.9	↘
6:	9.8	↗
7:	9.0	↓
8:	9.5	→
9:	10.1	↓
10:	10.1	↓
Serie		90 (0x)
Total		543 (6x)

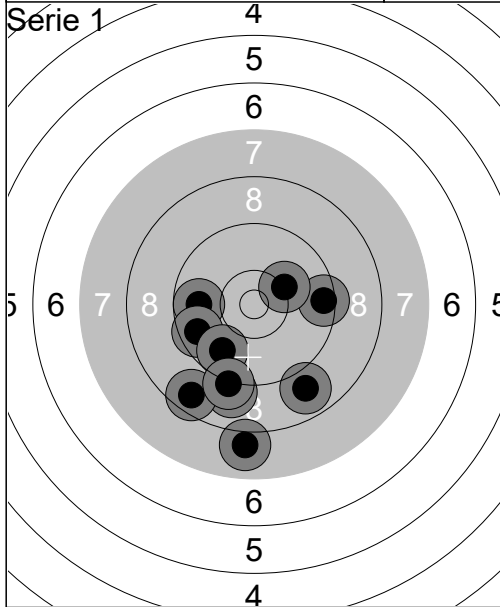

1:	7.9	↓
2:	9.0	↓
3:	9.8	←
4:	9.5	→
5:	8.9	↓
6:	9.6	←
7:	8.6	↓
8:	9.8	↓
9:	9.2	↓
10:	10.2	↗
Serie		87 (0x)
Total		87 (0x)

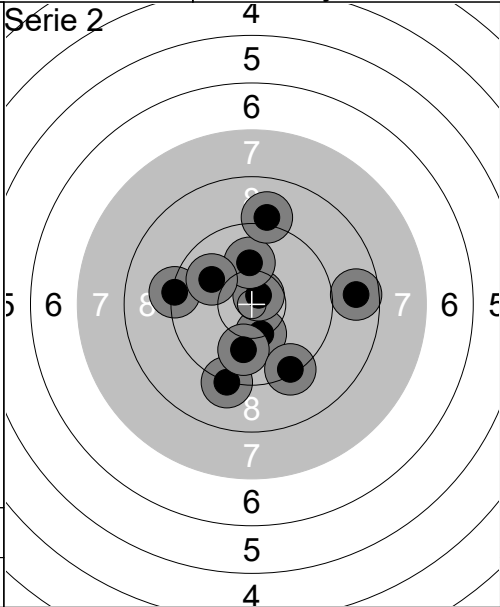

1:	10.3	↓
2:	9.2	↓
3:	10.0	↓
4:	10.7x	↗
5:	8.7	→
6:	9.3	↓
7:	10.1	↑
8:	9.3	←
9:	9.1	↑
10:	9.9	↖
Serie		93 (1x)
Total		180 (1x)

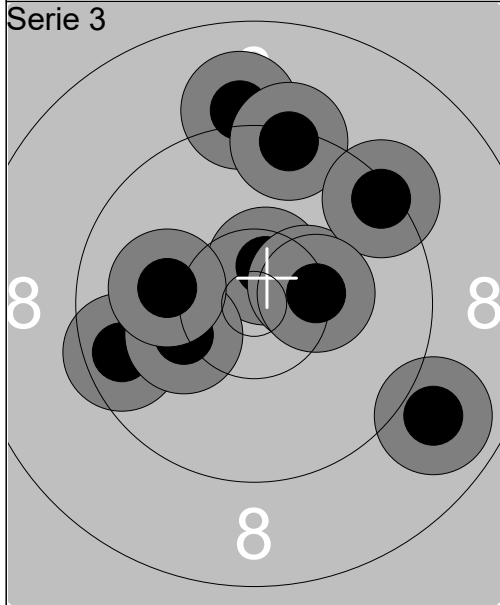

1:	10.6x	↑
2:	9.1	↑
3:	9.3	↑
4:	9.6	←
5:	8.9	↘
6:	10.2	←
7:	10.4x	→
8:	9.4	↗
9:	10.1	←
10:	10.3	→
Serie		94 (2x)
Total		274 (3x)

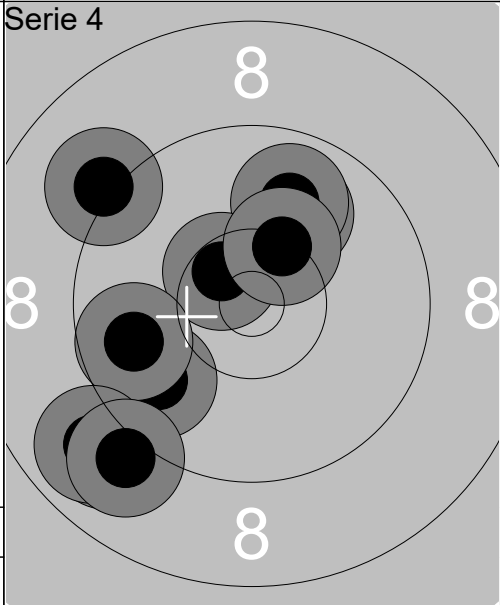

1:	10.0	↑
2:	9.1	↖
3:	9.9	↑
4:	9.8	←
5:	10.5x	↖
6:	9.0	↓
7:	9.8	←
8:	10.3	↑
9:	8.9	↓
10:	9.0	↓
Serie		92 (1x)
Total		366 (4x)

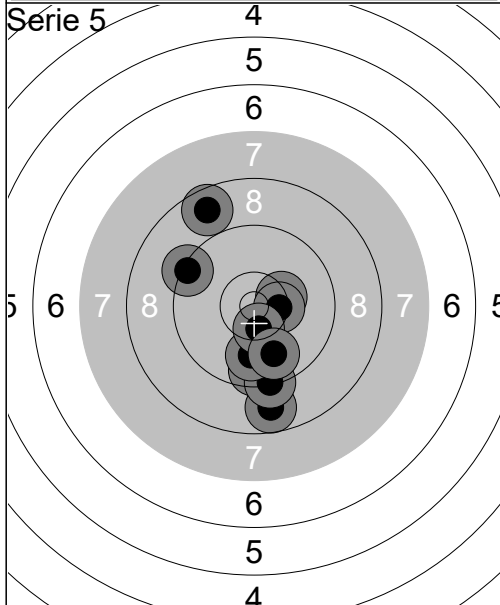

1:	9.6	↓
2:	10.3	→
3:	8.8	↓
4:	10.4x	→
5:	8.7	↗
6:	9.3	↓
7:	9.9	↓
8:	9.3	↖
9:	10.5x	↓
10:	9.8	↓
Serie		91 (2x)
Total		457 (6x)

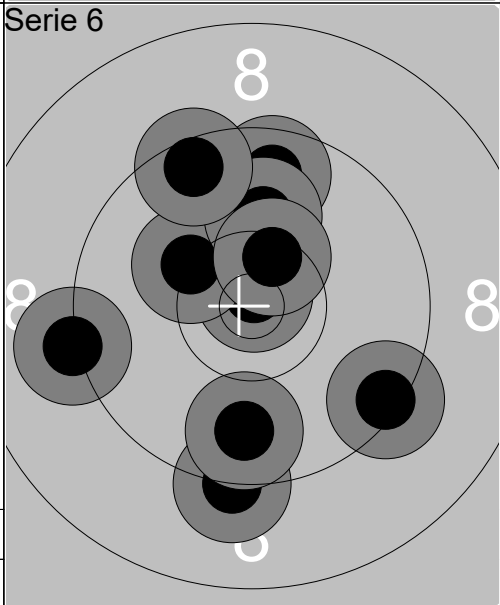

1:	9.2	←
2:	10.8x	↑
3:	9.2	↓
4:	10.2	↖
5:	9.7	↑
6:	9.7	↓
7:	10.1	↑
8:	10.4x	↗
9:	9.4	↘
10:	9.5	↗
Serie		94 (2x)
Total		551 (8x)

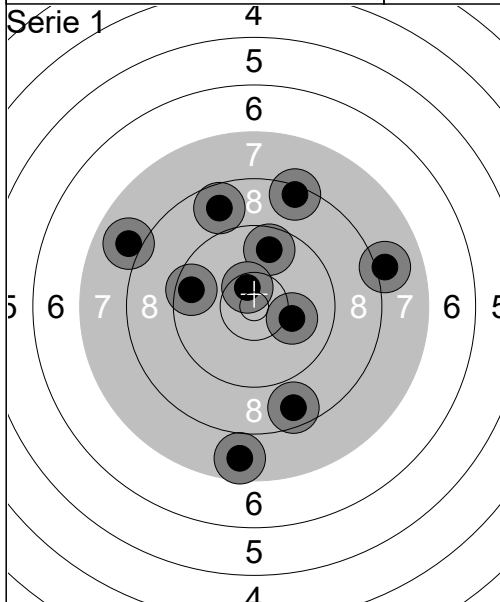

1:	8.7	↑
2:	10.1	→
3:	8.4	↑
4:	9.7	↑
5:	8.0	←
6:	8.0	→
7:	10.5x	↑
8:	9.6	←
9:	7.7	↓
10:	8.6	↓
Serie	85 (1x)	
Total	85 (1x)	

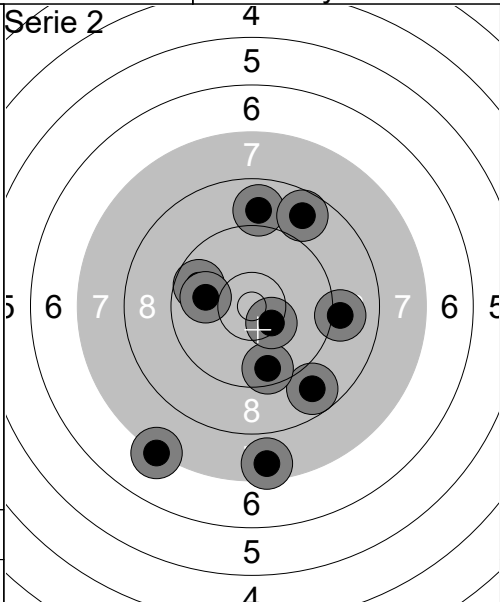

1:	8.9	↑
2:	7.6	↓
3:	8.7	↑
4:	9.1	→
5:	9.7	←
6:	8.8	↓
7:	9.6	↓
8:	7.2	↓
9:	10.4x	↘
10:	9.9	←
Serie	84 (1x)	
Total	169 (2x)	

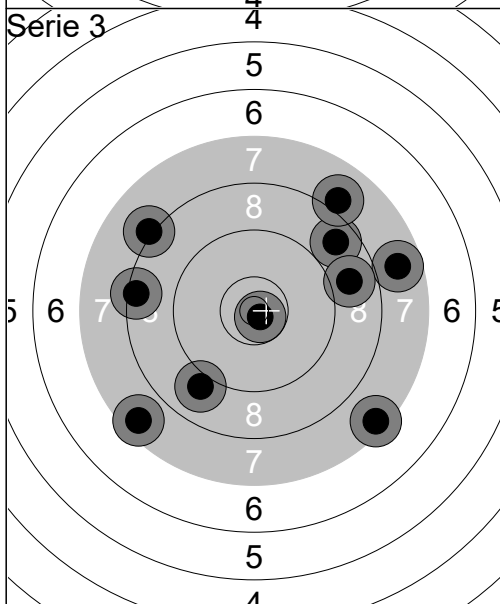

1:	8.7	↗
2:	7.7	→
3:	7.6	↙
4:	8.8	→
5:	8.4	←
6:	9.0	↙
7:	8.1	↗
8:	8.0	↗
9:	10.8x	↘
10:	7.5	↘
Serie	80 (1x)	
Total	249 (3x)	

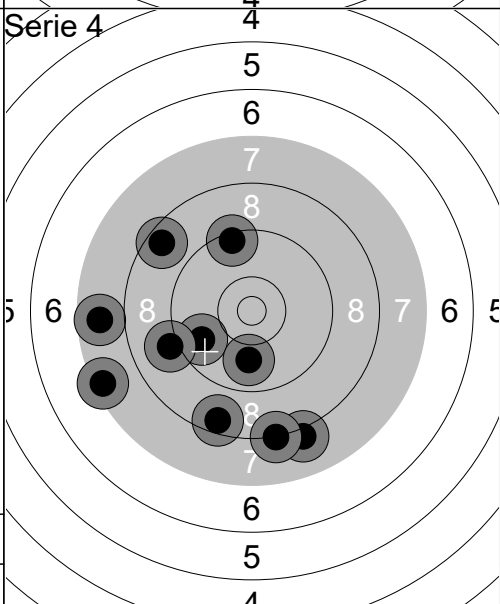

1:	8.5	↓
2:	9.7	↙
3:	9.1	↙
4:	9.4	↑
5:	8.1	↓
6:	8.2	↓
7:	7.7	←
8:	9.9	↓
9:	8.5	↖
10:	7.4	↙
Serie	82 (0x)	
Total	331 (3x)	

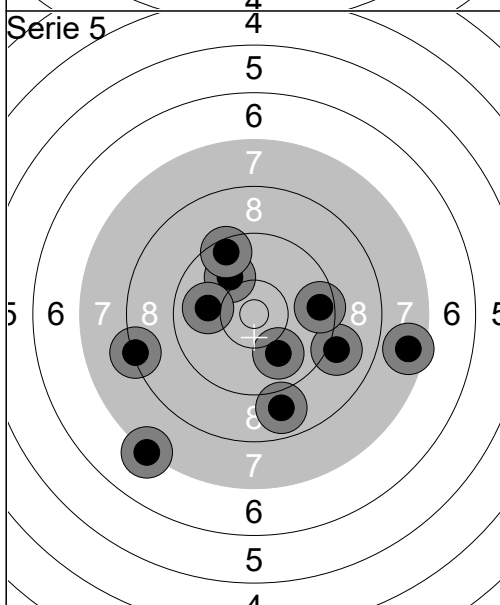

1:	9.0	→
2:	10.0	↗
3:	9.5	↑
4:	8.3	←
5:	7.2	↙
6:	10.0	↙
7:	9.5	→
8:	9.9	←
9:	7.6	→
10:	8.9	↓
Serie	86 (0x)	
Total	417 (3x)	

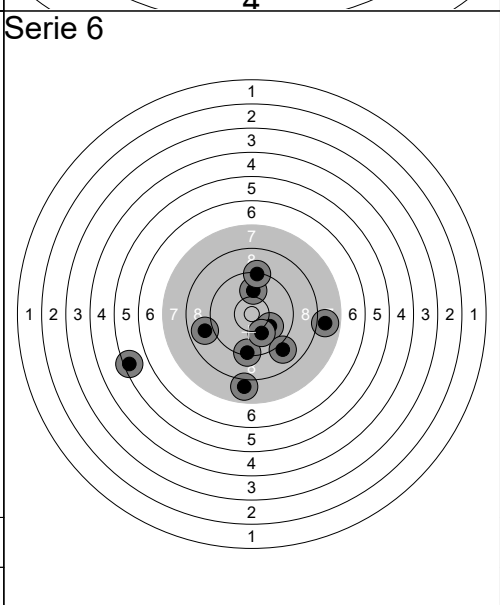

1:	7.9	→
2:	10.0	↑
3:	9.3	↓
4:	5.4	←
5:	7.9	↓
6:	10.0	↘
7:	9.0	↘
8:	9.3	↑
9:	10.0	↓
10:	8.9	←
Serie	84 (0x)	
Total	501 (3x)	

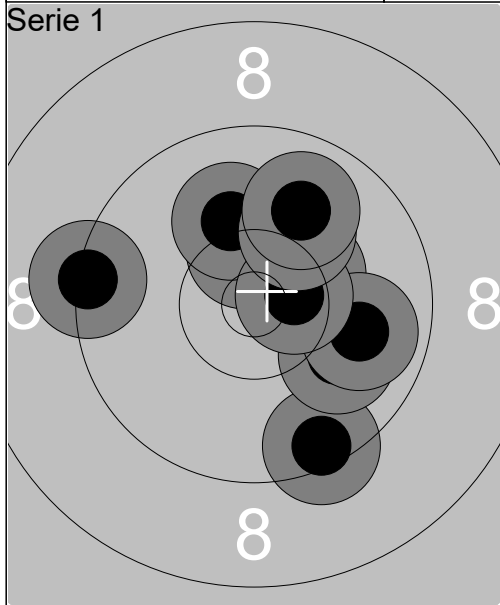

1:	9.4	↘
2:	10.4x	↗
3:	10.4x	↑
4:	9.3	←
5:	10.0	↘
6:	9.9	→
7:	10.1	↑
8:	10.6x	→
9:	10.1	↗
10:	9.9	↗
Serie		96 (3x)
Total		96 (3x)

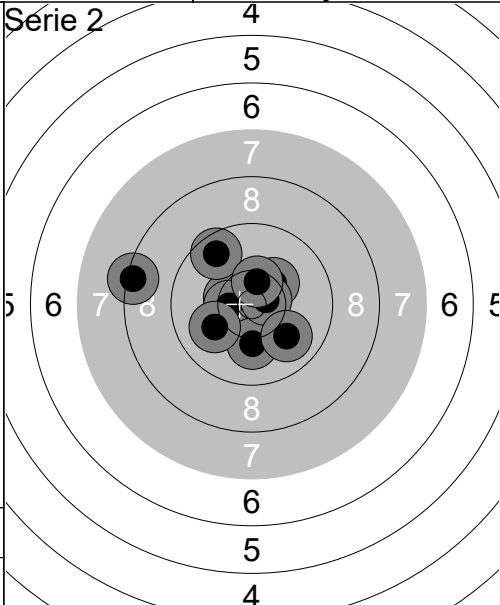

1:	10.4x	←
2:	10.5x	←
3:	8.4	←
4:	9.6	↗
5:	10.1	↓
6:	10.3	↗
7:	10.0	↙
8:	10.6x	→
9:	10.4x	↑
10:	9.9	↘
Serie		96 (4x)
Total		192 (7x)

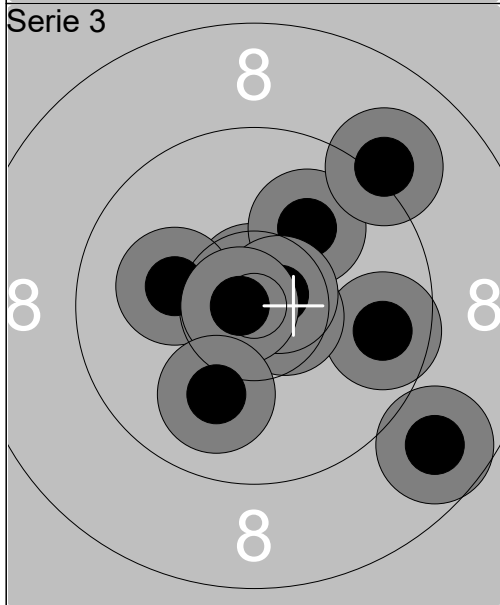

1:	10.7x	↑
2:	9.7	→
3:	8.7	↘
4:	10.6x	→
5:	10.0	↗
6:	10.7x	↗
7:	10.2	←
8:	9.1	↗
9:	10.8x	←
10:	10.0	↓
Serie		96 (4x)
Total		288 (11x)

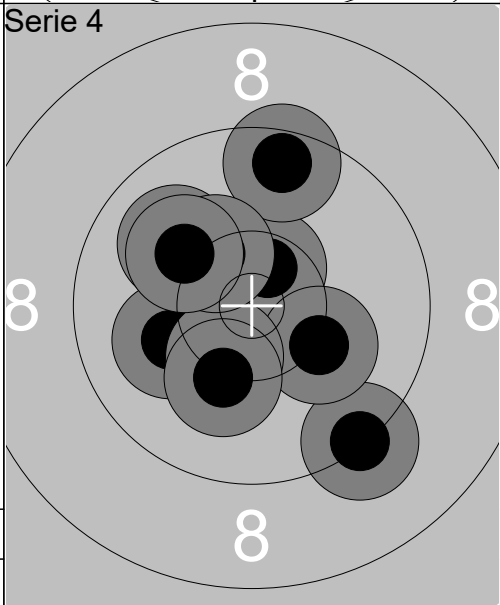

1:	10.1	←
2:	10.6x	↑
3:	9.3	↘
4:	10.2	↘
5:	10.0	↖
6:	10.4x	↘
7:	9.5	↑
8:	10.3	↖
9:	10.2	↓
10:	10.1	↖
Serie		98 (2x)
Total		386 (13x)

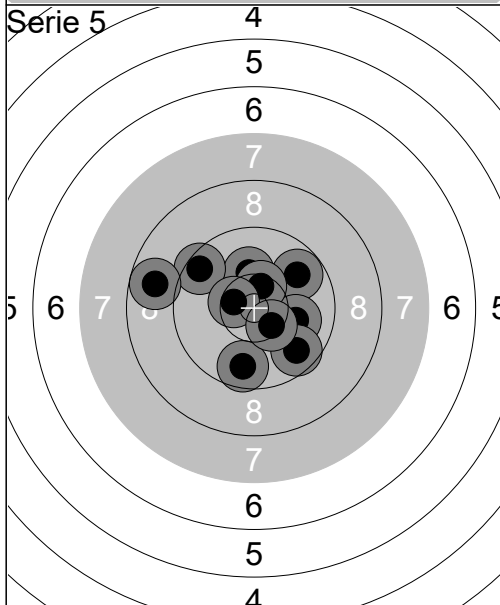

1:	10.2	↑
2:	9.5	↖
3:	9.7	↓
4:	9.8	↗
5:	10.0	→
6:	10.5x	↑
7:	8.8	←
8:	10.5x	←
9:	9.7	↘
10:	10.4x	↘
Serie		94 (3x)
Total		480 (16x)

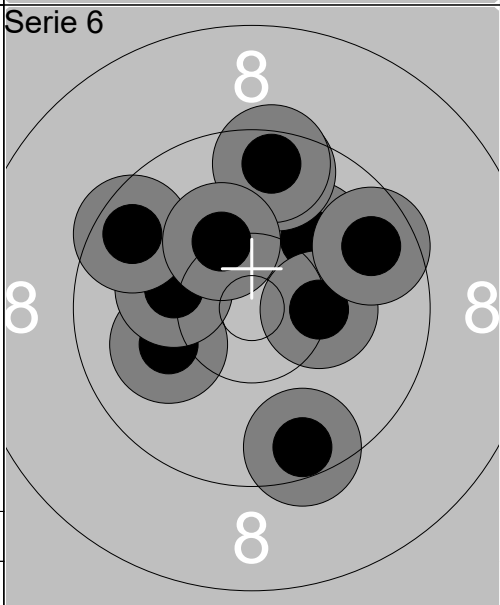

1:	9.5	↓
2:	10.1	↗
3:	9.6	↑
4:	10.3	→
5:	9.5	↑
6:	10.1	←
7:	10.2	←
8:	9.6	↖
9:	9.6	↗
10:	10.2	↗
Serie		95 (0x)
Total		575 (16x)