

Skjutlag	Tavla	Lennart Selander		
1 Luft		Örnsköldsviks Pistolklubb	H/D 55	
21.01.2024	Vinterträffen 2024	Umeå skytteallians		
	1: 7.7 ↑		1: 9.1 →	
	2: 9.7 ↓		2: 10.6x ↓	2: 10.6x ↓
	3: 10.4x ↗		3: 10.2 ↑	3: 10.2 ↑
	4: 9.2 ↙	4: 8.8 ↙	4: 8.8 ↙	
	5: 9.9 ↑	5: 10.6x ↙	5: 10.6x ↙	
	6: 10.3 ↓	6: 10.6x ↑	6: 10.6x ↑	
	7: 9.6 ↑	7: 10.6x →	7: 10.6x →	
	8: 9.5 ↙	8: 10.6x ↙	8: 10.6x ↙	
	9: 10.2 ↙	9: 10.3 ↘	9: 10.3 ↘	
	10: 7.8 ↗	10: 9.5 ↗	10: 9.5 ↗	
Serie 89 (1x)	Serie 96 (5x)	Serie 96 (5x)	Serie 96 (5x)	
Total 89 (1x)	Total 185 (6x)	Total 185 (6x)	Total 185 (6x)	
	1: 9.0 ↑		1: 10.1 ↙	
	2: 8.9 ↙		2: 10.2 ↑	2: 10.2 ↑
	3: 10.1 ↗		3: 10.2 ↗	3: 10.2 ↗
	4: 9.9 ↙	4: 9.4 ↓	4: 9.4 ↓	
	5: 10.6x ↙	5: 9.5 ↑	5: 9.5 ↑	
	6: 10.3 ↑	6: 8.7 ↙	6: 8.7 ↙	
	7: 10.7x ↙	7: 9.1 ↑	7: 9.1 ↑	
	8: 8.9 ↑	8: 9.8 ↑	8: 9.8 ↑	
	9: 10.0 ↙	9: 9.6 ↙	9: 9.6 ↙	
	10: 9.6 ↓	10: 10.6x ↘	10: 10.6x ↘	
Serie 93 (2x)	Serie 93 (1x)	Serie 93 (1x)	Serie 93 (1x)	
Total 278 (8x)	Total 371 (9x)	Total 371 (9x)	Total 371 (9x)	
	1: 9.5 ↙		1: 10.1 →	
	2: 9.7 ↑		2: 8.7 ↑	2: 8.7 ↑
	3: 7.7 ↑		3: 9.1 ↘	3: 9.1 ↘
	4: 9.6 ↑	4: 8.9 ↗	4: 8.9 ↗	
	5: 8.9 ↓	5: 10.0 ↙	5: 10.0 ↙	
	6: 10.2 ↙	6: 9.8 ↑	6: 9.8 ↑	
	7: 8.4 →	7: 10.9x ↑	7: 10.9x ↑	
	8: 9.8 ↓	8: 9.3 ↗	8: 9.3 ↗	
	9: 9.9 ↗	9: 10.5x ↑	9: 10.5x ↑	
	10: 10.0 ↗	10: 8.7 →	10: 8.7 →	
Serie 88 (0x)	Serie 91 (2x)	Serie 91 (2x)	Serie 91 (2x)	
Total 459 (9x)	Total 550 (11x)	Total 550 (11x)	Total 550 (11x)	

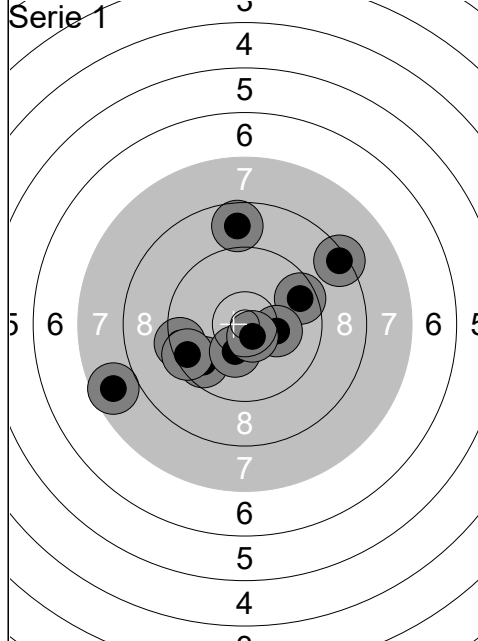

1:	9.6	➔
2:	8.8	↑
3:	9.4	←
4:	7.7	↙
5:	9.7	↘
6:	10.2	➔
7:	9.5	↙
8:	8.4	↗
9:	10.3	↘
10:	10.6x	↘
Serie		89 (1x)
Total		89 (1x)

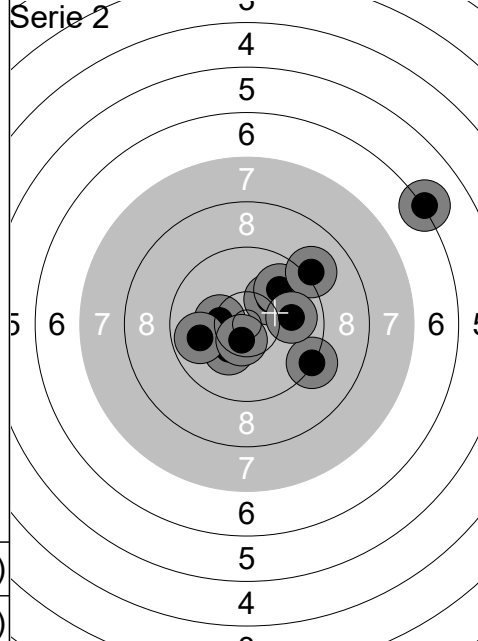

1:	9.3	➔
2:	10.3	↘
3:	10.2	↗
4:	9.9	↗
5:	9.1	↗
6:	10.3	←
7:	9.9	➔
8:	9.8	←
9:	10.6x	↘
10:	6.2	↗
Serie		91 (1x)
Total		180 (2x)

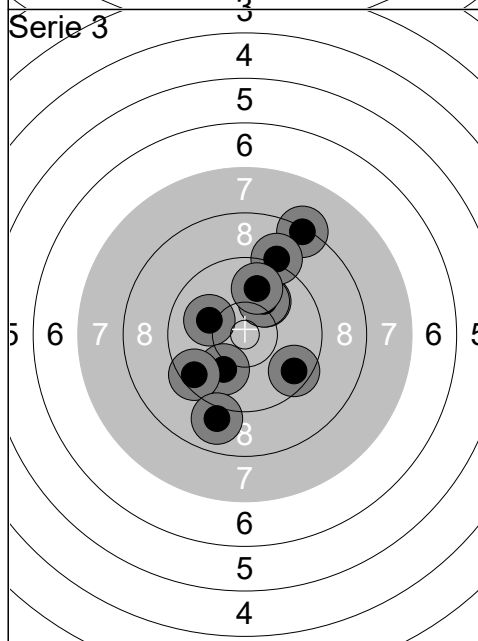

1:	8.3	↗
2:	9.6	↘
3:	10.1	←
4:	10.0	↘
5:	9.5	↙
6:	10.1	↗
7:	9.0	↘
8:	9.1	↗
9:	10.1	↗
10:	9.9	↗
Serie		93 (0x)
Total		273 (2x)

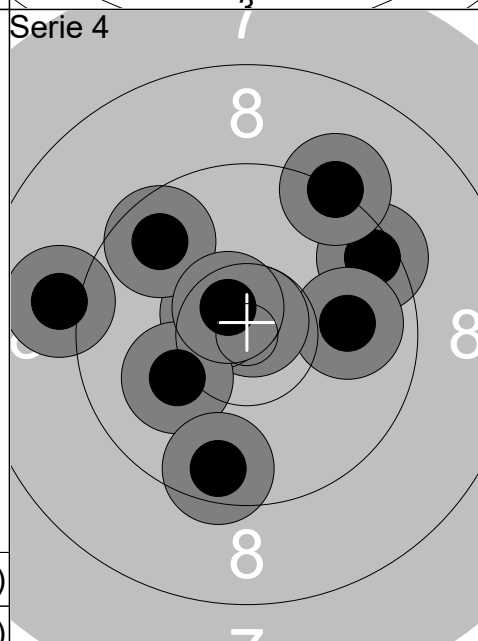

1:	9.5	↗
2:	9.9	➔
3:	9.2	↗
4:	10.8x	↗
5:	10.6x	↙
6:	9.7	↙
7:	10.1	←
8:	9.6	↘
9:	10.6x	↙
10:	9.0	←
Serie		94 (3x)
Total		367 (5x)

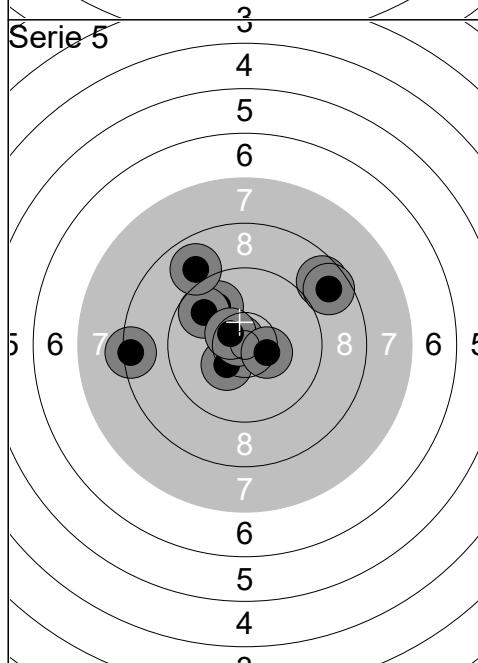

1:	10.3	↘
2:	8.7	↗
3:	10.8x	↙
4:	9.9	↗
5:	8.4	←
6:	9.8	↙
7:	8.9	↗
8:	8.7	↗
9:	10.5x	↙
10:	10.4x	➔
Serie		90 (3x)
Total		457 (8x)

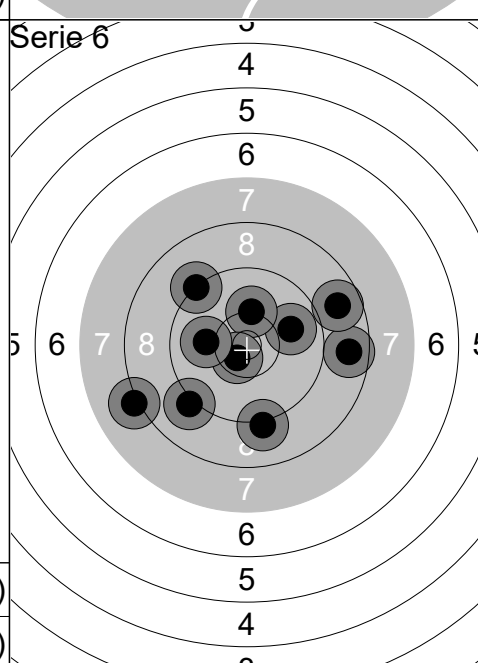

1:	9.9	➔
2:	10.2	↑
3:	8.7	➔
4:	8.1	↙
5:	9.2	↙
6:	9.1	↘
7:	9.1	↘
8:	10.6x	↘
9:	10.0	←
10:	8.7	↗
Serie		90 (1x)
Total		547 (9x)

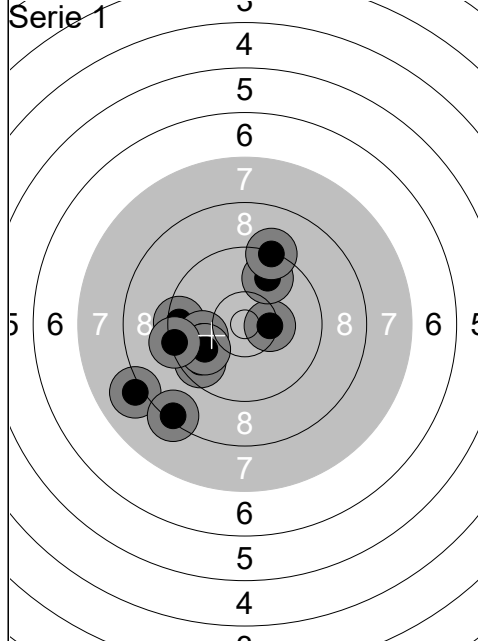

1:	9.5	←
2:	8.1	↙
3:	10.4x	→
4:	9.8	↗
5:	10.0	←
6:	9.3	↗
7:	9.6	↙
8:	9.9	↙
9:	8.3	↙
10:	9.3	←
Serie	90	(1x)
Total	90	(1x)

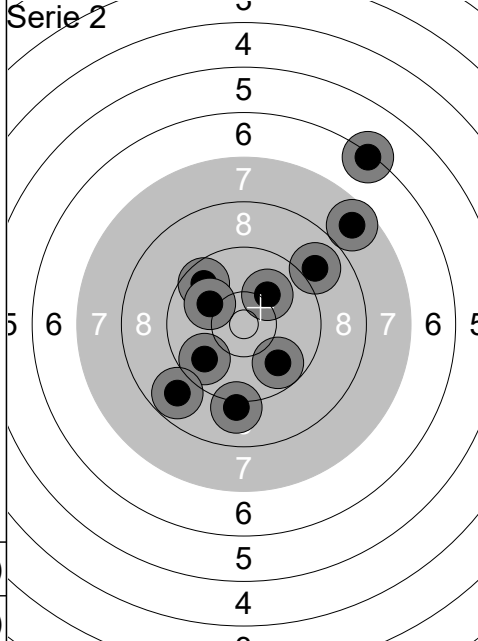

1:	8.9	↗
2:	10.1	↗
3:	6.3	↗
4:	9.1	↓
5:	9.7	↖
6:	9.8	↙
7:	8.8	↙
8:	10.1	↖
9:	7.7	↗
10:	9.8	↘
Serie	85	(0x)
Total	175	(1x)

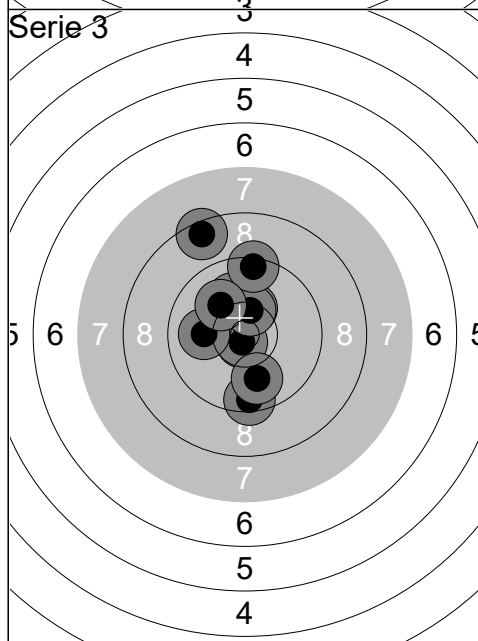

1:	8.5	↗
2:	10.8x	↘
3:	9.5	↓
4:	10.0	←
5:	10.3	↗
6:	10.1	↗
7:	10.4x	↗
8:	9.4	↗
9:	10.1	↖
10:	9.9	↘
Serie	95	(2x)
Total	270	(3x)

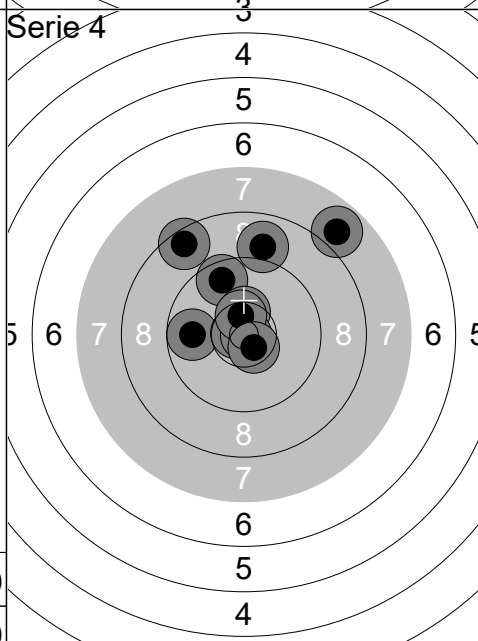

1:	9.8	←
2:	9.6	↗
3:	10.8x	←
4:	10.4x	↗
5:	8.5	↗
6:	10.9x	→
7:	7.9	↗
8:	8.9	↗
9:	10.5x	↗
10:	10.6x	↘
Serie	91	(5x)
Total	361	(8x)

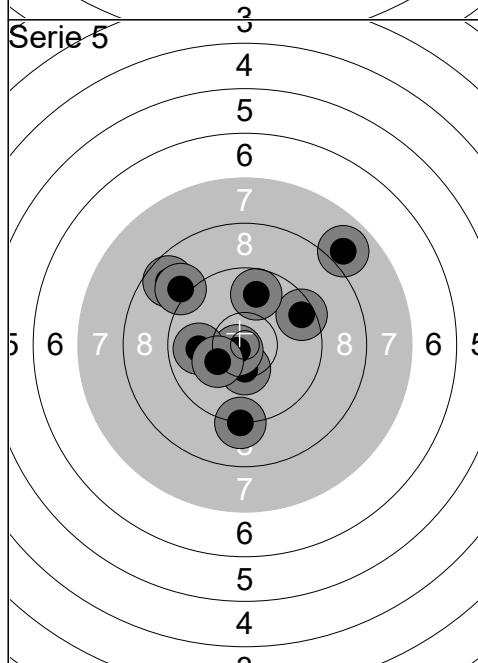

1:	10.4x	↘
2:	10.7x	↙
3:	7.9	↗
4:	8.7	↖
5:	9.9	←
6:	10.2	↙
7:	9.2	↓
8:	9.5	↗
9:	9.8	↗
10:	9.0	↖
Serie	90	(2x)
Total	451	(10x)

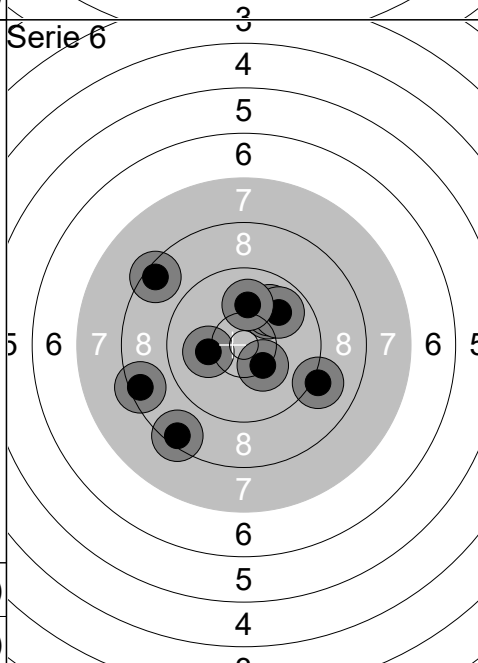

1:	10.1	↗
2:	8.5	↖
3:	10.3	↘
4:	9.1	↘
5:	10.0	↗
6:	9.9	↗
7:	8.5	←
8:	10.1	←
9:	8.4	↘
10:	10.0	↗
Serie	92	(0x)
Total	543	(10x)

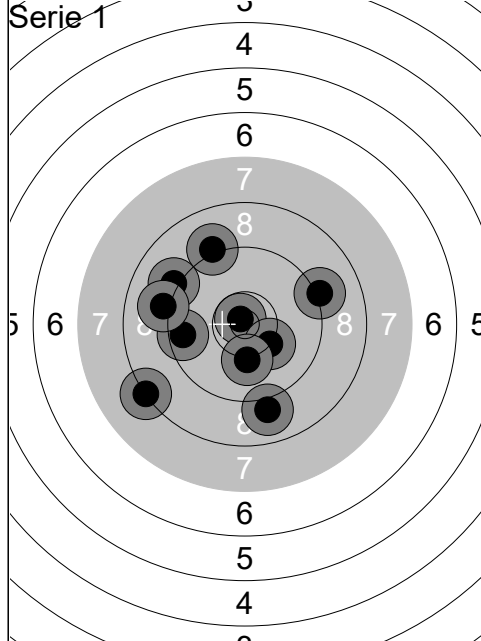

1:	9.1	↗
2:	10.8x	↘
3:	8.3	↙
4:	9.1	↖
5:	10.2	↘
6:	9.1	↗
7:	9.5	↙
8:	9.0	↘
9:	10.2	↘
10:	9.1	↖
Serie	92	(1x)
Total	92	(1x)

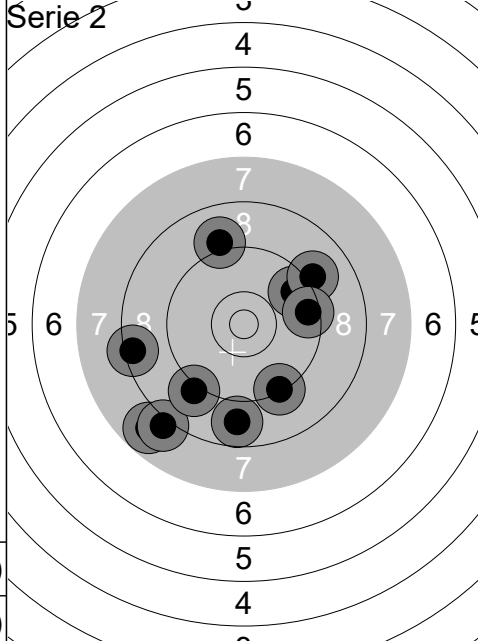

1:	8.4	↖
2:	9.0	↗
3:	9.3	↘
4:	7.8	↘
5:	9.6	↗
6:	8.1	↘
7:	9.1	↗
8:	9.1	↘
9:	8.8	↘
10:	9.5	↗
Serie	85	(0x)
Total	177	(1x)

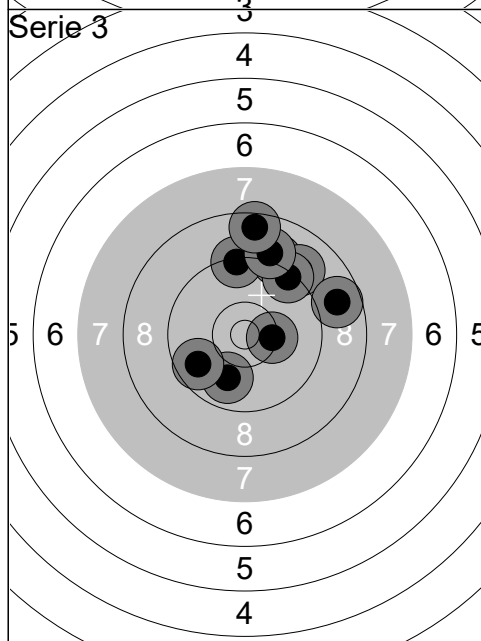

1:	9.1	↗
2:	10.3	→
3:	9.1	↗
4:	9.3	↗
5:	9.9	↘
6:	9.3	↗
7:	9.0	↗
8:	9.7	↖
9:	8.8	→
10:	8.5	↗
Serie	89	(0x)
Total	266	(1x)

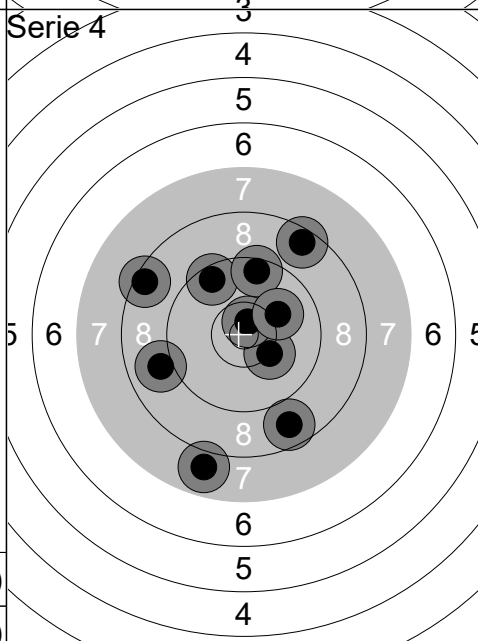

1:	10.2	↘
2:	9.5	↖
3:	9.0	↖
4:	10.6x	↗
5:	7.9	↘
6:	8.5	↗
7:	9.5	↗
8:	8.7	↘
9:	8.5	↖
10:	10.1	↗
Serie	88	(1x)
Total	354	(2x)

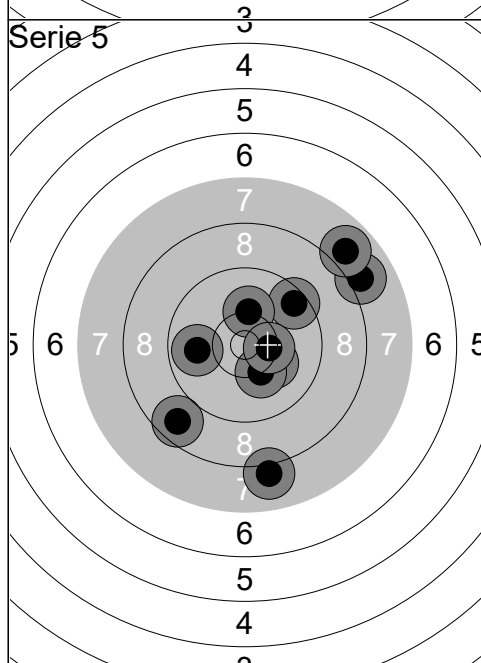

1:	9.5	↗
2:	10.2	↗
3:	10.2	↘
4:	10.2	↘
5:	8.7	↘
6:	8.0	↗
7:	7.9	↗
8:	10.4x	→
9:	9.9	↖
10:	8.0	↘
Serie	89	(1x)
Total	443	(3x)

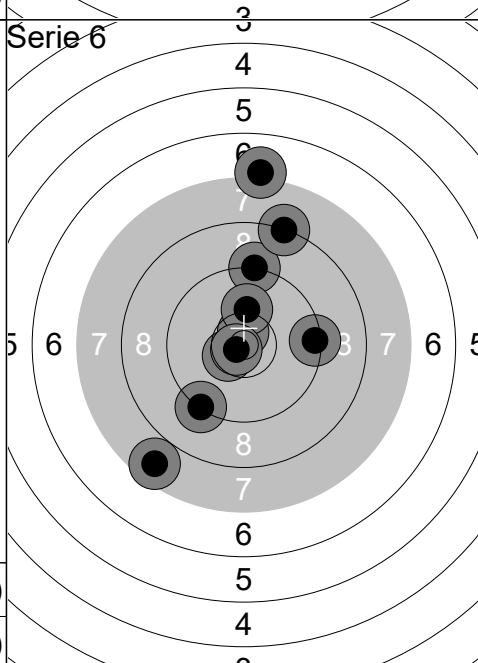

1:	9.3	↘
2:	9.4	→
3:	10.7x	↗
4:	10.5x	↖
5:	9.2	↗
6:	10.1	↗
7:	8.2	↗
8:	10.7x	↖
9:	7.6	↘
10:	7.1	↗
Serie	89	(3x)
Total	532	(6x)

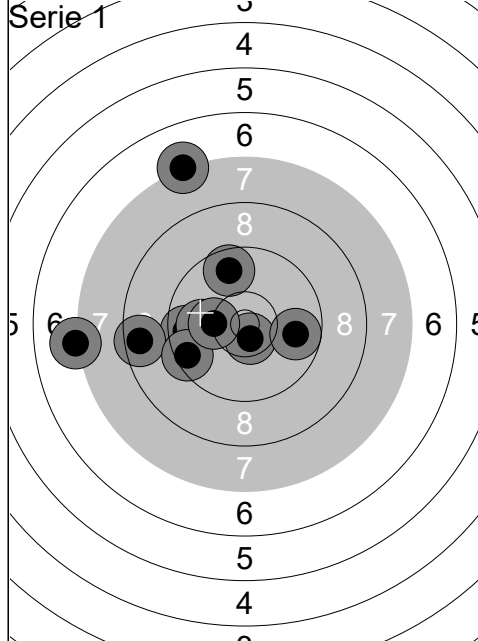

1:	9.6	←
2:	9.7	↑
3:	10.6x	↓
4:	7.2	↑
5:	7.1	←
6:	10.0	←
7:	8.6	←
8:	9.8	→
9:	9.5	←
10:	10.3	←
Serie		88 (1x)
Total		88 (1x)

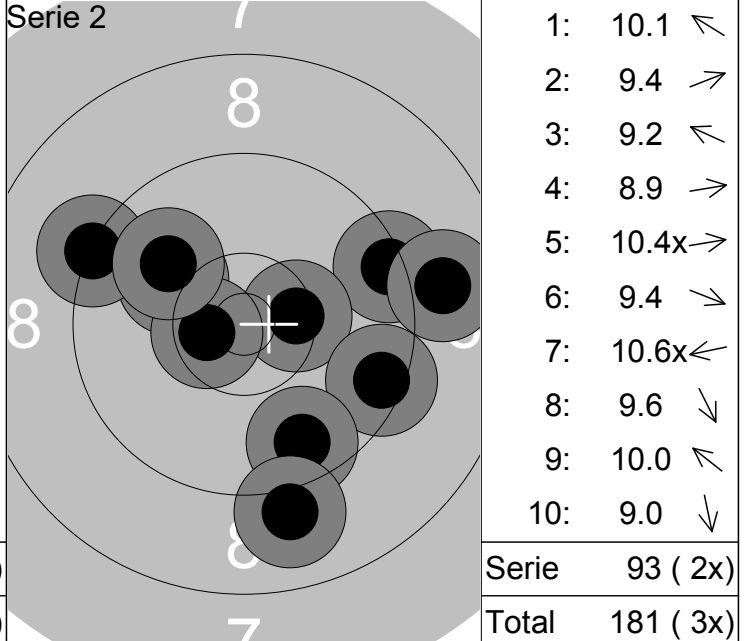

1:	10.1	↖
2:	9.4	→
3:	9.2	↖
4:	8.9	→
5:	10.4x	→
6:	9.4	→
7:	10.6x	←
8:	9.6	↓
9:	10.0	↖
10:	9.0	↓
Serie		93 (2x)
Total		181 (3x)

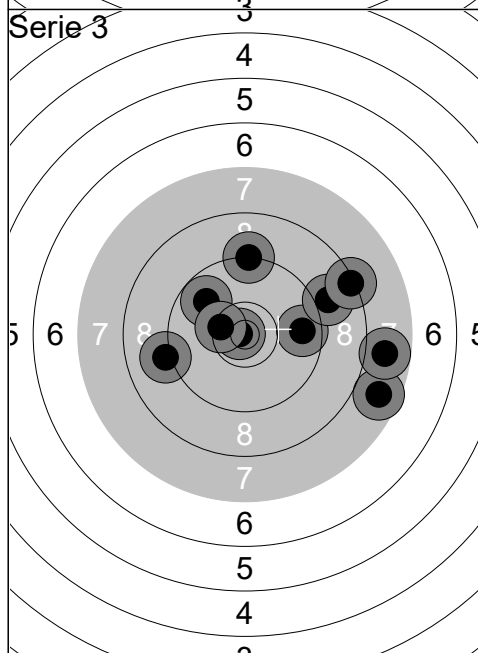

1:	10.8x	←
2:	7.7	→
3:	9.7	→
4:	7.8	→
5:	9.8	↖
6:	9.2	↑
7:	8.9	→
8:	8.3	↗
9:	9.1	←
10:	10.4x	←
Serie		86 (2x)
Total		267 (5x)

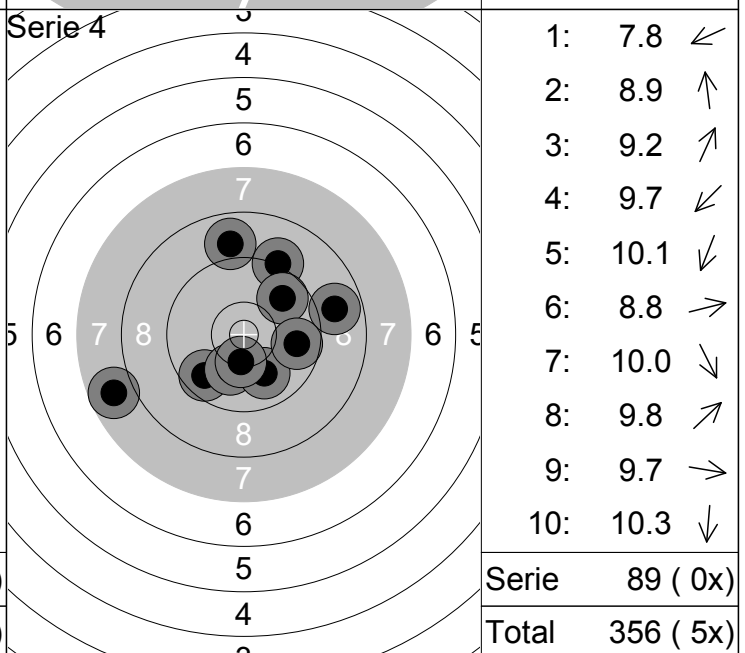

1:	7.8	←
2:	8.9	↑
3:	9.2	↗
4:	9.7	↖
5:	10.1	↓
6:	8.8	→
7:	10.0	↓
8:	9.8	↗
9:	9.7	→
10:	10.3	↓
Serie		89 (0x)
Total		356 (5x)

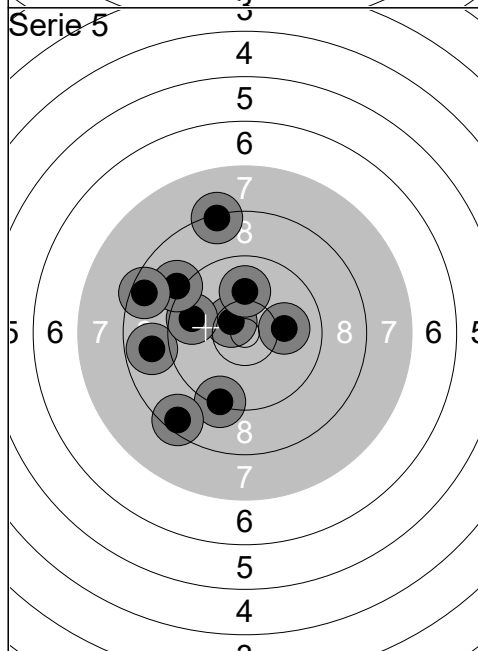

1:	10.6x	↖
2:	8.8	←
3:	10.1	→
4:	9.3	↓
5:	8.3	↑
6:	9.7	←
7:	8.5	↘
8:	9.1	↖
9:	8.5	←
10:	10.0	↑
Serie		89 (1x)
Total		445 (6x)

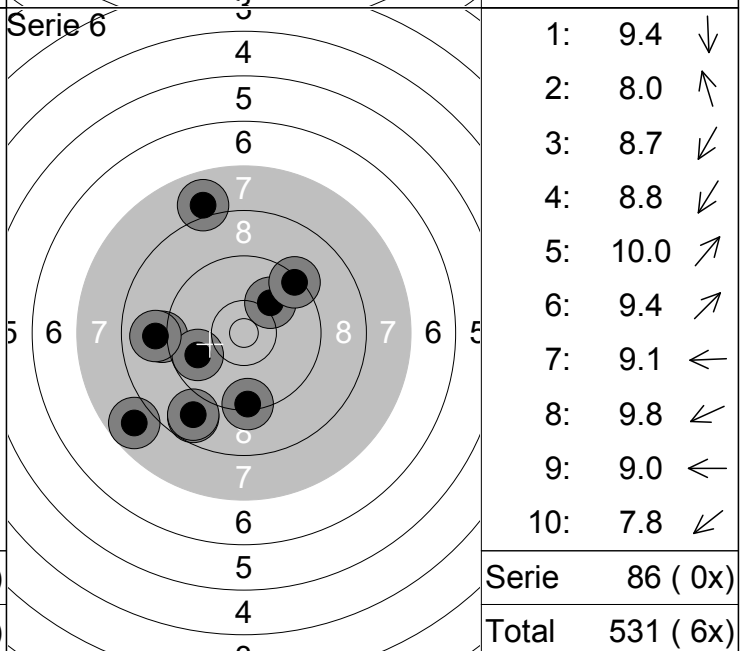

1:	9.4	↓
2:	8.0	↑
3:	8.7	↘
4:	8.8	↘
5:	10.0	↗
6:	9.4	↗
7:	9.1	←
8:	9.8	←
9:	9.0	←
10:	7.8	↘
Serie		86 (0x)
Total		531 (6x)

Skjutlag 1	Tavla 36	Jon Westberg	
1 Luft		Njurunda Sportskytteklubb	H 3
21.01.2024		Vinterträffen 2024	Umeå skytteallians
Serie 1		1: 9.3 ↘ 2: 9.2 ↗ 3: 9.8 ↖ 4: 9.0 → 5: 10.2 ↓ 6: 10.6x ↓ 7: 10.0 ← 8: 9.0 ↓ 9: 9.7 ↖ 10: 8.3 ↘	Serie 2
		Serie 92 (1x)	1: 8.3 ↗ 2: 10.5x ↘ 3: 10.2 ↖ 4: 9.9 ↓ 5: 9.0 ↓ 6: 10.0 ↓ 7: 10.3 ← 8: 8.4 → 9: 9.7 → 10: 9.4 ↓
		Total 92 (1x)	Serie 92 (1x)
			Total 184 (2x)
Serie 3		1: 8.8 ↑ 2: 9.1 ↖ 3: 9.3 ↖ 4: 10.3 ← 5: 10.2 ↘ 6: 8.6 ← 7: 9.2 ↑ 8: 10.4 ↘ 9: 10.5x ↑ 10: 9.4 ↗	Serie 4
		Serie 92 (1x)	1: 10.2 ↖ 2: 9.3 → 3: 9.5 ↓ 4: 10.3 ↖ 5: 9.8 ← 6: 8.0 ↓ 7: 9.8 ↑ 8: 9.6 ↓ 9: 7.9 ↖ 10: 10.2 ↖
		Total 276 (3x)	Serie 90 (0x)
			Total 366 (3x)
Serie 5		1: 9.7 ↖ 2: 9.2 ↖ 3: 10.4x ↗ 4: 10.5x ↓ 5: 10.4x → 6: 10.5x ↓ 7: 10.2 → 8: 10.2 → 9: 10.7x ↖ 10: 9.2 ↓	Serie 6
		Serie 97 (5x)	1: 8.5 ↓ 2: 9.8 ↓ 3: 10.4x ↖ 4: 10.5x ↖ 5: 7.8 ↓ 6: 9.6 ↓ 7: 9.3 ↓ 8: 10.5x → 9: 9.3 ↑ 10: 10.6x ↓
		Total 463 (8x)	Serie 91 (4x)
			Total 554 (12x)

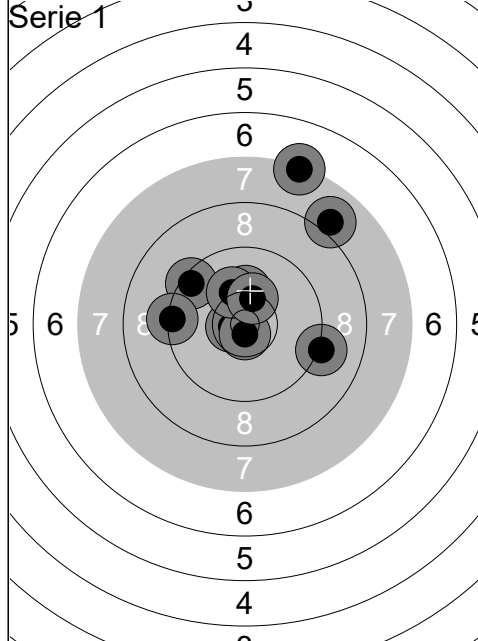

1:	9.4	↖
2:	9.2	➡
3:	10.6x	←
4:	10.2	↑
5:	7.3	↗
6:	10.7x	↓
7:	10.2	↗
8:	9.3	←
9:	10.3	↗
10:	8.0	↗
Serie	92 (2x)	
Total	92 (2x)	

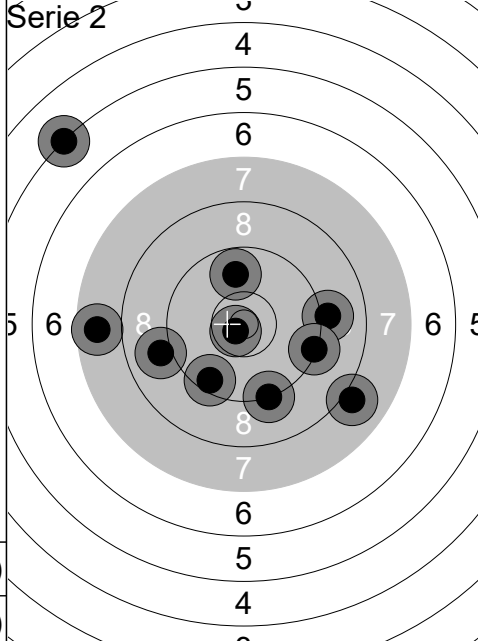

1:	9.5	↘
2:	5.2	↖
3:	9.1	➡
4:	10.7x	↙
5:	9.0	←
6:	7.7	←
7:	9.3	➡
8:	8.0	↘
9:	9.2	↘
10:	9.8	↑
Serie	84 (1x)	
Total	176 (3x)	

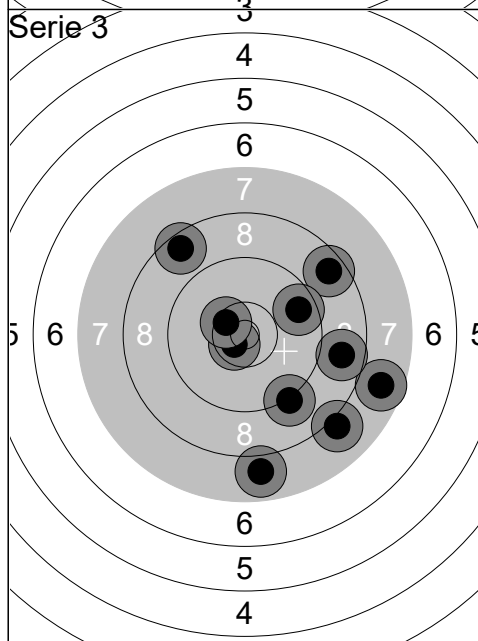

1:	10.6x	↙
2:	8.6	↗
3:	8.5	↗
4:	9.6	➡
5:	9.2	↘
6:	8.0	↘
7:	7.9	↓
8:	7.7	➡
9:	10.4x	↙
10:	8.8	➡
Serie	84 (2x)	
Total	260 (5x)	

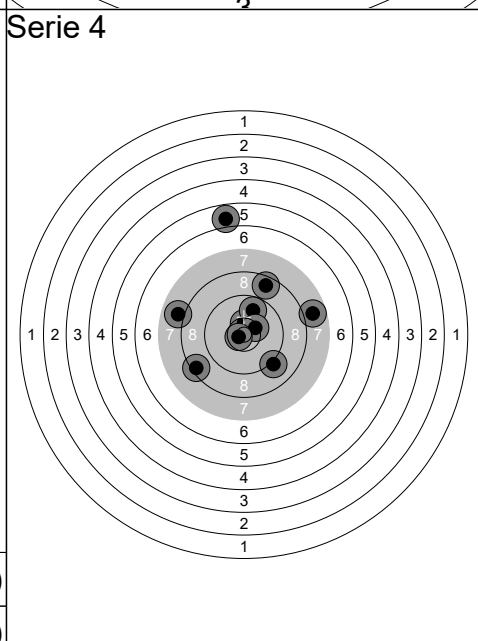

1:	10.5x	↑
2:	9.1	↘
3:	8.6	↗
4:	5.9	↑
5:	9.8	↗
6:	7.9	←
7:	7.8	➡
8:	8.4	↙
9:	10.4x	↗
10:	10.7x	↙
Serie	83 (3x)	
Total	343 (8x)	

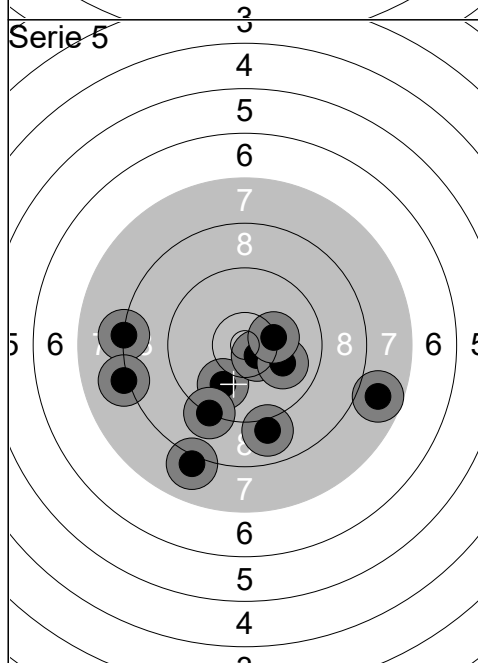

1:	8.2	←
2:	8.0	↘
3:	9.9	↘
4:	10.6x	↘
5:	7.8	➡
6:	8.1	←
7:	9.2	↘
8:	9.0	↘
9:	10.0	➡
10:	10.3	➡
Serie	88 (1x)	
Total	431 (9x)	

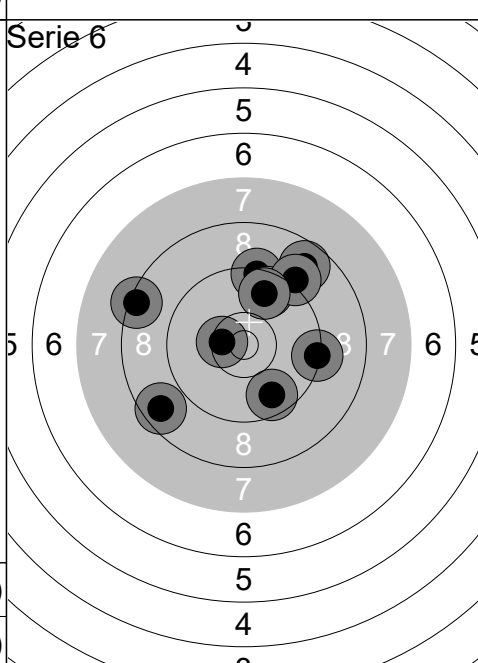

1:	9.3	↑
2:	10.5x	←
3:	9.7	↗
4:	8.4	←
5:	8.7	↗
6:	9.1	↗
7:	9.7	↘
8:	9.7	↗
9:	9.3	➡
10:	8.6	↙
Serie	88 (1x)	
Total	519 (10x)	

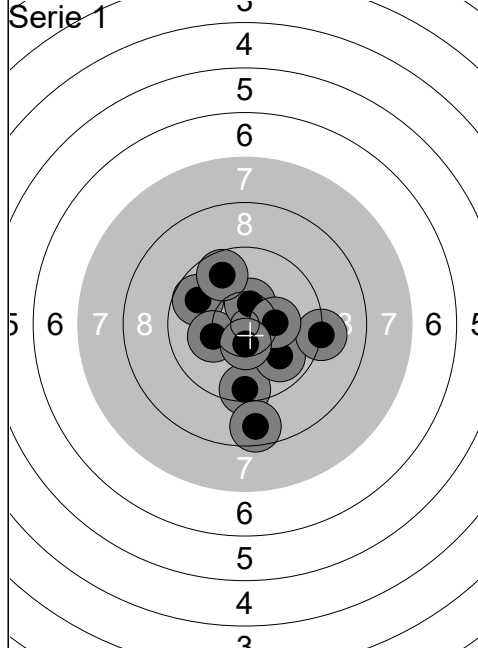

1:	9.8	↖
2:	9.5	↓
3:	8.7	↓
4:	10.2	↖
5:	10.5x	↗
6:	9.9	↘
7:	9.2	→
8:	10.3	→
9:	10.5x	↓
10:	9.7	↖
Serie		93 (2x)
Total		93 (2x)

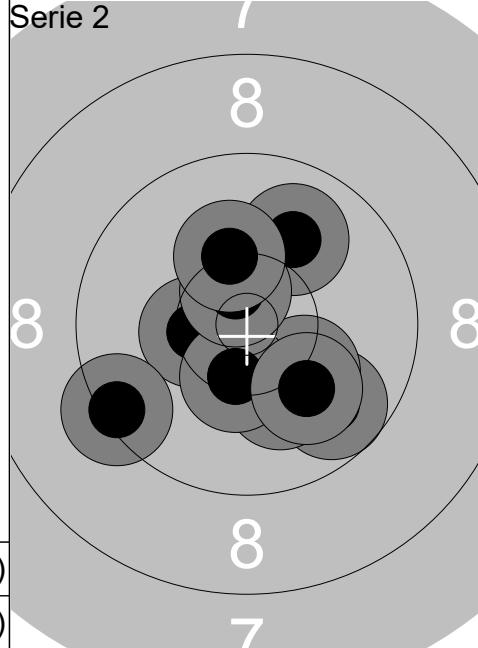

1:	9.8	↘
2:	10.2	↘
3:	10.0	↗
4:	10.2	↘
5:	10.4x	↖
6:	9.4	↖
7:	10.4x	↓
8:	10.1	↘
9:	10.6x	↗
10:	10.2	↗
Serie		98 (3x)
Total		191 (5x)

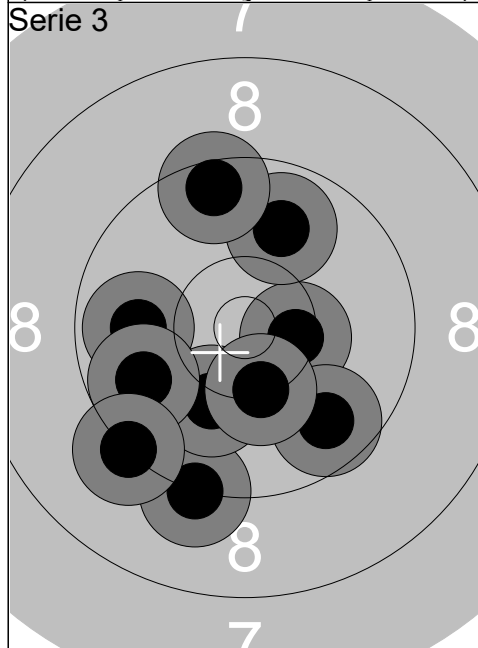

1:	9.9	↖
2:	9.2	↓
3:	10.4x	→
4:	9.9	↗
5:	9.5	↗
6:	9.7	↘
7:	10.1	↓
8:	9.8	↖
9:	10.3	↓
10:	9.2	↘
Serie		93 (1x)
Total		284 (6x)

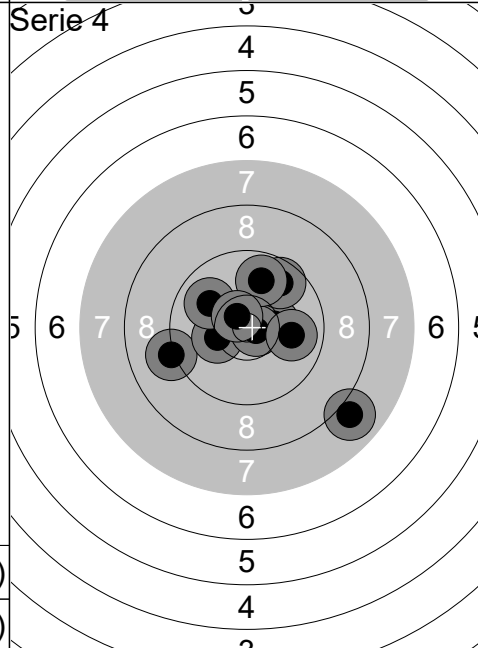

1:	9.2	↖
2:	10.2	↖
3:	10.3	→
4:	10.0	↖
5:	7.9	↘
6:	9.7	↗
7:	10.7x	→
8:	9.8	↗
9:	10.6x	↖
10:	9.9	→
Serie		93 (2x)
Total		377 (8x)

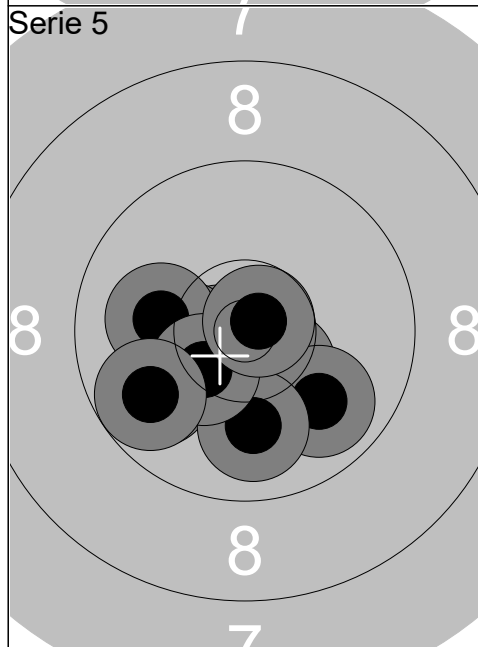

1:	10.7x	↖
2:	10.4x	↘
3:	10.3	↖
4:	9.9	↘
5:	9.9	↖
6:	10.0	↓
7:	10.1	↖
8:	10.4x	↖
9:	9.8	↖
10:	10.8x	↗
Serie		97 (4x)
Total		474 (12x)

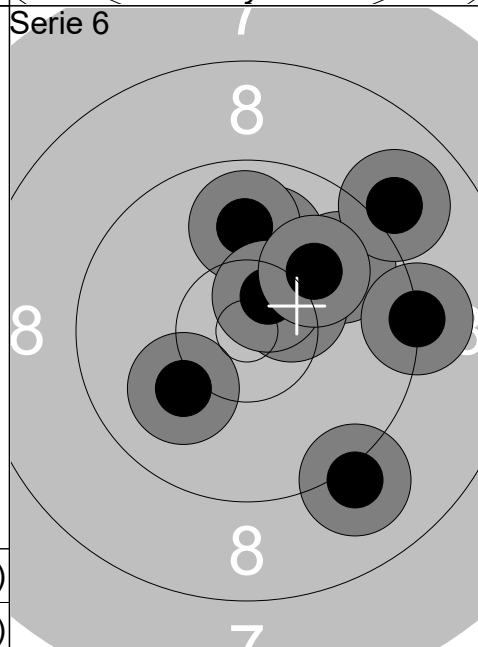

1:	10.0	↗
2:	10.1	↖
3:	9.8	↗
4:	9.2	→
5:	9.1	↘
6:	9.0	↗
7:	9.9	↗
8:	10.4x	↗
9:	10.5x	↗
10:	10.0	↗
Serie		95 (2x)
Total		569 (14x)

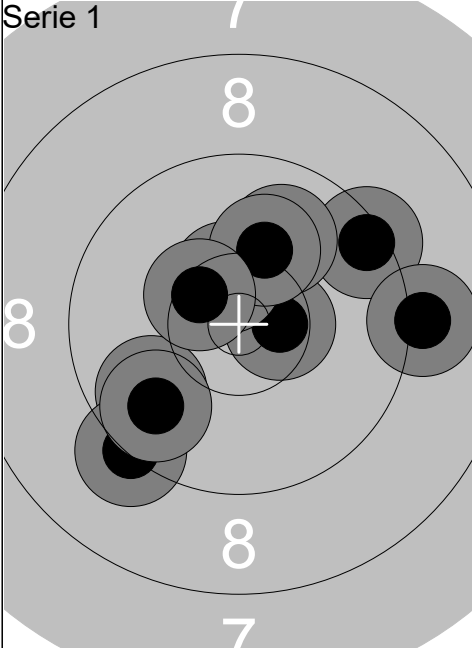
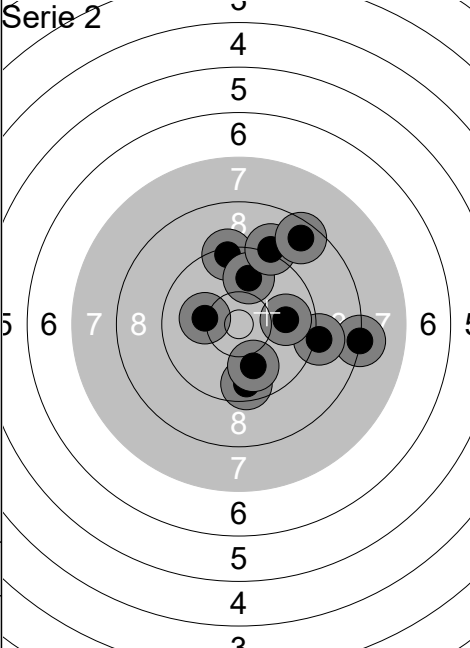
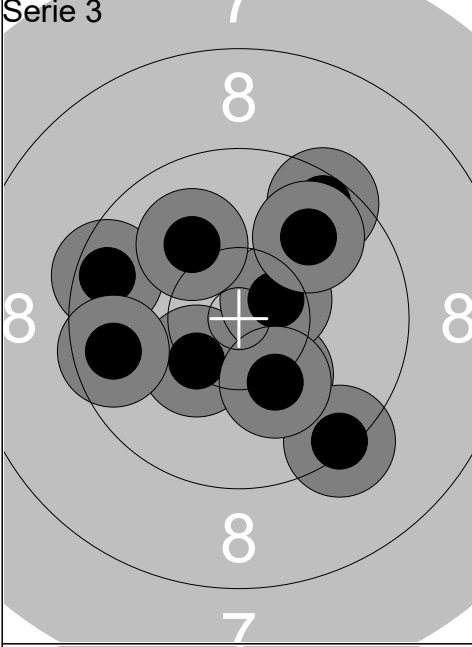
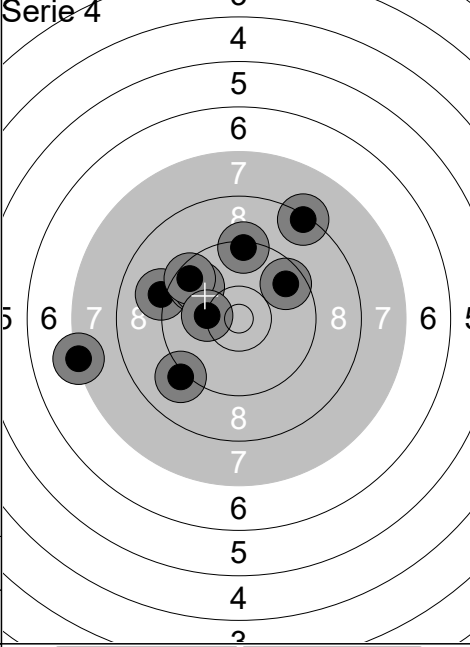
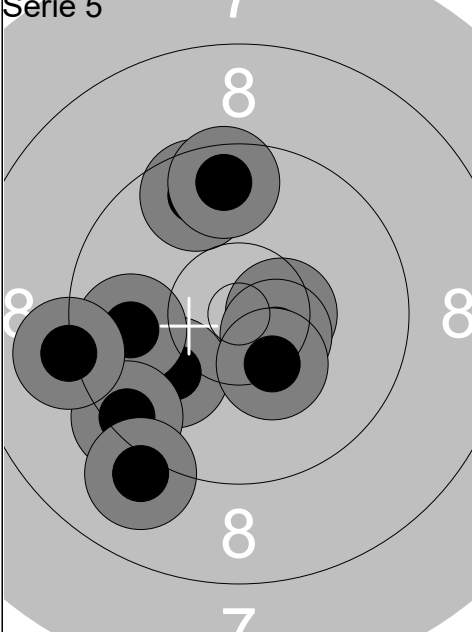
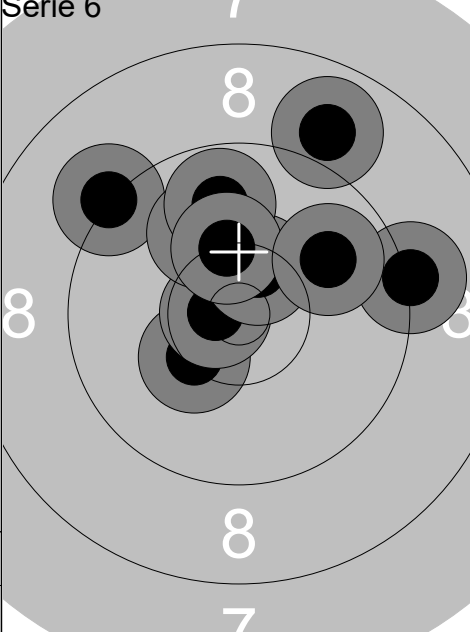
Skjutlag 1	Tavla 40	Lars Edvinsson			
1 Luft		Umeå Pistolskytteklubb	H 3		
21.01.2024		Vinterträffen 2024	Umeå skytteallians		
Serie 1		1: 10.5x → 2: 9.4 ↗ 3: 9.8 ↖ 4: 10.0 ↗ 5: 9.3 ↖ 6: 10.5x ↗ 7: 10.1 ↗ 8: 9.1 → 9: 10.4x ↖ 10: 9.8 ↖ Serie 95 (3x) Total 95 (3x)	Serie 2		1: 8.2 → 2: 9.4 ↑ 3: 9.1 → 4: 9.9 ↑ 5: 9.9 → 6: 9.1 ↗ 7: 10.2 ← 8: 9.6 ↓ 9: 10.0 ↓ 10: 8.6 ↗ Serie 90 (0x) Total 185 (3x)
Serie 3		1: 9.5 ← 2: 10.3 ↓ 3: 9.3 ↓ 4: 10.3 ↖ 5: 10.5x → 6: 9.5 ↗ 7: 10.1 ↗ 8: 10.2 ↓ 9: 9.6 ← 10: 9.9 ↗ Serie 95 (1x) Total 280 (4x)	Serie 4		1: 9.1 ↖ 2: 7.3 ← 3: 9.4 ↑ 4: 9.6 ↗ 5: 9.1 ← 6: 9.7 ↖ 7: 8.3 ↗ 8: 9.8 ↖ 9: 9.5 ↖ 10: 10.2 ← Serie 88 (0x) Total 368 (4x)
Serie 5		1: 9.7 ↗ 2: 10.5x → 3: 10.5x → 4: 10.1 ↖ 5: 9.8 ← 6: 10.3 ↓ 7: 9.4 ↖ 8: 9.1 ↖ 9: 9.6 ↑ 10: 9.2 ← Serie 94 (2x) Total 462 (6x)	Serie 6		1: 9.2 ↖ 2: 8.9 ↗ 3: 10.3 ↖ 4: 10.7x ← 5: 10.1 ↗ 6: 10.4x ↗ 7: 9.2 → 8: 9.8 ↑ 9: 10.3 ↑ 10: 9.9 ↗ Serie 94 (2x) Total 556 (8x)

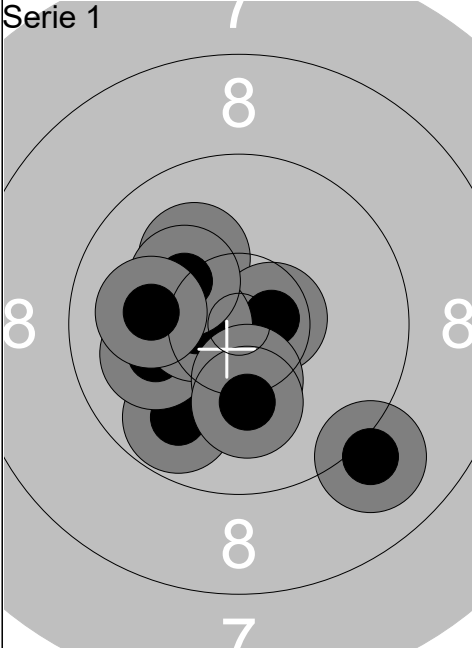
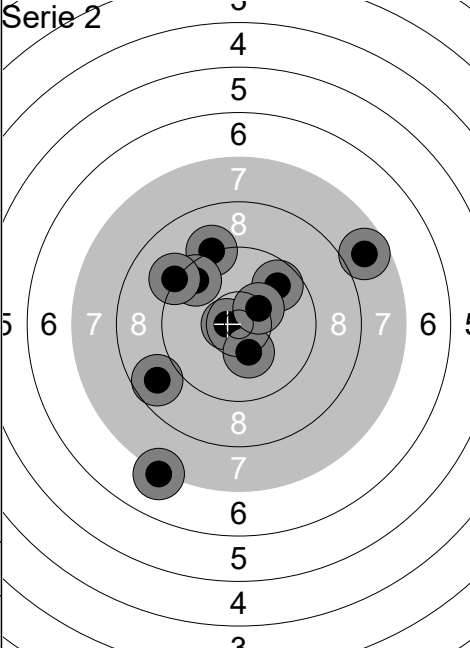
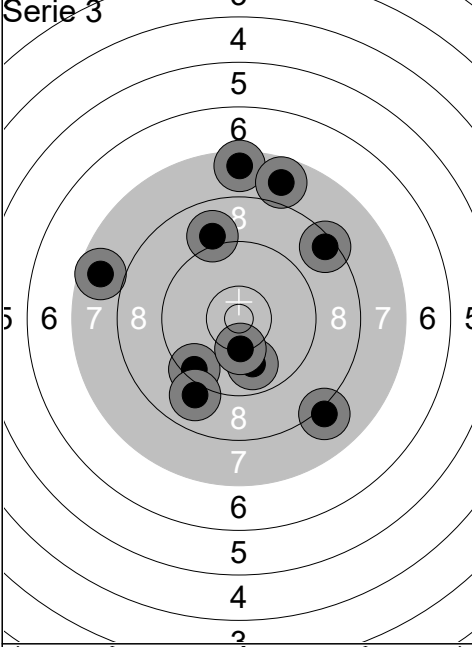
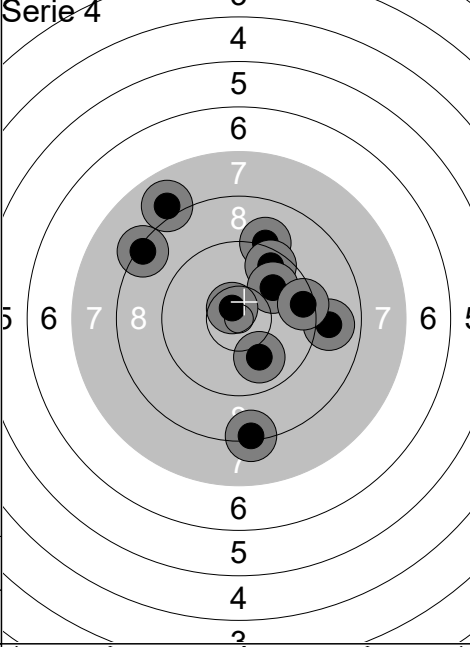
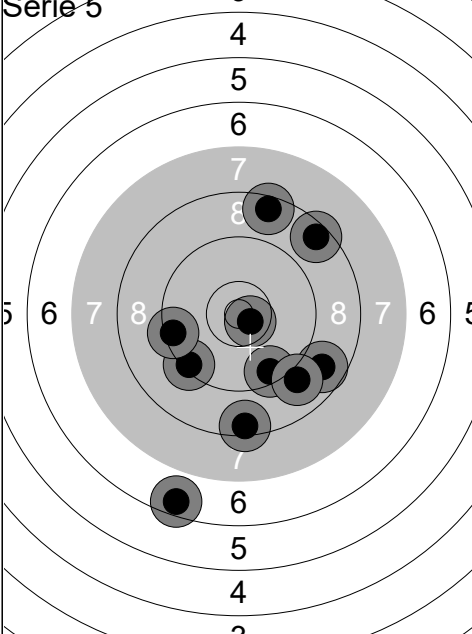
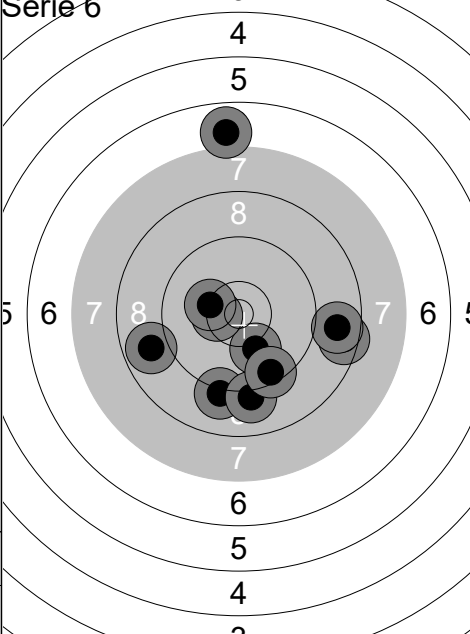
Skjutlag	Tavla	Valter Vestin			
1 Luft	Dorotea Pistolsskytteklubb	H 2			
21.01.2024	Vinterträffen 2024	Umeå skytteallians			
Serie 1		1: 9.8 ↘ 2: 10.1 ↗ 3: 10.6x → 4: 10.1 ← 5: 10.5x ← 6: 9.1 ↘ 7: 10.2 ↗ 8: 10.4x ↓ 9: 10.1 ↓ 10: 10.1 ←	Serie 2		1: 9.2 ↗ 2: 9.6 ↗ 3: 10.7x ← 4: 10.3 ↓ 5: 7.2 ↓ 6: 9.7 ↗ 7: 9.2 ↗ 8: 7.7 ↗ 9: 8.7 ↘ 10: 10.4x ↗
	Serie 98 (3x)		Serie 88 (2x)		
	Total 98 (3x)		Total 186 (5x)		
Serie 3		1: 7.5 ↑ 2: 7.7 ← 3: 8.1 ↓ 4: 9.4 ↓ 5: 8.4 ↗ 6: 9.0 ↓ 7: 9.9 ↓ 8: 7.8 ↑ 9: 10.3 ↓ 10: 9.0 ↑	Serie 4		1: 9.2 ↑ 2: 9.6 ↑ 3: 8.9 → 4: 9.9 ↗ 5: 8.0 ↑ 6: 10.7x ↗ 7: 8.3 ↗ 8: 8.3 ↓ 9: 10.0 ↓ 10: 9.5 →
	Serie 83 (0x)		Serie 88 (1x)		
	Total 269 (5x)		Total 357 (6x)		
Serie 5		1: 10.6x ↘ 2: 8.7 ↘ 3: 9.4 ↘ 4: 8.5 ↑ 5: 8.5 ↓ 6: 8.5 ↗ 7: 9.4 ← 8: 9.5 ↓ 9: 9.0 ↓ 10: 6.5 ↓	Serie 6		1: 6.9 ↑ 2: 10.1 ↓ 3: 8.5 → 4: 9.1 ↓ 5: 10.5x ← 6: 10.3 ← 7: 9.1 ↓ 8: 8.7 → 9: 8.9 ← 10: 9.5 ↓
	Serie 84 (1x)		Serie 87 (1x)		
	Total 441 (7x)		Total 528 (8x)		

21.01.2024

Vinterträffen 2024

Umeå skytteallians

Serie 1

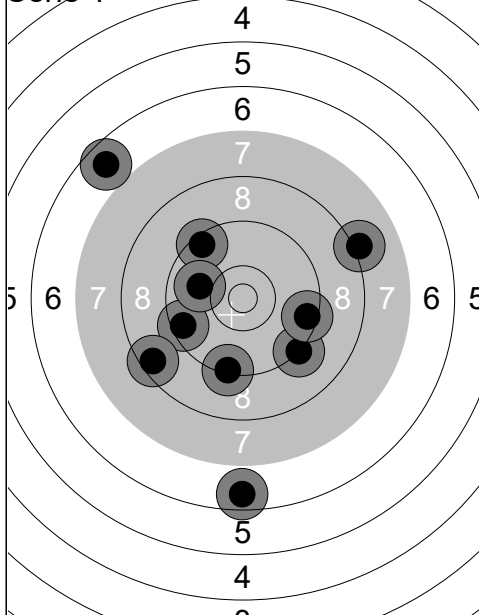

1: 6.7 ↗
 2: 9.5 ←
 3: 9.4 ↗
 4: 9.2 ↘
 5: 9.3 ↓
 6: 9.9 ←
 7: 9.5 →
 8: 8.5 ←
 9: 6.6 ↓
 10: 8.1 →

Serie 82 (0x)

Total 82 (0x)

Serie 2

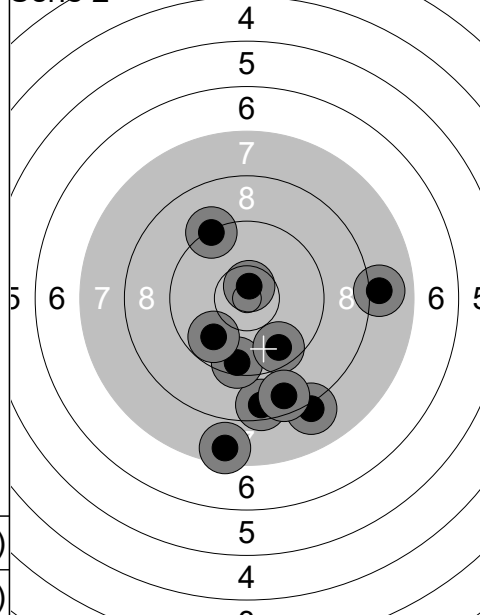

1: 7.6 ↓
 2: 8.5 ↓
 3: 8.0 →
 4: 9.5 ↓
 5: 10.7x ↑
 6: 9.8 ↘
 7: 9.3 ↗
 8: 9.6 ↘
 9: 8.1 ↓
 10: 8.6 ↓

Serie 85 (1x)

Total 167 (1x)

Serie 3

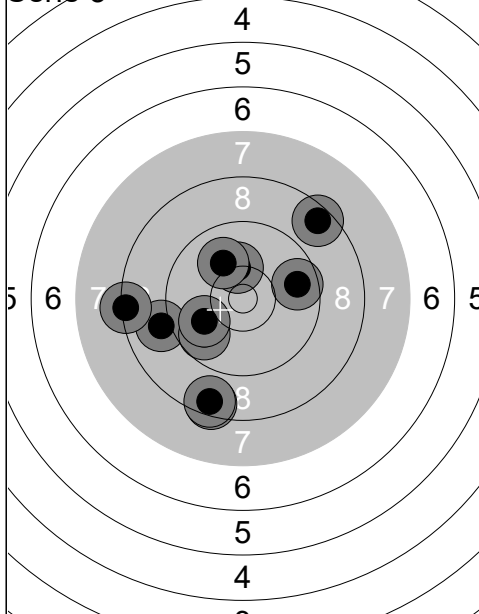

1: 9.0 ←
 2: 8.3 ←
 3: 9.8 ↘
 4: 10.3 ↑
 5: 9.9 ←
 6: 10.0 ↗
 7: 9.7 →
 8: 8.5 ↗
 9: 8.5 ↓
 10: 8.5 ↓

Serie 88 (0x)

Total 255 (1x)

Serie 4

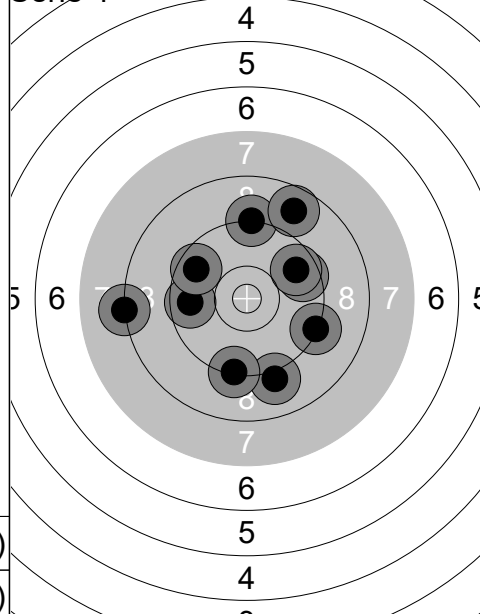

1: 9.6 →
 2: 9.7 ↗
 3: 9.7 ←
 4: 9.3 →
 5: 9.2 ↑
 6: 9.1 ↓
 7: 9.6 ↗
 8: 8.2 ←
 9: 9.3 ↓
 10: 8.7 ↗

Serie 88 (0x)

Total 343 (1x)

Serie 5

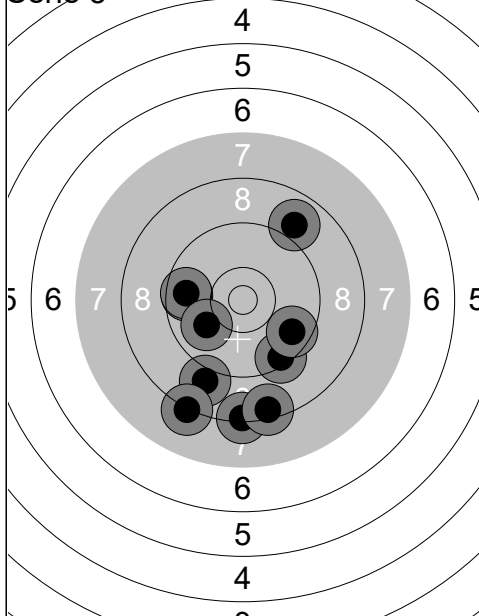

1: 9.7 ←
 2: 9.0 ↓
 3: 9.4 ↘
 4: 8.3 ↓
 5: 8.2 ↓
 6: 9.7 ←
 7: 8.9 ↗
 8: 10.0 ←
 9: 8.4 ↓
 10: 9.6 ↘

Serie 87 (0x)

Total 430 (1x)

Serie 6

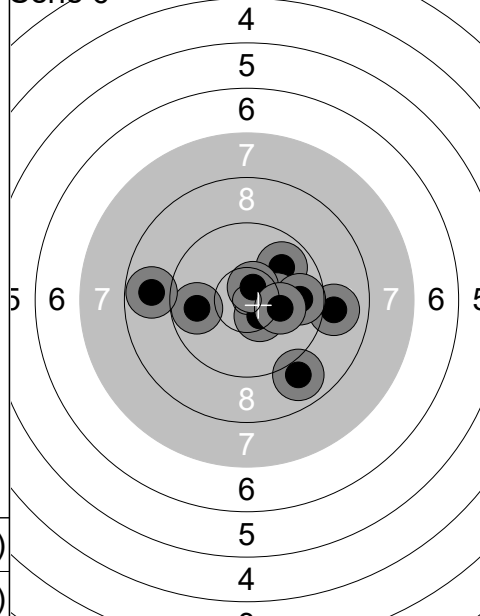

1: 9.9 ↗
 2: 9.0 →
 3: 10.5x ↘
 4: 10.3 →
 5: 10.6x ↗
 6: 9.8 ←
 7: 8.8 ←
 8: 9.8 →
 9: 10.2 →
 10: 8.9 ↓

Serie 92 (2x)

Total 522 (3x)

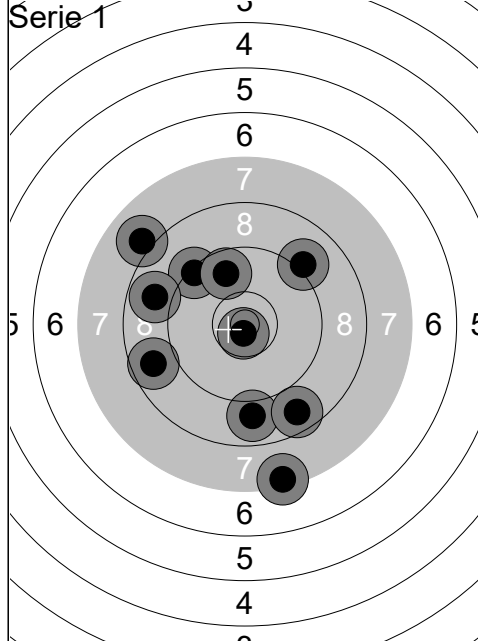

1:	10.7x	↓
2:	9.3	↖
3:	8.0	↖
4:	7.4	↓
5:	8.8	←
6:	8.9	↓
7:	9.7	↑
8:	9.1	↗
9:	8.7	←
10:	8.7	↓
Serie		84 (1x)
Total		84 (1x)

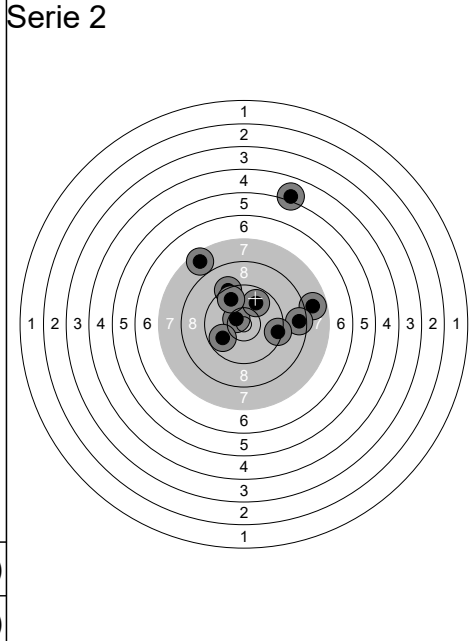

1:	9.3	↗
2:	7.6	↖
3:	7.9	→
4:	8.5	→
5:	10.5x	↖
6:	5.0	↑
7:	9.9	↗
8:	9.9	←
9:	9.5	→
10:	9.7	↖
Serie		82 (1x)
Total		166 (2x)

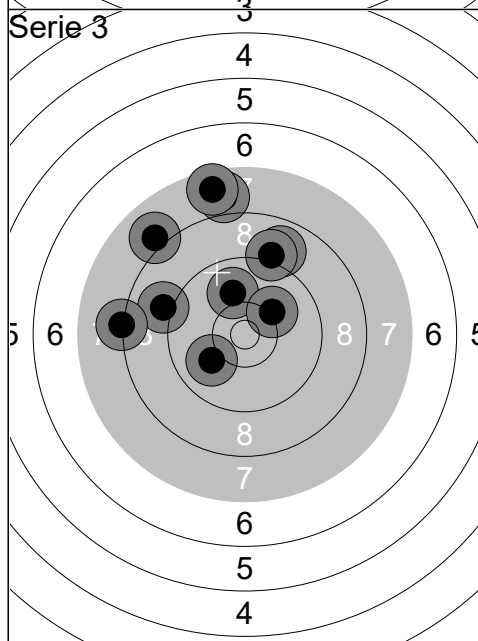

1:	8.9	↗
2:	10.0	↑
3:	8.0	↖
4:	7.8	↑
5:	10.1	↗
6:	10.0	←
7:	9.1	↑
8:	9.0	←
9:	8.2	←
10:	7.6	↑
Serie		86 (0x)
Total		252 (2x)

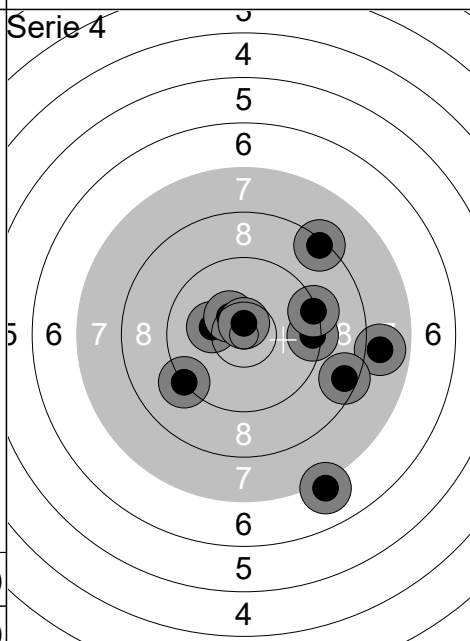

1:	10.2	←
2:	9.4	→
3:	10.4x	↖
4:	7.9	→
5:	9.2	↙
6:	10.7x	↑
7:	7.1	↓
8:	9.3	→
9:	8.3	↗
10:	8.5	→
Serie		87 (2x)
Total		339 (4x)

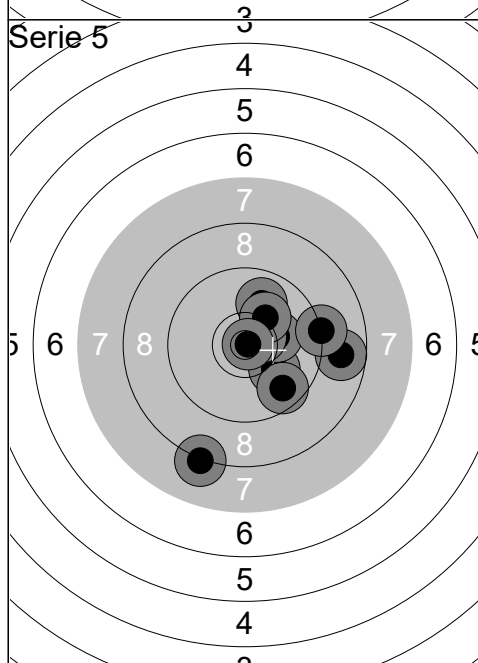

1:	10.1	↓
2:	10.2	→
3:	8.8	→
4:	9.7	↓
5:	10.6x	→
6:	10.0	↑
7:	10.2	↗
8:	10.9x	→
9:	8.2	↓
10:	9.2	→
Serie		94 (2x)
Total		433 (6x)

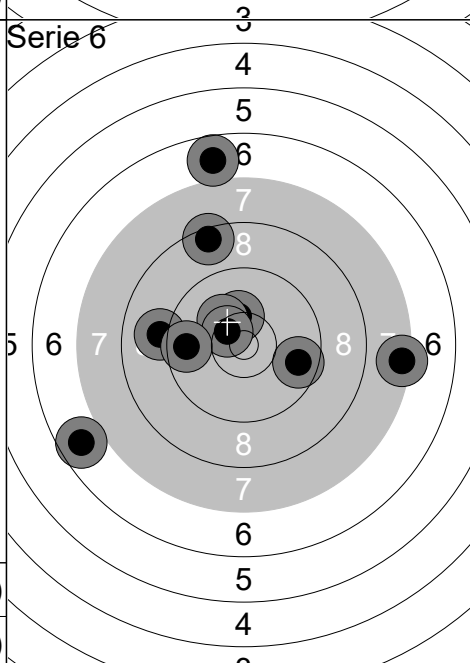

1:	7.4	→
2:	9.7	→
3:	8.4	↑
4:	9.1	←
5:	10.3	↑
6:	10.2	↖
7:	10.5x	↖
8:	9.7	←
9:	6.8	↑
10:	6.7	↙
Serie		84 (1x)
Total		517 (7x)

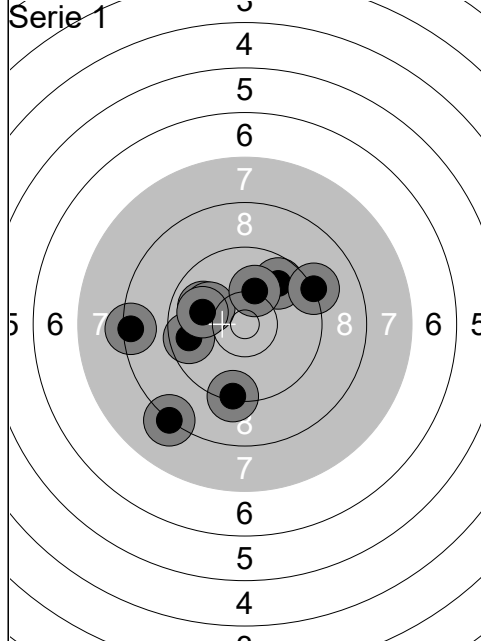

1:	8.2	↙
2:	9.8	↗
3:	9.9	↖
4:	8.4	↖
5:	10.1	↖
6:	9.3	↘
7:	10.2	↗
8:	9.2	↗
9:	9.7	↖
10:	10.0	↖
Serie		91 (0x)
Total		91 (0x)

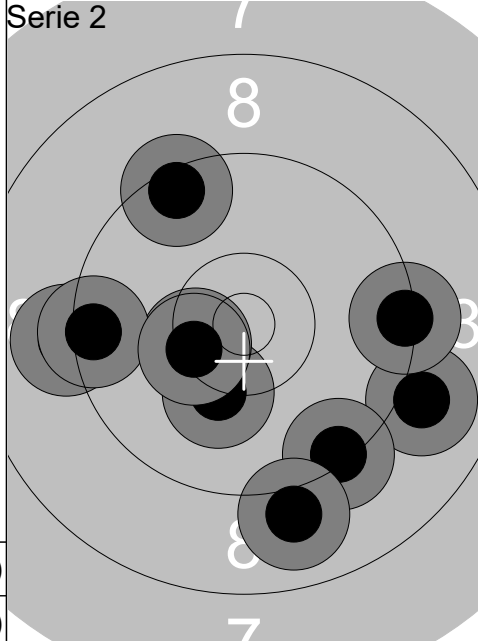

1:	9.0	→
2:	10.2	↘
3:	9.1	↖
4:	10.4x	↖
5:	9.4	↖
6:	9.3	→
7:	9.3	↘
8:	9.0	↘
9:	10.4x	↖
10:	9.4	↗
Serie		93 (2x)
Total		184 (2x)

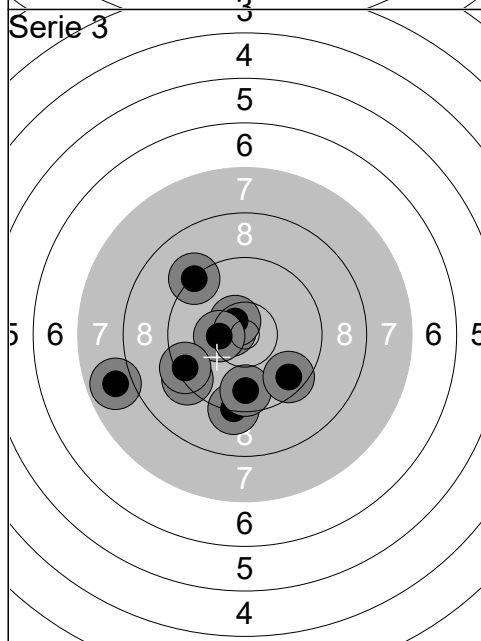

1:	9.3	↖
2:	9.3	↘
3:	10.6x	↖
4:	7.9	↖
5:	9.3	↘
6:	10.6x	↗
7:	9.7	↘
8:	10.4x	↖
9:	9.4	↖
10:	9.6	↘
Serie		91 (3x)
Total		275 (5x)

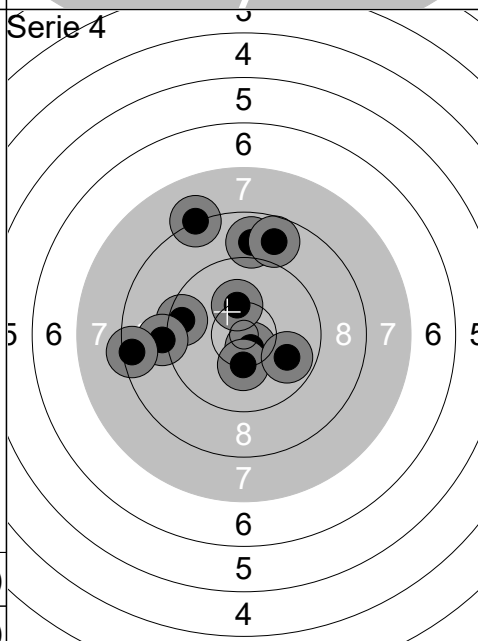

1:	8.9	↗
2:	10.6x	↘
3:	9.5	↖
4:	9.1	↖
5:	8.8	↗
6:	8.2	↗
7:	10.3	↘
8:	8.4	↖
9:	10.3	↗
10:	9.9	↗
Serie		89 (1x)
Total		364 (6x)

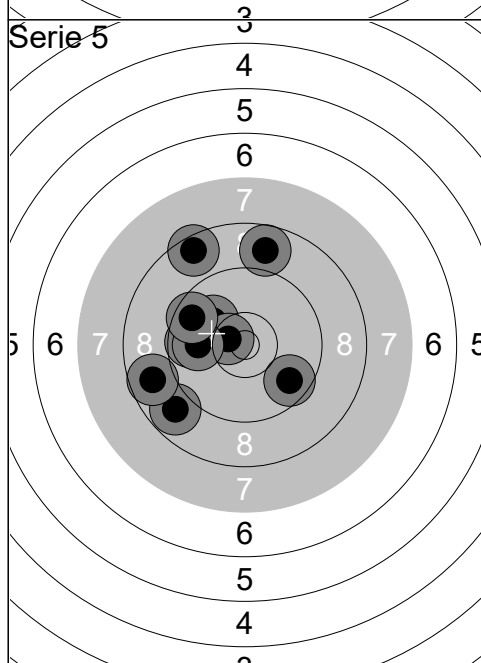

1:	8.8	↗
2:	10.1	↖
3:	8.6	↗
4:	8.8	↘
5:	9.7	↘
6:	10.5x	↖
7:	9.7	↖
8:	9.9	↖
9:	9.6	↖
10:	8.7	↖
Serie		88 (1x)
Total		452 (7x)

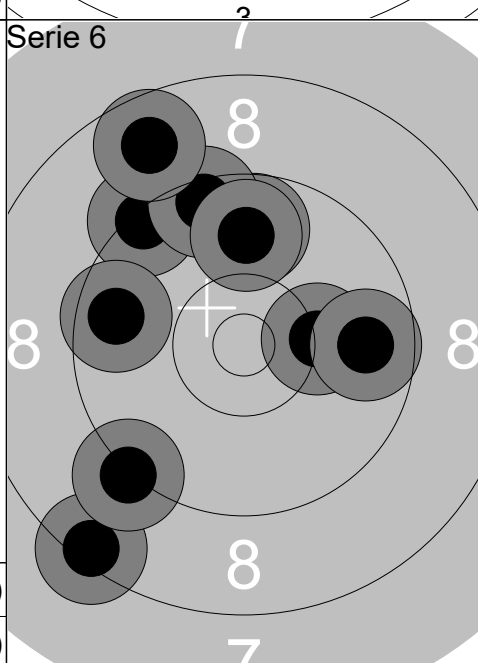

1:	10.2	→
2:	9.3	↖
3:	9.8	↗
4:	9.6	↖
5:	9.5	↗
6:	8.4	↘
7:	8.7	↗
8:	9.2	↘
9:	9.8	↗
10:	9.7	→
Serie		89 (0x)
Total		541 (7x)

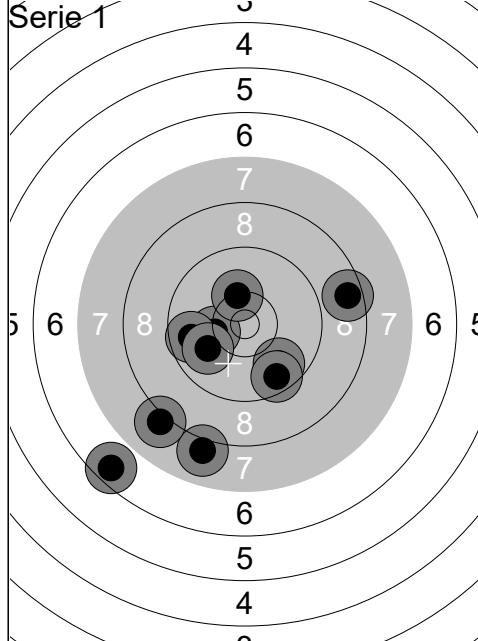

1:	9.8	↘
2:	10.3	←
3:	9.7	←
4:	8.0	↘
5:	10.3	↑
6:	8.6	→
7:	10.0	←
8:	9.6	↘
9:	6.6	↘
10:	8.1	↘
Serie		87 (0x)
Total		87 (0x)

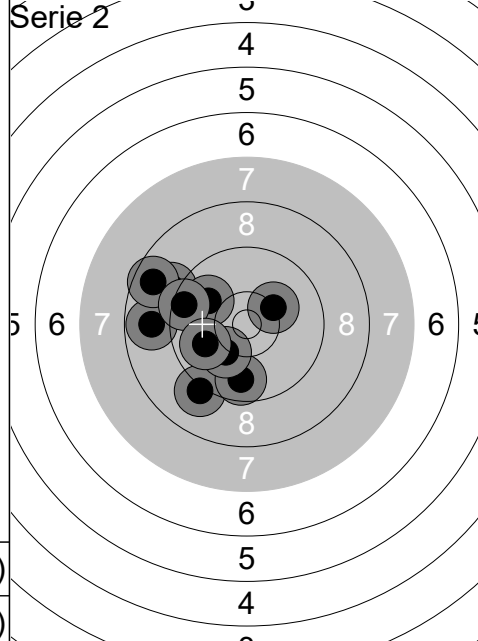

1:	9.1	↘
2:	9.1	←
3:	9.7	↘
4:	8.8	←
5:	10.2	↘
6:	8.6	←
7:	9.9	←
8:	9.5	←
9:	10.3	↗
10:	9.9	←
Serie		90 (0x)
Total		177 (0x)

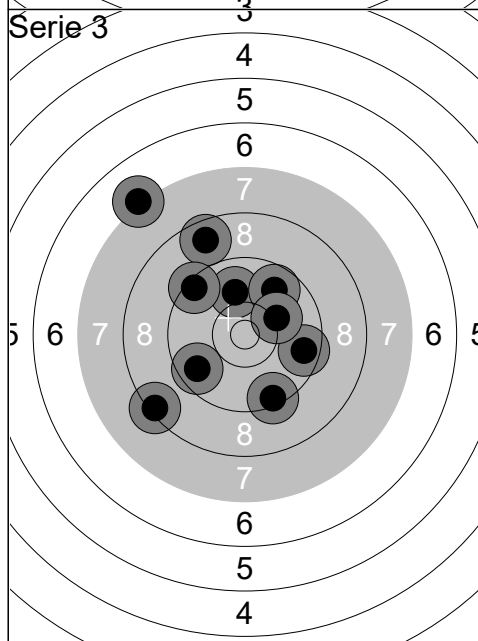

1:	8.4	←
2:	8.7	↑
3:	10.0	↑
4:	7.1	↗
5:	9.6	←
6:	9.4	↗
7:	9.7	↗
8:	9.4	↘
9:	9.6	→
10:	10.1	↗
Serie		88 (0x)
Total		265 (0x)

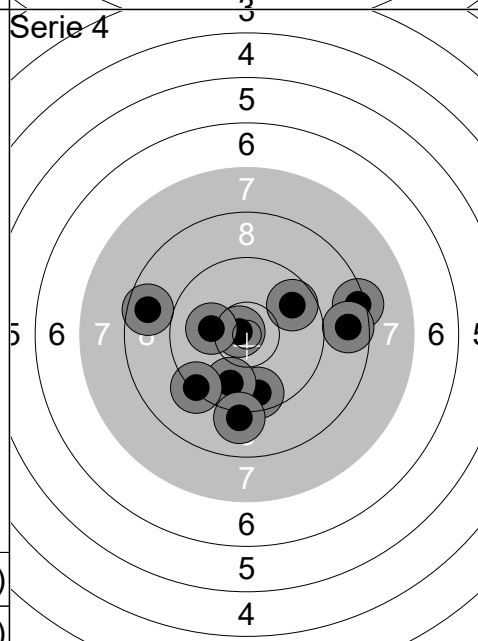

1:	9.6	↘
2:	8.7	←
3:	9.7	↗
4:	8.4	→
5:	9.8	↘
6:	10.8x	←
7:	9.3	↘
8:	8.7	→
9:	9.1	↘
10:	10.1	←
Serie		89 (1x)
Total		354 (1x)

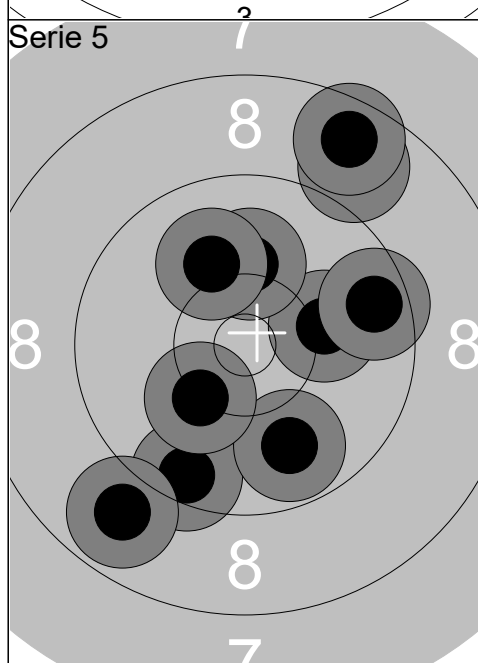

1:	10.1	→
2:	8.8	↗
3:	10.1	↑
4:	9.5	↘
5:	9.8	↘
6:	9.6	→
7:	10.2	↘
8:	10.1	↗
9:	8.6	↗
10:	8.9	↘
Serie		91 (0x)
Total		445 (1x)

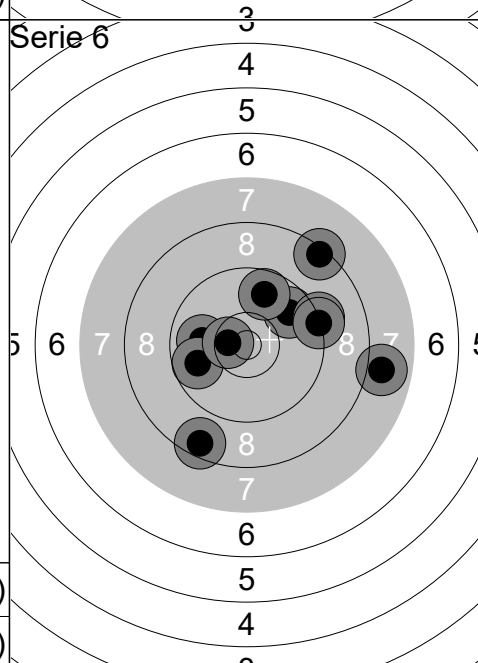

1:	8.5	↘
2:	9.8	↗
3:	9.8	↑
4:	9.2	→
5:	9.9	←
6:	9.8	←
7:	7.9	→
8:	9.3	→
9:	10.5x	←
10:	8.4	↗
Serie		87 (1x)
Total		532 (2x)

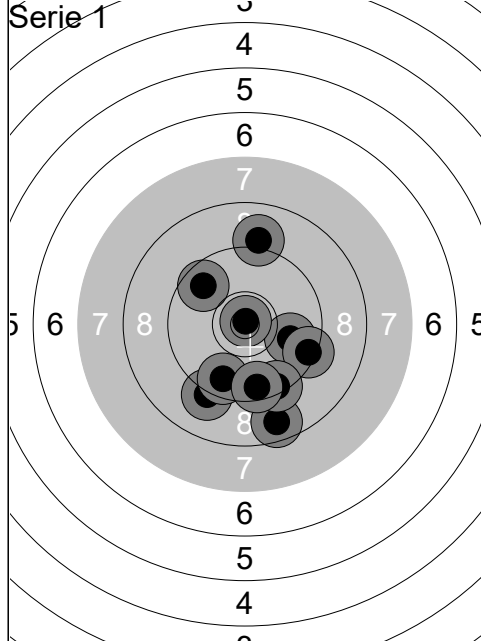

1:	9.9	➔
2:	9.4	➔
3:	8.7	⬇
4:	9.2	⬇
5:	10.9x	⬆
6:	9.6	⬇
7:	9.4	⬇
8:	9.5	⬇
9:	9.1	⬆
10:	9.7	↖
Serie	90	(1x)
Total	90	(1x)

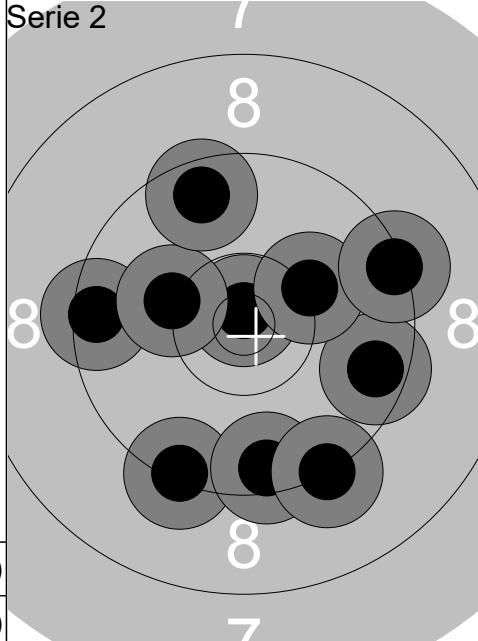

1:	10.8x	⬆
2:	9.3	⬇
3:	9.5	⬇
4:	9.5	➔
5:	9.5	⬅
6:	10.2	↗
7:	9.3	➔
8:	9.2	⬇
9:	10.2	⬅
10:	9.6	⬆
Serie	93	(1x)
Total	183	(2x)

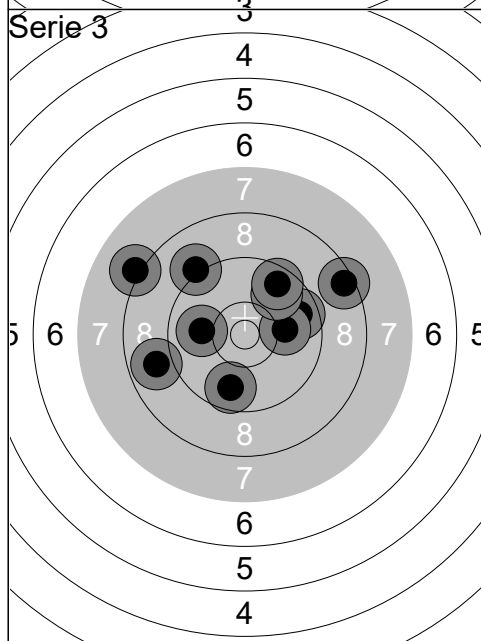

1:	9.7	⬇
2:	9.6	➔
3:	8.9	⬅
4:	10.1	➔
5:	8.4	➔
6:	10.0	⬅
7:	8.1	↖
8:	9.8	↗
9:	9.1	↖
10:	9.6	↗
Serie	89	(0x)
Total	272	(2x)

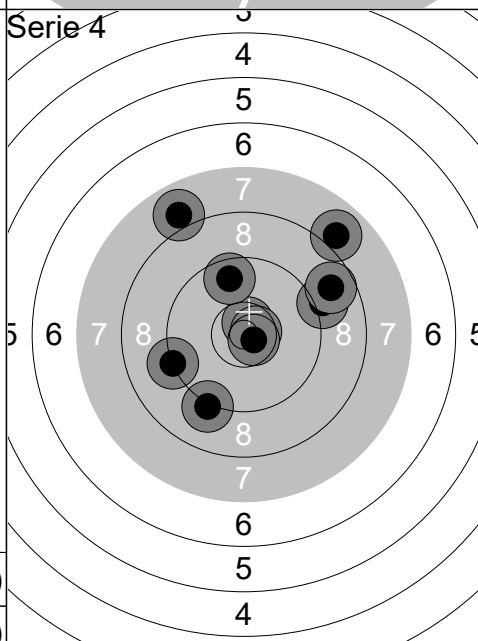

1:	10.6x	⬆
2:	9.1	➔
3:	9.6	⬆
4:	10.7x	➔
5:	7.9	↖
6:	8.7	➔
7:	7.9	↗
8:	10.7x	➔
9:	9.2	⬅
10:	9.1	⬇
Serie	88	(3x)
Total	360	(5x)

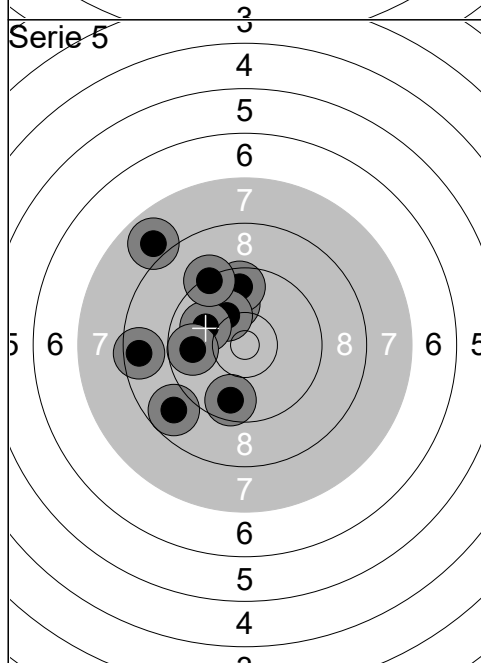

1:	10.0	⬆
2:	9.6	⬆
3:	10.2	↖
4:	10.0	⬅
5:	8.8	⬇
6:	7.9	↗
7:	9.3	↗
8:	8.6	⬅
9:	9.8	⬅
10:	9.7	⬇
Serie	89	(0x)
Total	449	(5x)

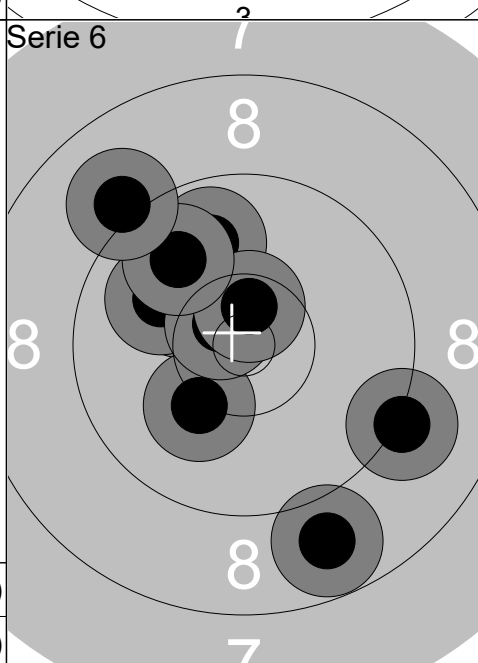

1:	9.2	➔
2:	10.2	↖
3:	10.2	⬇
4:	10.0	⬅
5:	9.9	⬆
6:	10.6x	↖
7:	10.6x	⬆
8:	8.8	⬇
9:	9.9	↗
10:	9.1	↖
Serie	94	(2x)
Total	543	(7x)

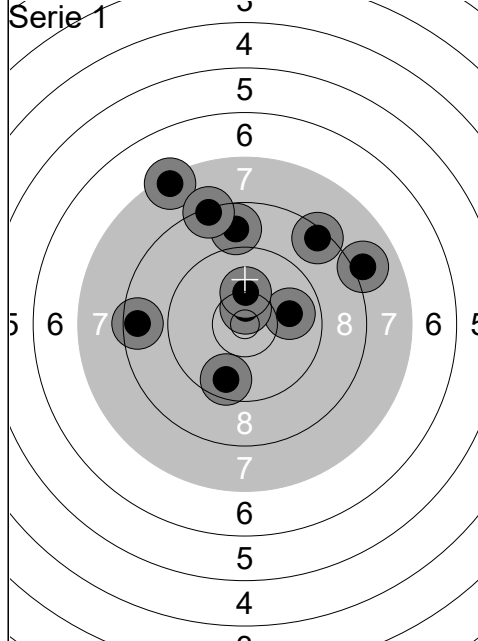

1:	9.9	→
2:	7.4	↖
3:	8.6	←
4:	8.4	↗
5:	9.7	↘
6:	10.6x	↑
7:	8.0	→
8:	10.2	↑
9:	8.8	↑
10:	8.3	↑
Serie		85 (1x)
Total		85 (1x)

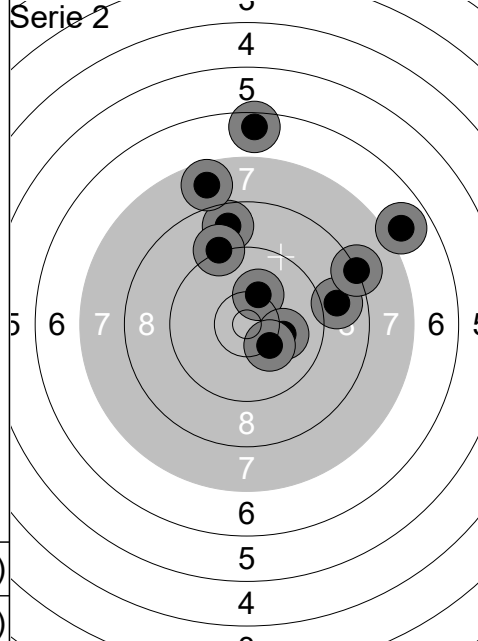

1:	6.6	↑
2:	10.2	↑
3:	10.1	→
4:	8.9	→
5:	10.3	↘
6:	8.7	↑
7:	9.2	↑
8:	7.7	↑
9:	8.2	→
10:	6.9	→
Serie		82 (0x)
Total		167 (1x)

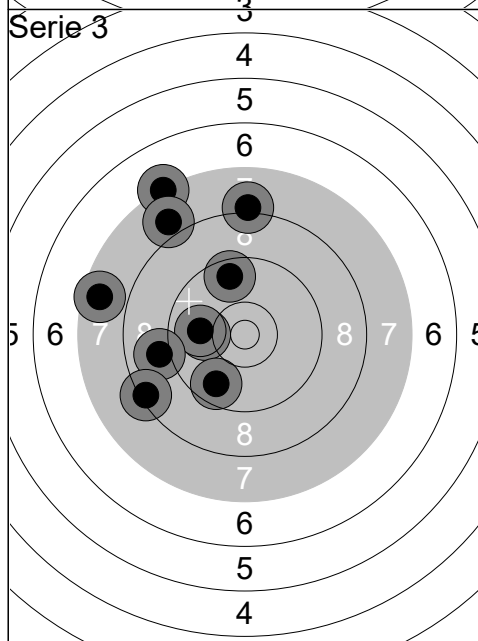

1:	10.1	←
2:	7.2	↗
3:	7.9	↖
4:	9.7	↘
5:	10.0	←
6:	8.1	↑
7:	9.6	↑
8:	7.6	←
9:	9.0	←
10:	8.4	↖
Serie		84 (0x)
Total		251 (1x)

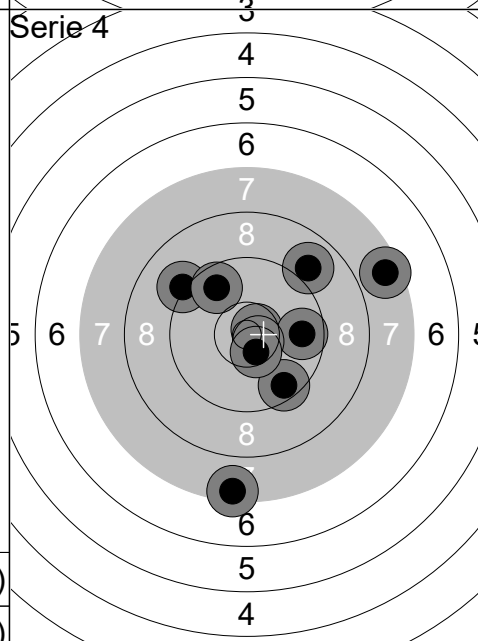

1:	10.7x	↗
2:	9.2	↖
3:	7.6	→
4:	9.7	↖
5:	9.7	→
6:	10.7x	↘
7:	7.5	↘
8:	8.9	↗
9:	9.6	↘
10:	10.5x	↘
Serie		88 (3x)
Total		339 (4x)

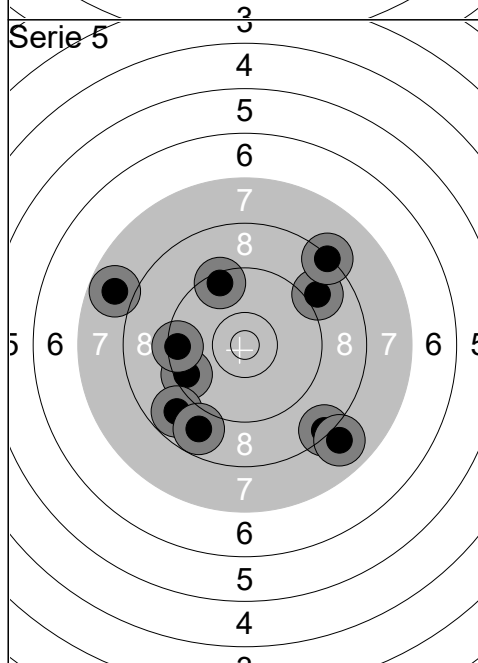

1:	9.5	↖
2:	8.3	↘
3:	9.0	↗
4:	9.5	←
5:	8.8	↖
6:	8.8	↘
7:	9.4	←
8:	7.8	←
9:	8.3	↗
10:	8.0	↘
Serie		83 (0x)
Total		422 (4x)

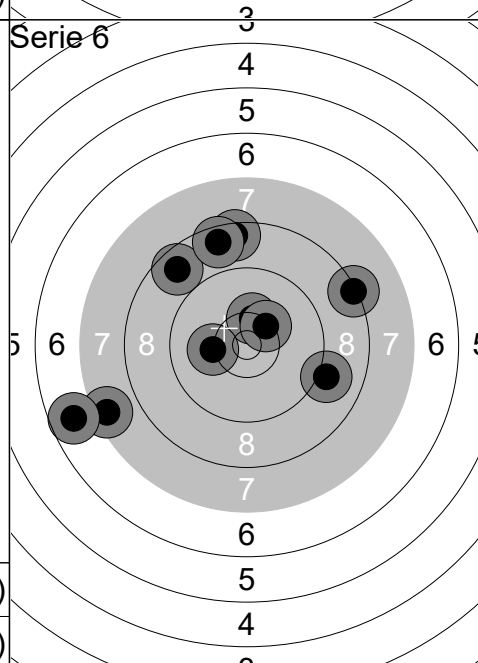

1:	8.6	↖
2:	7.5	←
3:	8.3	→
4:	8.5	↑
5:	10.3	↑
6:	6.8	←
7:	8.6	↑
8:	10.4	↗
9:	9.0	→
10:	10.2	←
Serie		84 (0x)
Total		506 (4x)

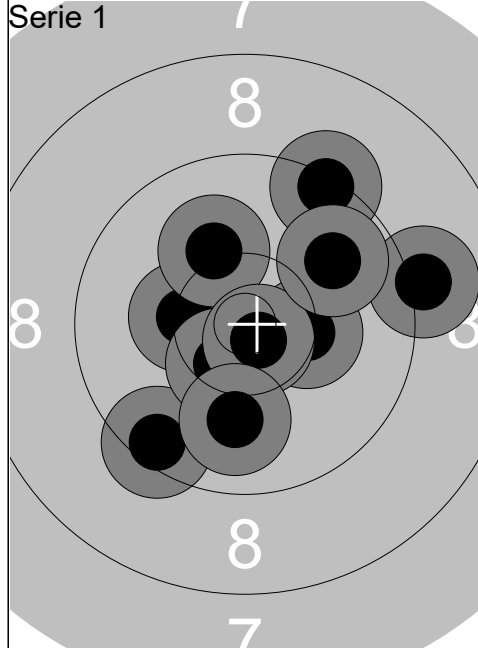

1:	10.3	←
2:	9.5	↙
3:	10.5x	↘
4:	10.1	↑
5:	10.3	→
6:	9.3	↗
7:	10.7x	↘
8:	10.0	↓
9:	9.1	→
10:	9.9	↗
Serie	96	(2x)
Total	96	(2x)

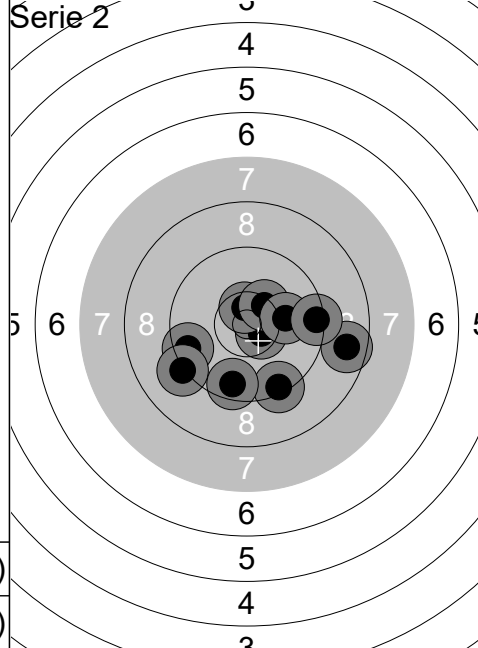

1:	10.6x	↘
2:	9.5	←
3:	8.7	→
4:	10.6x	↑
5:	9.2	↙
6:	9.4	↘
7:	10.4x	↗
8:	10.1	→
9:	9.4	→
10:	9.6	↓
Serie	93	(3x)
Total	189	(5x)

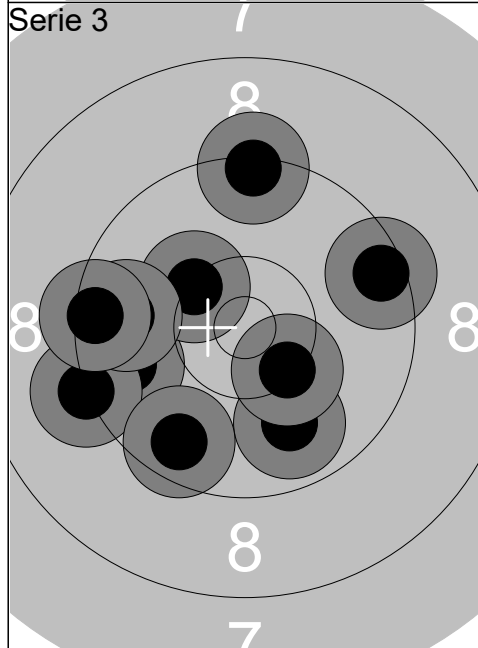

1:	9.7	←
2:	9.2	←
3:	10.3	↖
4:	9.7	←
5:	9.4	←
6:	9.9	↘
7:	9.3	↑
8:	9.6	↘
9:	9.5	→
10:	10.3	↘
Serie	92	(0x)
Total	281	(5x)

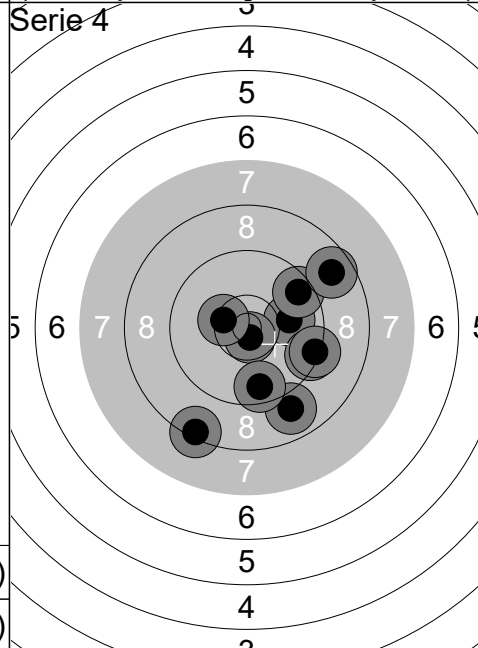

1:	8.3	↘
2:	10.0	→
3:	10.7x	↘
4:	10.4x	↖
5:	9.6	↗
6:	9.4	→
7:	8.7	↗
8:	8.9	↘
9:	9.3	→
10:	9.6	↓
Serie	90	(2x)
Total	371	(7x)

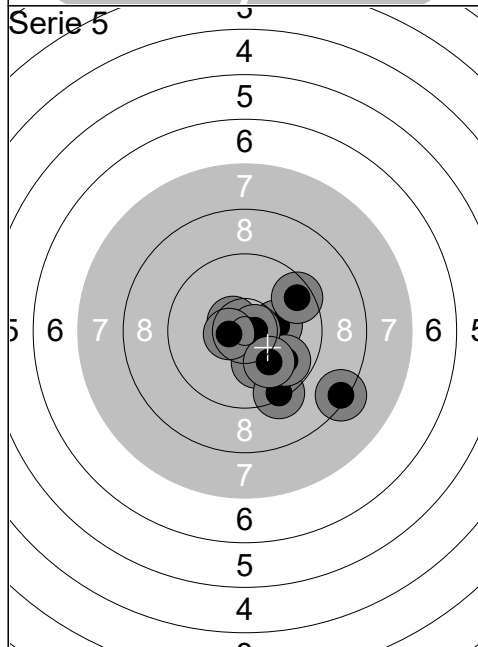

1:	10.6x	↖
2:	10.2	↘
3:	10.2	→
4:	9.4	↘
5:	9.8	↘
6:	8.4	↘
7:	10.7x	→
8:	9.6	↗
9:	10.6x	←
10:	10.1	↘
Serie	95	(3x)
Total	466	(10x)

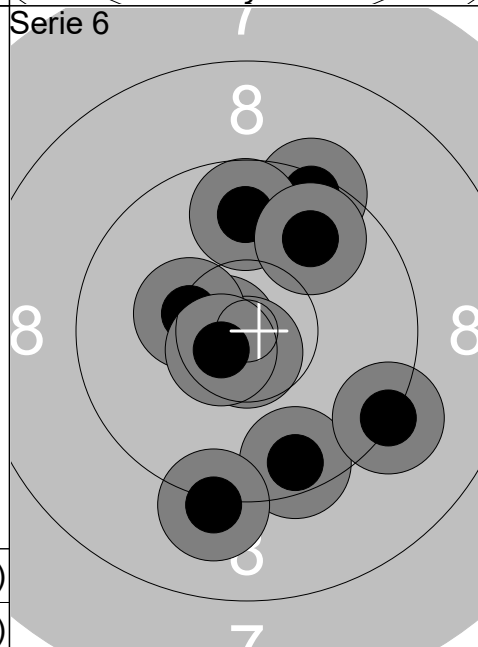

1:	10.7x	←
2:	10.7x	↓
3:	10.3	←
4:	9.4	↗
5:	9.5	↘
6:	9.8	↑
7:	9.2	↓
8:	10.6x	↖
9:	9.3	↘
10:	9.8	↗
Serie	94	(3x)
Total	560	(13x)

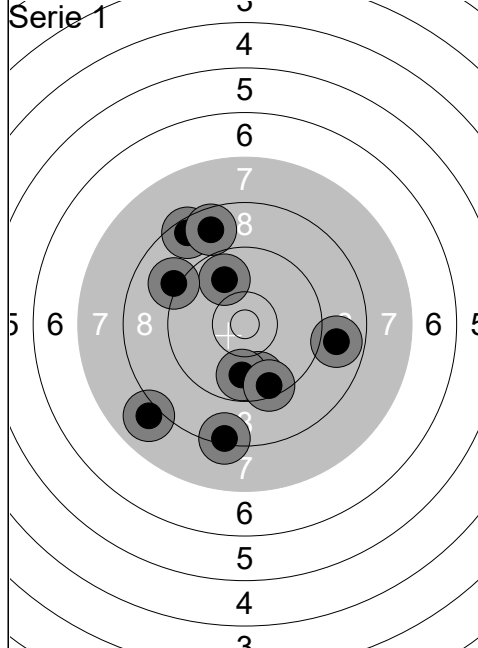

1:	9.8	↗
2:	9.1	↖
3:	8.9	→
4:	9.7	↓
5:	9.8	↓
6:	8.4	↓
7:	8.0	↙
8:	8.5	↗
9:	9.5	↓
10:	8.7	↗
Serie	85 (0x)	
Total	85 (0x)	

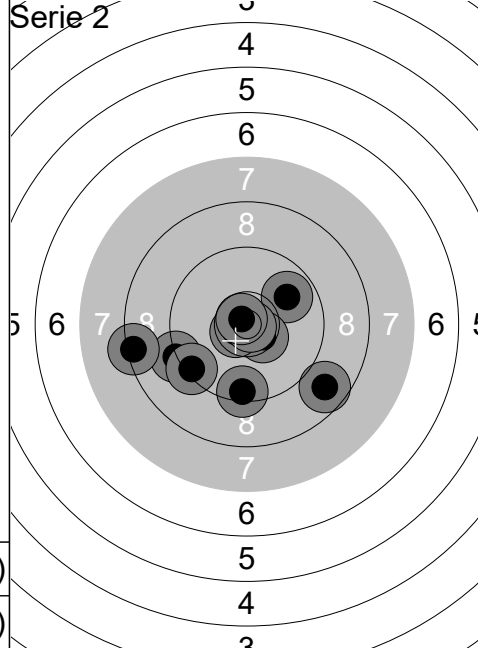

1:	9.9	↗
2:	9.4	↓
3:	10.5x	↘
4:	8.7	↘
5:	10.6x	↙
6:	9.2	↙
7:	10.8x	↘
8:	8.4	↙
9:	10.8x	↗
10:	9.4	↙
Serie	92 (4x)	
Total	177 (4x)	

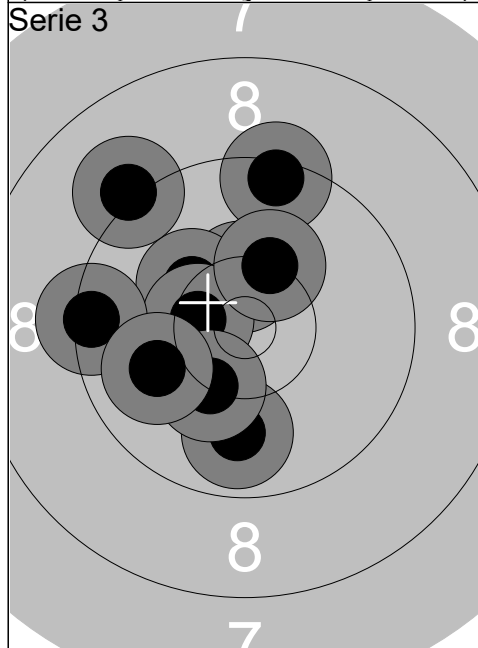

1:	9.9	↓
2:	10.4x	↑
3:	10.2	↖
4:	9.4	↑
5:	10.5x	↙
6:	9.1	↖
7:	10.3	↓
8:	9.4	↙
9:	10.0	↙
10:	10.3	↗
Serie	96 (2x)	
Total	273 (6x)	

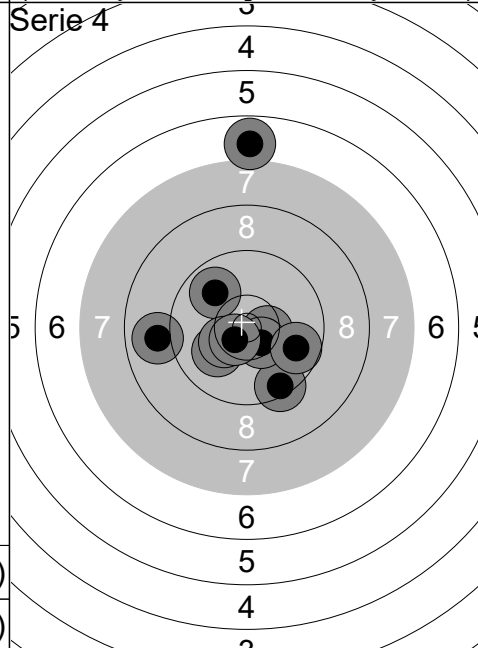

1:	9.5	↓
2:	10.5x	→
3:	10.5x	↘
4:	8.9	↙
5:	9.8	→
6:	6.9	↑
7:	10.1	↙
8:	9.9	↖
9:	10.3	↙
10:	10.6x	↙
Serie	91 (3x)	
Total	364 (9x)	

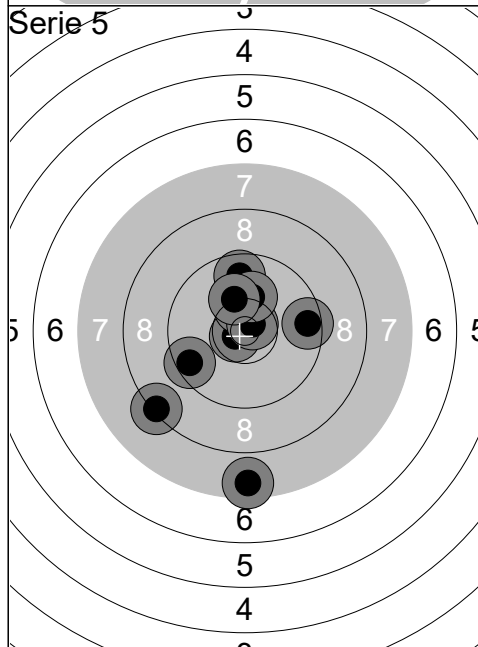

1:	9.5	→
2:	10.7x	↙
3:	9.5	↙
4:	10.4x	↑
5:	9.7	↑
6:	10.7x	↗
7:	7.6	↓
8:	8.3	↙
9:	10.2	↑
10:	10.2	↑
Serie	92 (3x)	
Total	456 (12x)	

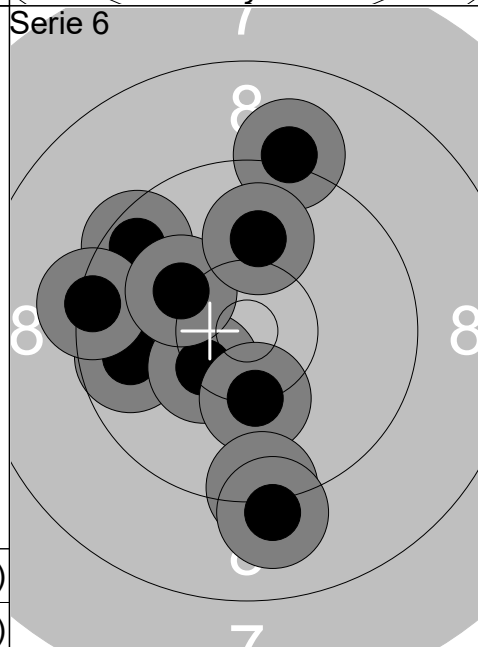

1:	9.7	↙
2:	9.6	↖
3:	10.4x	↙
4:	10.3	↓
5:	9.4	↓
6:	9.4	↙
7:	9.1	↑
8:	9.1	↓
9:	10.2	↖
10:	10.0	↑
Serie	94 (1x)	
Total	550 (13x)	

Skjutlag 2	Tavla 40	Åsa Edvinsson			
1 Luft		Umeå Pistolskytteklubb	D 3		
21.01.2024		Vinterträffen 2024	Umeå skytteallians		
Serie 1		1: 9.8 ↑ 2: 10.1 ↓ 3: 10.8x ↖ 4: 9.2 ↗ 5: 9.2 ← 6: 10.1 ← 7: 8.8 ↗ 8: 9.9 → 9: 8.0 ↘ 10: 10.5x ↘ Serie 92 (2x) Total 92 (2x)	Serie 2		1: 9.8 ↑ 2: 10.2 ↑ 3: 9.4 ↖ 4: 10.1 ← 5: 10.3 ← 6: 10.1 ↗ 7: 10.3 ↓ 8: 8.8 ↑ 9: 10.0 ↗ 10: 9.6 ↗ Serie 95 (0x) Total 187 (2x)
Serie 3		1: 9.8 ↑ 2: 9.5 ↘ 3: 10.1 ↓ 4: 9.2 → 5: 9.1 ↓ 6: 9.1 ↓ 7: 10.2 ← 8: 9.8 ↘ 9: 9.1 ↑ 10: 10.4 ↑ Serie 93 (0x) Total 280 (2x)	Serie 4		1: 9.8 ↑ 2: 9.5 ↖ 3: 10.0 → 4: 10.4x ↖ 5: 9.4 ↓ 6: 10.1 ↓ 7: 9.6 ↑ 8: 10.1 ↗ 9: 10.3 ↓ 10: 10.4x ↓ Serie 96 (2x) Total 376 (4x)
Serie 5		1: 10.2 ↑ 2: 10.5x ↘ 3: 9.8 ← 4: 9.6 ↗ 5: 10.0 ↓ 6: 9.1 → 7: 9.9 ↑ 8: 10.3 → 9: 10.6x ↖ 10: 8.4 ↓ Serie 94 (2x) Total 470 (6x)	Serie 6		1: 9.5 ← 2: 9.6 → 3: 10.0 ↗ 4: 9.2 ↖ 5: 8.0 ↑ 6: 9.1 ← 7: 10.1 ↗ 8: 9.0 ↑ 9: 9.7 ↓ 10: 10.0 ↖ Serie 92 (0x) Total 562 (6x)

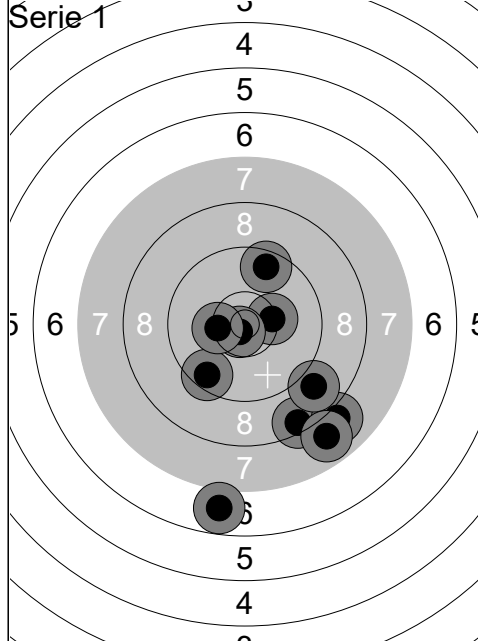

1:	8.5	↘
2:	6.8	↘
3:	9.5	↘
4:	9.6	↗
5:	8.0	↘
6:	10.3	→
7:	8.9	↘
8:	10.7x	↘
9:	7.9	↘
10:	10.3	←
Serie		85 (1x)
Total		85 (1x)

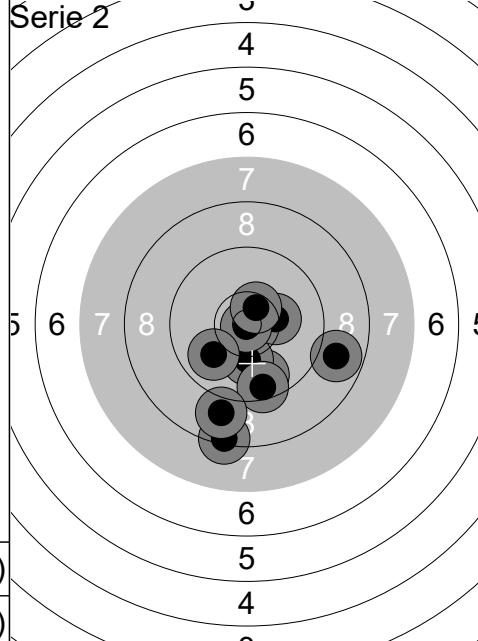

1:	8.4	↘
2:	8.8	→
3:	9.8	↘
4:	10.2	↘
5:	10.3	→
6:	10.9x	↘
7:	9.5	↘
8:	8.9	↘
9:	10.5x	↗
10:	9.9	↙
Serie		91 (2x)
Total		176 (3x)

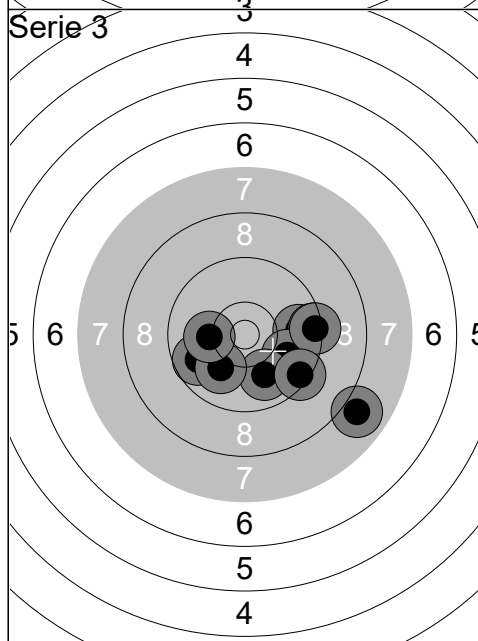

1:	9.7	→
2:	9.8	←
3:	9.4	→
4:	7.9	↘
5:	9.9	→
6:	9.4	→
7:	9.9	↘
8:	9.4	↘
9:	10.0	↘
10:	10.1	←
Serie		90 (0x)
Total		266 (3x)

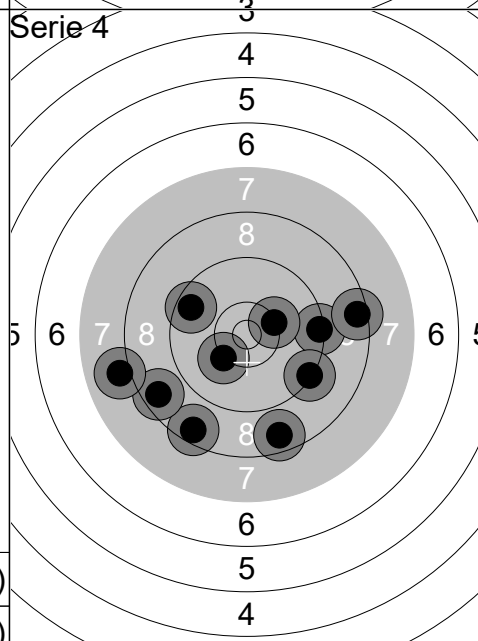

1:	9.3	→
2:	10.2	↙
3:	8.4	→
4:	8.6	↘
5:	9.5	←
6:	10.3	→
7:	9.3	↘
8:	8.5	↘
9:	8.6	←
10:	8.0	←
Serie		87 (0x)
Total		353 (3x)

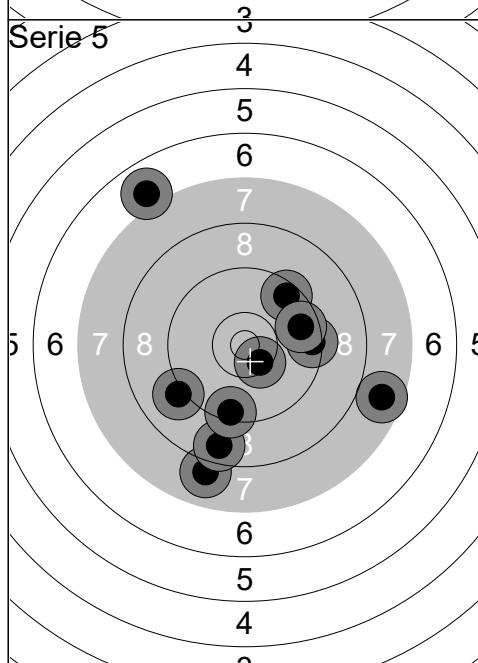

1:	6.9	↗
2:	8.0	↘
3:	8.6	↘
4:	9.4	↘
5:	9.5	↗
6:	10.4x	↘
7:	9.4	→
8:	9.6	→
9:	7.7	→
10:	9.1	↙
Serie		84 (1x)
Total		437 (4x)

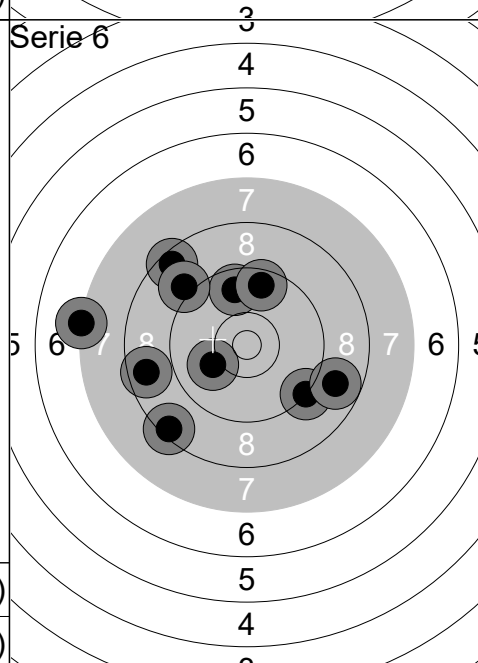

1:	7.2	←
2:	8.5	↖
3:	8.6	←
4:	10.1	↙
5:	8.4	↘
6:	9.2	↘
7:	9.7	↗
8:	9.0	↖
9:	8.8	→
10:	9.6	↗
Serie		85 (0x)
Total		522 (4x)

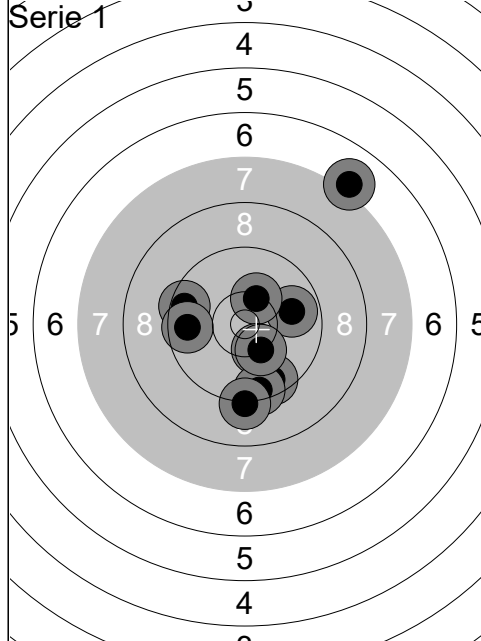

1:	9.9	→
2:	10.3	↗
3:	10.3	↘
4:	7.1	↗
5:	9.6	↘
6:	9.4	↘
7:	9.5	←
8:	9.2	↘
9:	9.7	←
10:	10.3	↘
Serie		91 (0x)
Total		91 (0x)

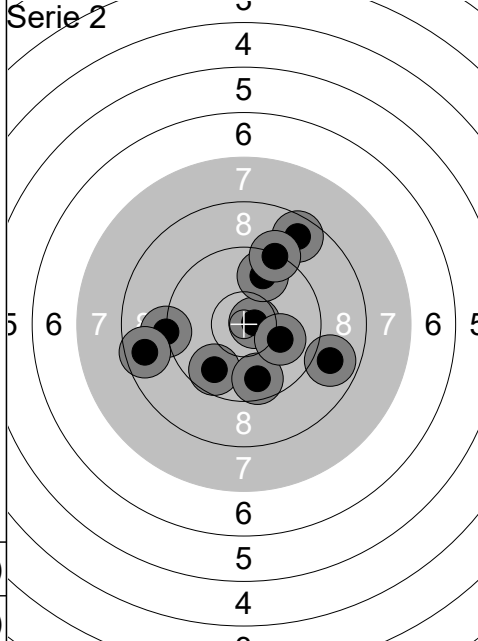

1:	9.7	↙
2:	9.7	↘
3:	10.7x	→
4:	9.2	←
5:	8.6	←
6:	8.7	↗
7:	9.8	↗
8:	9.3	↗
9:	10.1	→
10:	8.9	→
Serie		89 (1x)
Total		180 (1x)

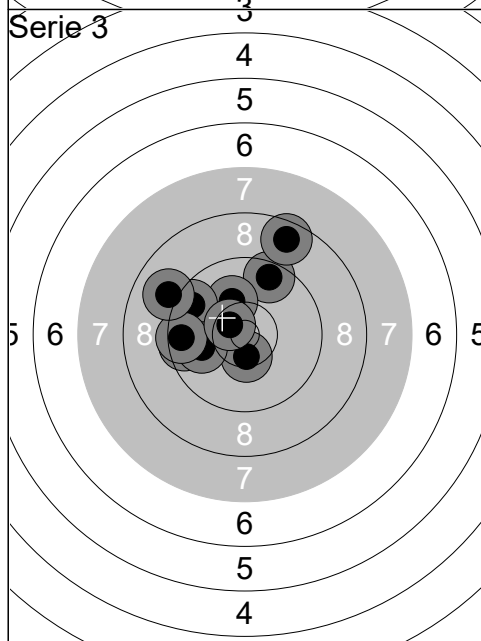

1:	10.5x	↘
2:	9.5	↗
3:	10.2	↗
4:	9.6	←
5:	9.6	↙
6:	8.6	↗
7:	9.9	←
8:	9.5	←
9:	10.5x	↙
10:	9.0	↙
Serie		92 (2x)
Total		272 (3x)

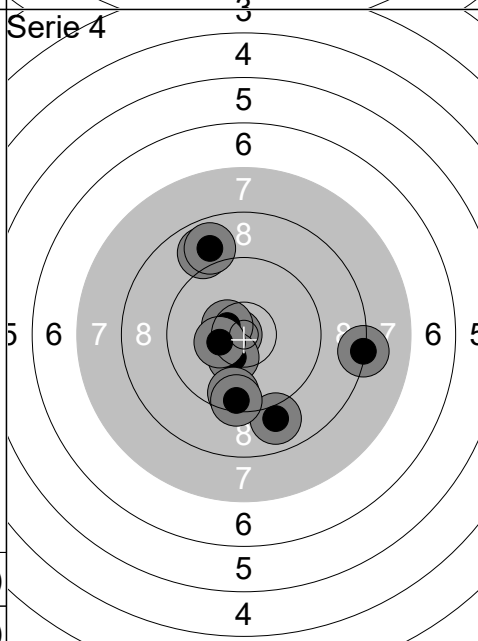

1:	10.8x	←
2:	10.5x	↙
3:	8.9	↘
4:	10.4x	↘
5:	9.6	↘
6:	10.4x	←
7:	9.5	↘
8:	8.9	↗
9:	8.9	↗
10:	8.3	→
Serie		90 (4x)
Total		362 (7x)

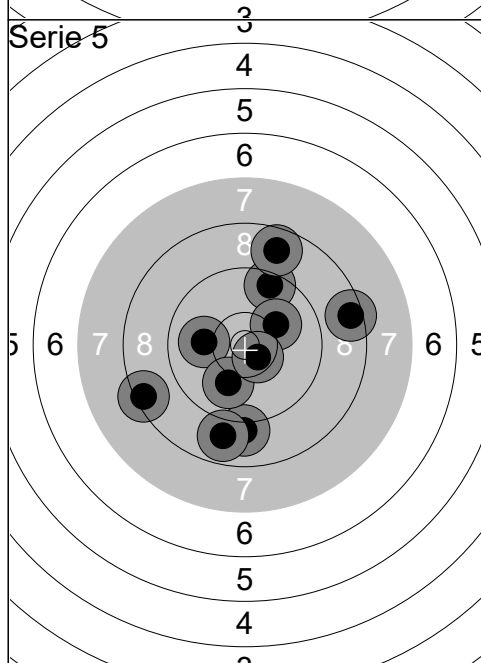

1:	8.5	→
2:	10.0	←
3:	8.4	←
4:	9.5	↗
5:	9.0	↘
6:	10.1	↗
7:	8.7	↗
8:	10.0	↘
9:	10.6x	↘
10:	8.9	↘
Serie		90 (1x)
Total		452 (8x)

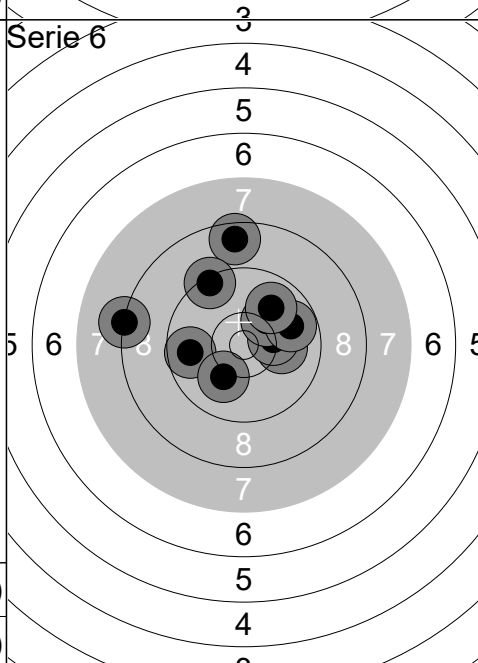

1:	10.1	→
2:	10.3	→
3:	9.8	←
4:	8.2	←
5:	10.2	↗
6:	9.8	→
7:	9.9	↗
8:	8.6	↑
9:	10.1	↘
10:	9.4	↙
Serie		92 (0x)
Total		544 (8x)

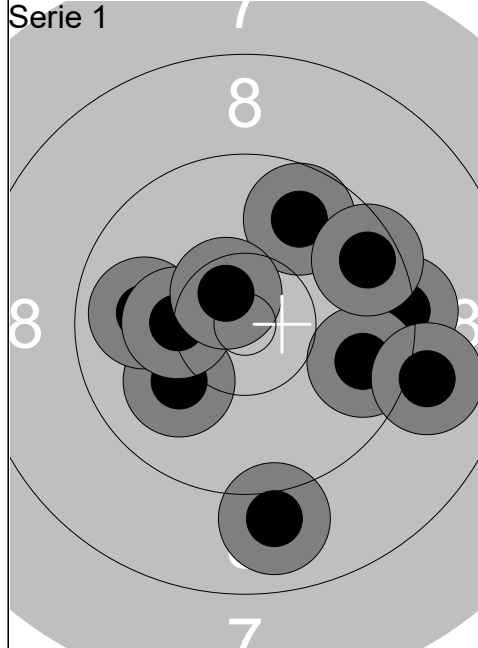

1:	9.3	→
2:	10.1	↙
3:	9.7	→
4:	9.0	↓
5:	9.7	↗
6:	9.9	←
7:	9.5	↗
8:	9.0	→
9:	10.3	←
10:	10.6x	↖
Serie	93	(1x)
Total	93	(1x)

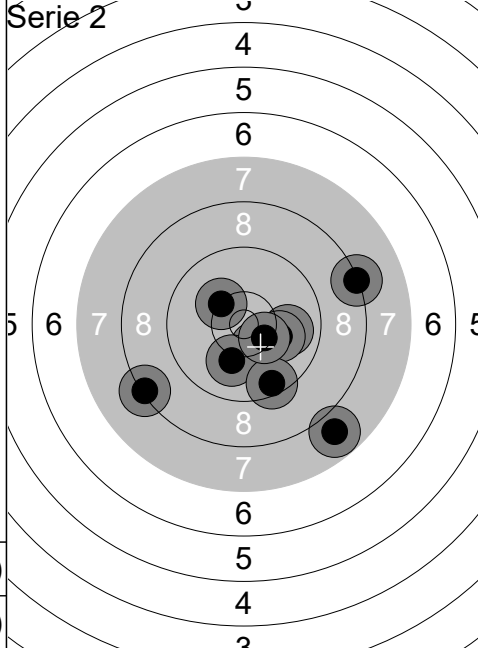

1:	10.0	→
2:	8.3	↗
3:	10.4x	↘
4:	8.3	↙
5:	10.3	↗
6:	7.8	↘
7:	10.1	↓
8:	10.1	→
9:	9.5	↓
10:	10.4x	↘
Serie	92	(2x)
Total	185	(3x)

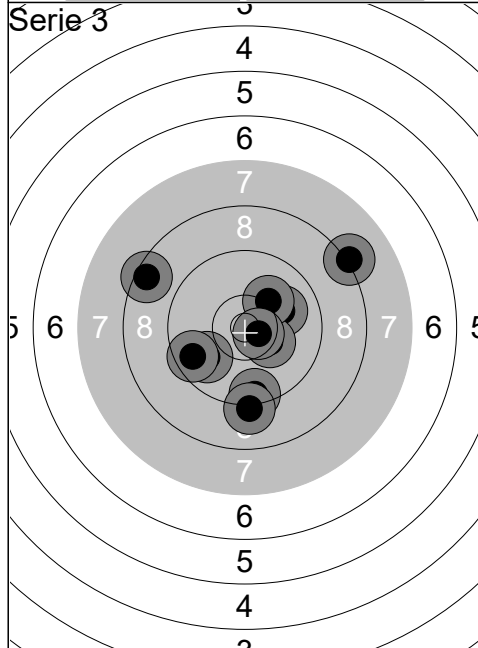

1:	10.0	↗
2:	10.3	↘
3:	9.9	↙
4:	10.2	↗
5:	9.4	↓
6:	8.5	←
7:	9.1	↓
8:	8.2	↗
9:	9.6	←
10:	10.6x	↘
Serie	92	(1x)
Total	277	(4x)

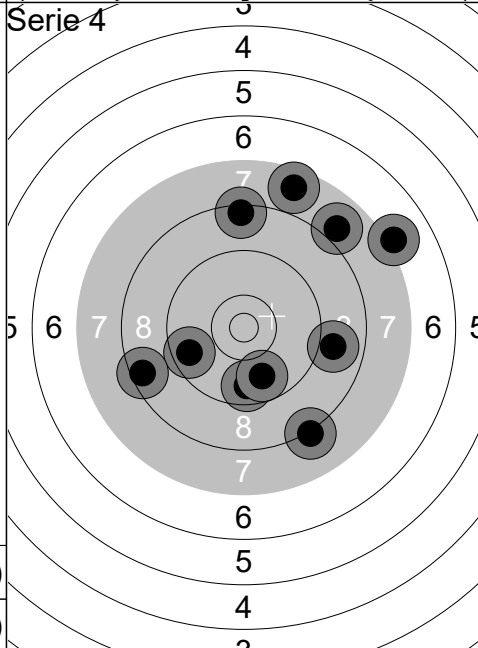

1:	8.4	↑
2:	7.6	↗
3:	9.6	↓
4:	8.9	→
5:	8.2	↘
6:	9.6	←
7:	7.9	↗
8:	9.8	↓
9:	8.5	←
10:	7.1	↗
Serie	80	(0x)
Total	357	(4x)

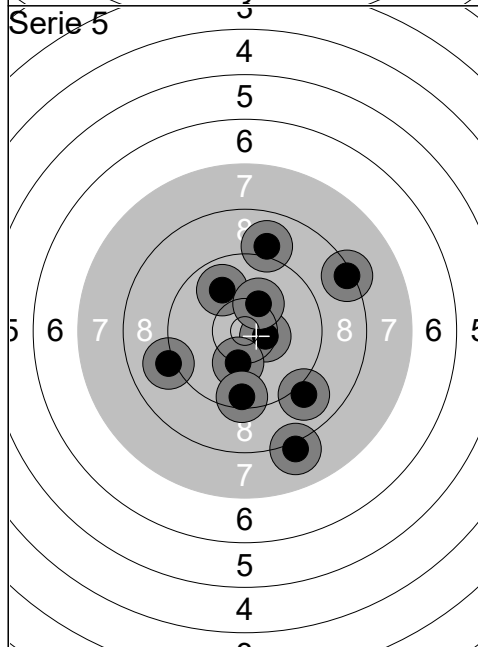

1:	9.9	↗
2:	9.0	↘
3:	10.5x	→
4:	8.4	↗
5:	9.0	↗
6:	10.2	↓
7:	9.5	↓
8:	10.3	↗
9:	9.1	←
10:	8.1	↓
Serie	91	(1x)
Total	448	(5x)

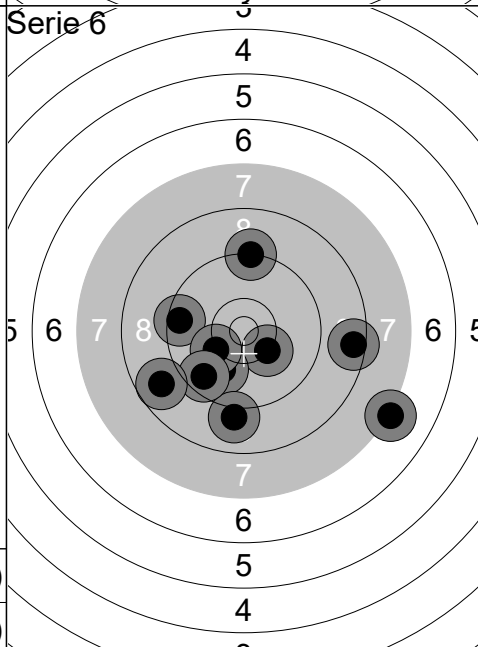

1:	9.5	←
2:	10.3	↘
3:	10.0	↘
4:	10.2	↙
5:	9.2	↑
6:	9.0	↓
7:	9.6	↙
8:	8.8	←
9:	8.5	→
10:	7.2	↘
Serie	89	(0x)
Total	537	(5x)

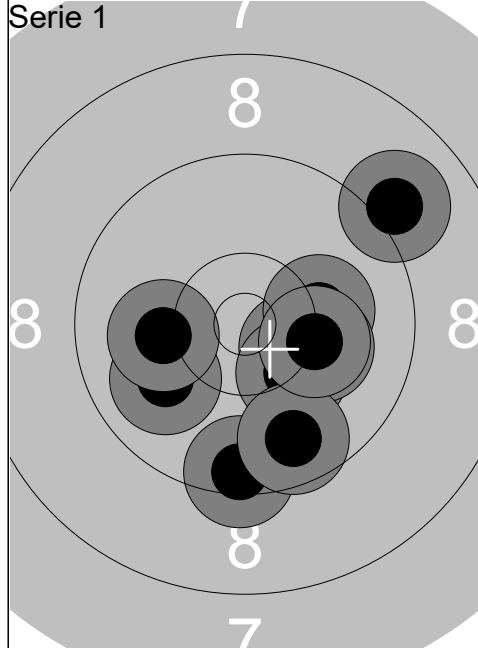

1:	9.0	↗
2:	9.5	↓
3:	10.0	↙
4:	10.1	←
5:	10.4x	→
6:	10.3	↘
7:	10.2	→
8:	10.2	→
9:	9.7	↘
10:	10.2	→
Serie	97	(1x)
Total	97	(1x)

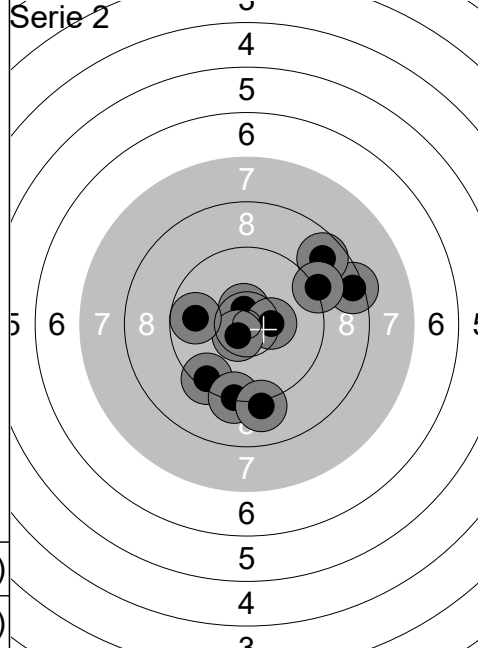

1:	8.5	↗
2:	9.4	↘
3:	8.7	↗
4:	10.6x	↖
5:	10.4x	→
6:	9.2	↗
7:	9.3	↓
8:	10.6x	↘
9:	9.1	↓
10:	9.8	←
Serie	91	(3x)
Total	188	(4x)

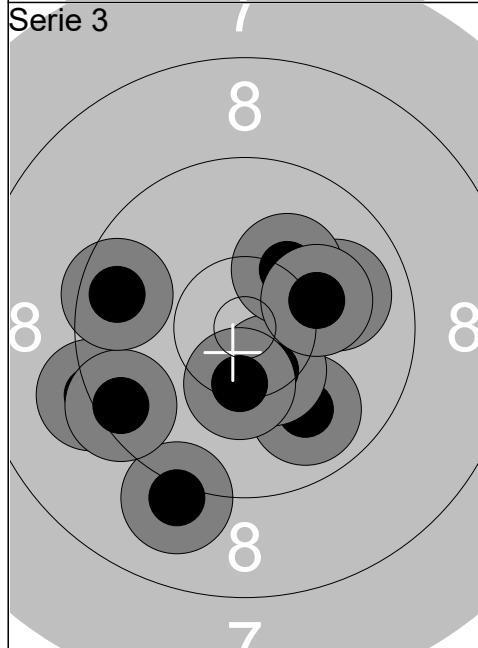

1:	10.0	↗
2:	9.3	↙
3:	9.9	↘
4:	10.4x	↘
5:	9.1	↘
6:	10.2	↗
7:	10.4x	↘
8:	9.5	↙
9:	9.6	↙
10:	10.2	↗
Serie	95	(2x)
Total	283	(6x)

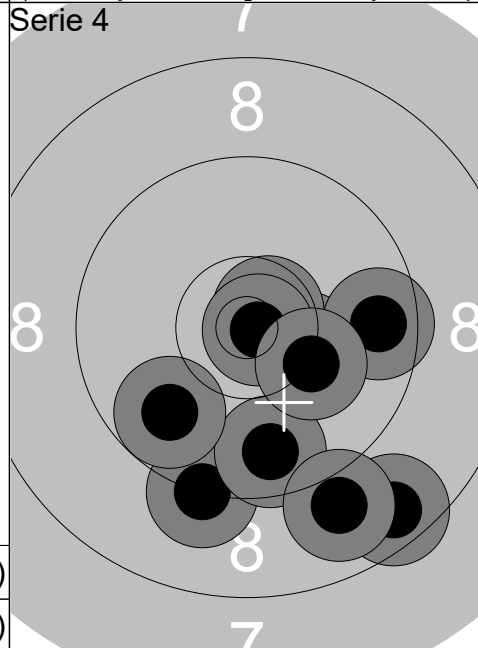

1:	8.6	↘
2:	10.3	→
3:	9.2	↘
4:	10.7x	↗
5:	10.8x	→
6:	9.7	↘
7:	8.9	↘
8:	9.6	→
9:	9.8	↘
10:	10.2	↘
Serie	92	(2x)
Total	375	(8x)

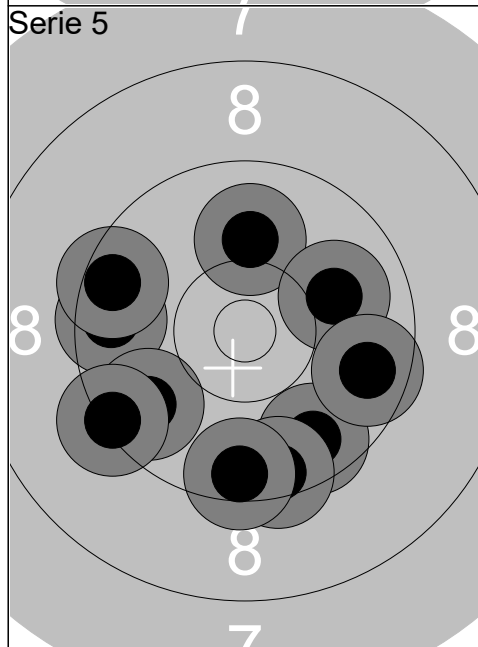

1:	10.0	↑
2:	9.6	←
3:	10.0	→
4:	9.7	↘
5:	9.7	↙
6:	9.5	↙
7:	9.3	↙
8:	9.5	↘
9:	9.5	↘
10:	9.6	→
Serie	92	(0x)
Total	467	(8x)

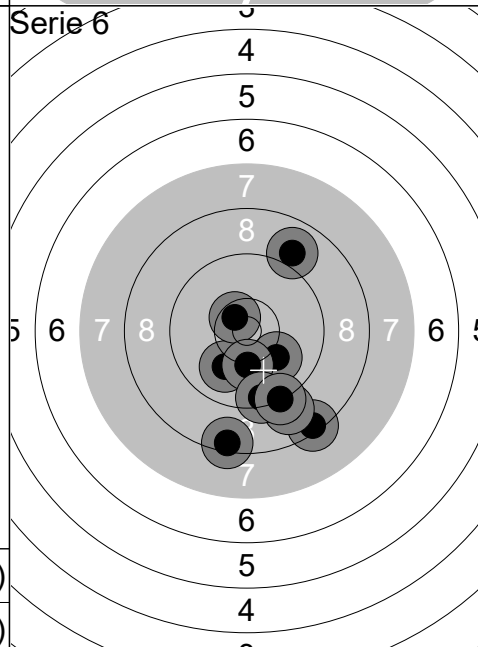

1:	8.9	↗
2:	10.0	↘
3:	8.4	↘
4:	10.1	↘
5:	8.4	↘
6:	9.0	↘
7:	10.5x	↗
8:	10.2	↓
9:	9.4	↘
10:	9.3	↘
Serie	91	(1x)
Total	558	(9x)

Skjutlag 3	Tavla 40	Lars Edvinsson	
1 Luft		Umeå Pistolskytteklubb	Herr
21.01.2024		Vinterträffen 2024	Umeå skytteallians
Serie 1		1: 9.6 ↗ 2: 10.4x ↓ 3: 9.8 → 4: 9.7 ↗ 5: 9.5 → 6: 10.6x ← 7: 9.6 → 8: 10.3 ↓ 9: 9.9 → 10: 10.1 ← Serie 94 (2x) Total 94 (2x)	Serie 2
Serie 3		1: 10.9x ↓ 2: 9.8 ↓ 3: 9.3 ↓ 4: 9.5 ↗ 5: 10.1 ↑ 6: 10.8x → 7: 10.8x ← 8: 9.6 ← 9: 9.3 ↓ 10: 10.4x ↓ Serie 95 (4x) Total 277 (7x)	Serie 4
Serie 5		1: 9.0 ↓ 2: 9.3 → 3: 10.2 ↑ 4: 10.0 ↓ 5: 10.6x ← 6: 10.8x → 7: 10.6x ↓ 8: 10.0 ← 9: 10.1 ↓ 10: 9.4 ↓ Serie 97 (3x) Total 469 (13x)	Serie 6
			1: 7.9 → 2: 9.1 ↑ 3: 9.9 ↗ 4: 9.6 ↓ 5: 9.7 ↗ 6: 10.4x → 7: 9.8 ↙ 8: 8.0 ← 9: 9.9 ↓ 10: 9.4 → Serie 88 (1x) Total 182 (3x)
			1: 9.5 → 2: 10.0 ↗ 3: 9.7 ← 4: 10.5x ↓ 5: 10.4x ↓ 6: 10.8x → 7: 10.3 ↙ 8: 8.7 ↓ 9: 10.1 ← 10: 9.1 ↑ Serie 95 (3x) Total 372 (10x)
			1: 9.3 → 2: 9.8 → 3: 9.2 ↙ 4: 10.5x ↑ 5: 10.3 ↗ 6: 8.7 ← 7: 10.8x → 8: 10.2 ↓ 9: 10.3 ↑ 10: 7.9 ← Serie 92 (2x) Total 561 (15x)