

1:	9.4	➔
2:	8.9	↓
3:	5.9	↙
4:	8.7	↓
5:	10.6x	↓
6:	9.1	➔
7:	10.1	↔
8:	7.4	↓
9:	7.6	↙
10:	9.9	➔
Serie		82 (1x)
Total		82 (1x)

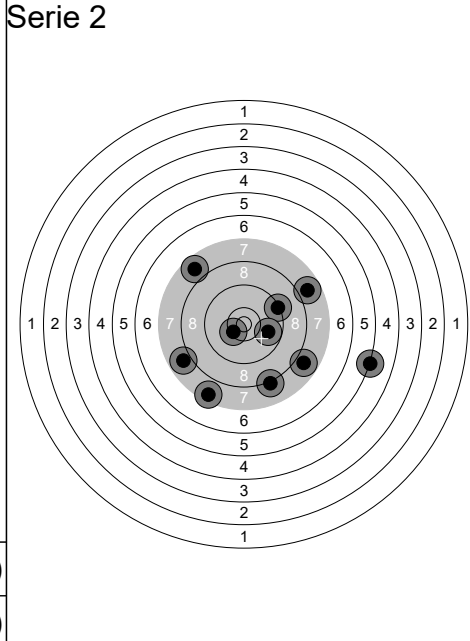

1:	10.4x	↘
2:	7.7	↖
3:	9.3	➔
4:	7.8	➔
5:	9.8	➔
6:	7.5	↓
7:	5.2	➔
8:	8.1	↓
9:	7.9	↙
10:	7.9	↘
Serie		76 (1x)
Total		158 (2x)

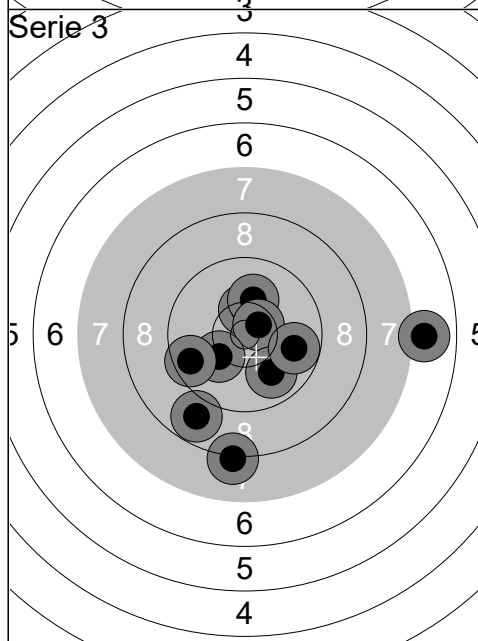

1:	10.4x	↑
2:	10.1	↑
3:	10.6x	➔
4:	10.2	↙
5:	8.8	↓
6:	8.2	↓
7:	6.9	➔
8:	9.9	↓
9:	9.6	↙
10:	9.8	➔
Serie		89 (2x)
Total		247 (4x)

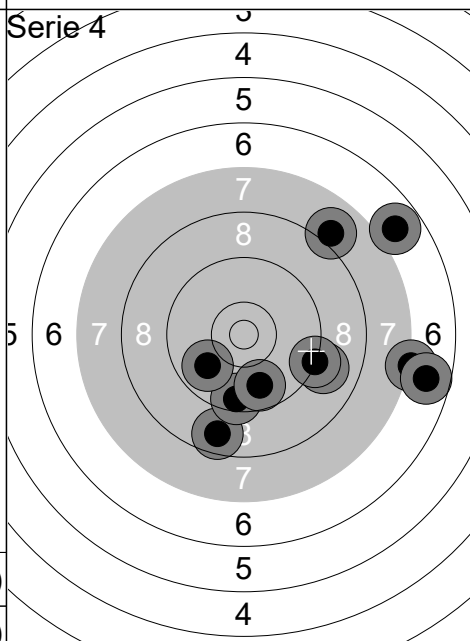

1:	6.8	➔
2:	8.7	↓
3:	7.2	➔
4:	9.0	➔
5:	8.0	↗
6:	6.8	➔
7:	9.5	↓
8:	9.8	↓
9:	9.9	↙
10:	9.3	➔
Serie		80 (0x)
Total		327 (4x)

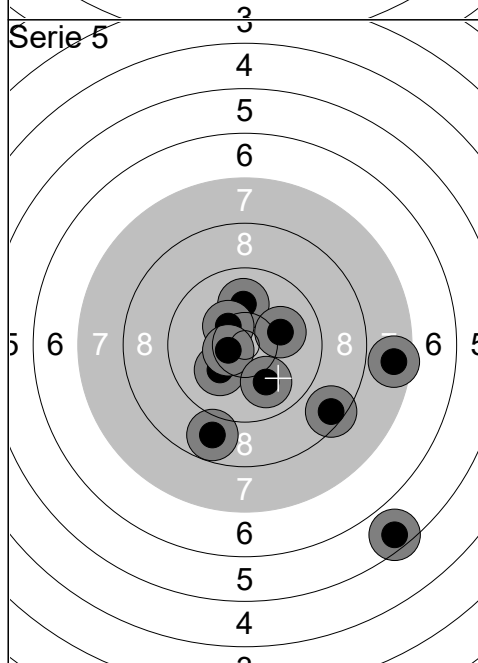

1:	8.8	↓
2:	10.0	↑
3:	10.2	↙
4:	8.5	↘
5:	10.4x	↘
6:	7.6	➔
7:	10.1	➔
8:	10.6x	↔
9:	10.0	↓
10:	5.6	↘
Serie		88 (2x)
Total		415 (6x)

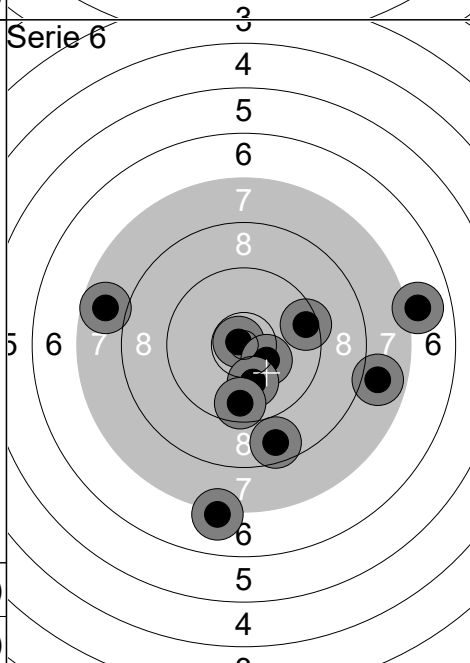

1:	7.8	↔
2:	10.8x	↖
3:	9.5	➔
4:	7.0	➔
5:	7.1	↓
6:	10.3	↘
7:	10.1	↓
8:	9.7	↓
9:	8.7	↓
10:	7.9	➔
Serie		84 (1x)
Total		499 (7x)

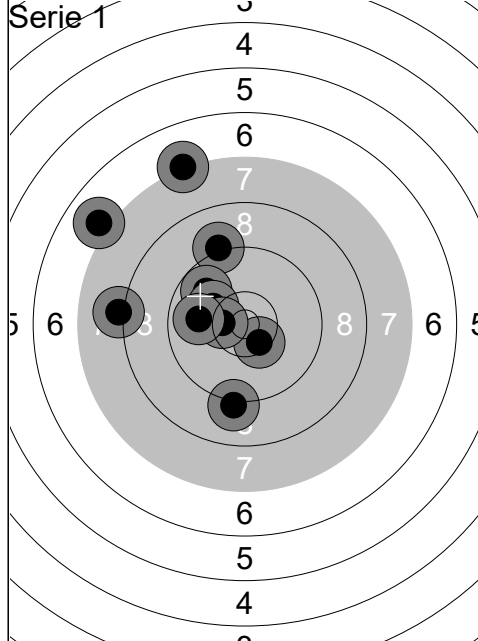

1:	9.1	↓
2:	8.1	←
3:	9.1	↑
4:	10.4x	↘
5:	7.0	↗
6:	9.8	↗
7:	7.2	↑
8:	10.1	←
9:	10.4x	←
10:	9.9	←
Serie		88 (2x)
Total		88 (2x)

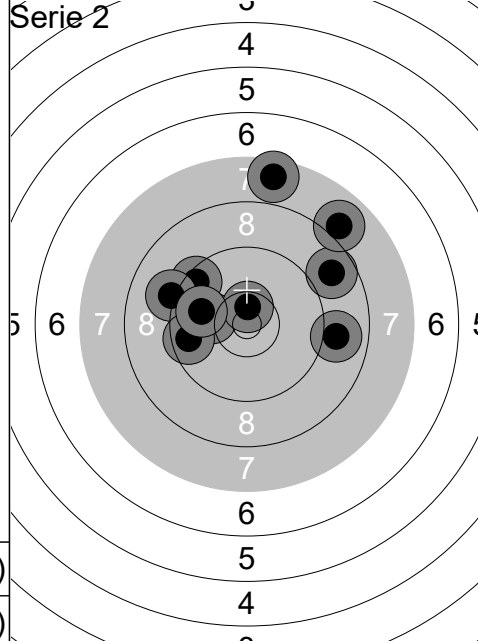

1:	9.5	↖
2:	9.1	←
3:	10.1	←
4:	7.6	↑
5:	9.6	←
6:	8.7	↗
7:	7.9	↗
8:	8.9	→
9:	10.6x	↑
10:	9.9	←
Serie		86 (1x)
Total		174 (3x)

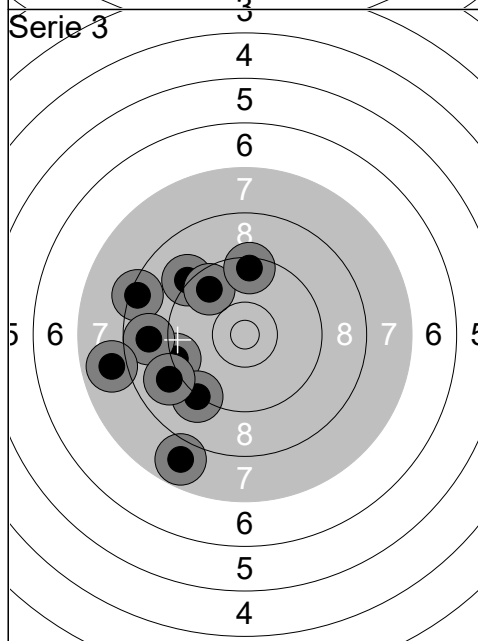

1:	9.3	←
2:	8.4	←
3:	8.8	←
4:	9.2	↗
5:	9.2	↘
6:	7.9	←
7:	9.7	↗
8:	7.8	↘
9:	9.0	←
10:	9.5	↑
Serie		84 (0x)
Total		258 (3x)

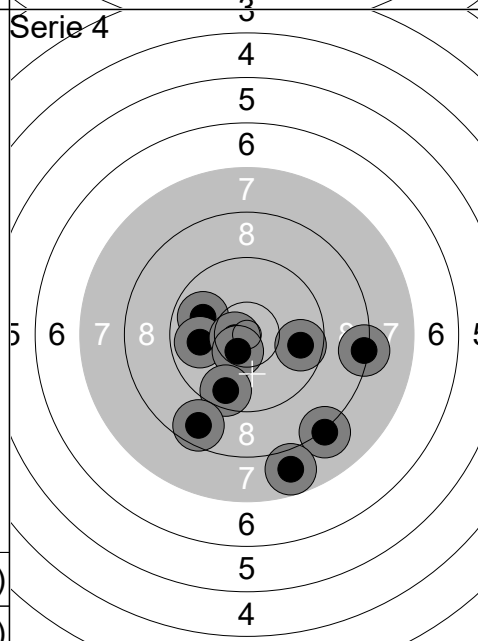

1:	9.9	←
2:	9.9	←
3:	10.7x	←
4:	10.5x	↘
5:	8.2	↘
6:	8.3	→
7:	9.6	↘
8:	8.6	↘
9:	7.8	↘
10:	9.7	→
Serie		87 (2x)
Total		345 (5x)

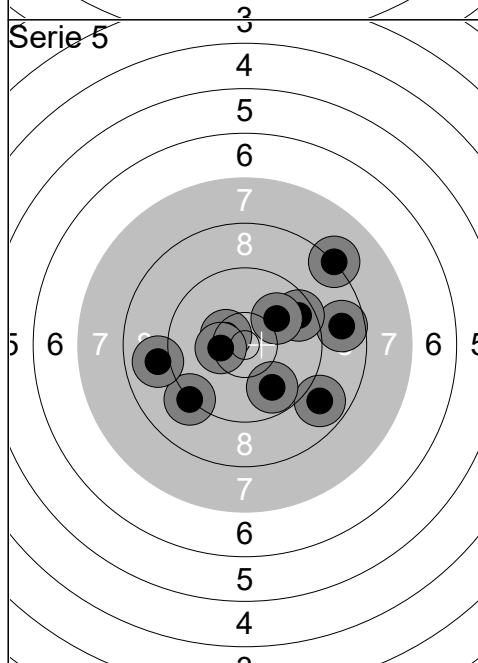

1:	8.9	↘
2:	9.2	↘
3:	8.7	→
4:	10.5x	←
5:	9.8	↘
6:	9.6	↗
7:	10.4x	←
8:	8.2	↗
9:	9.0	←
10:	10.0	↗
Serie		90 (2x)
Total		435 (7x)

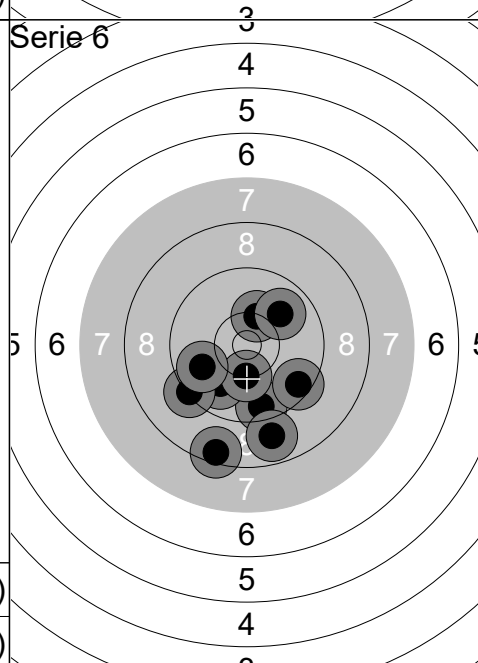

1:	9.5	↘
2:	9.9	↘
3:	10.3	↑
4:	9.3	←
5:	8.5	↘
6:	9.9	↗
7:	9.5	↘
8:	10.3	↓
9:	8.8	↘
10:	9.8	←
Serie		90 (0x)
Total		525 (7x)

Skjutlag	Tavla	Rikard Forell	
1 Luft		Örnsköldsviks Pistolklubb	H 1
11.11.2023	Hösträffen 2023	Umeå skytteallians	
Serie 1		1: 10.1 ↑ 2: 9.8 ↑ 3: 8.3 ↓ 4: 9.4 ↗ 5: 10.0 ↓ 6: 8.5 ← 7: 10.8x ↗ 8: 8.7 ↓ 9: 10.0 ↑ 10: 10.5x ↘	Serie 2
		Serie 92 (2x)	1: 9.4 ↖ 2: 10.3 ↓ 3: 10.3 ↑ 4: 8.6 ↖ 5: 7.6 ↓ 6: 9.6 ↗ 7: 10.3 ↓ 8: 9.8 ← 9: 10.2 ↓ 10: 9.9 ↘
		Total 92 (2x)	Serie 91 (0x)
			Total 183 (2x)
Serie 3		1: 8.8 ← 2: 10.1 ↗ 3: 9.5 ↗ 4: 9.8 ↖ 5: 10.0 ← 6: 9.4 ↖ 7: 10.2 ↓ 8: 10.0 ↖ 9: 9.6 ↗ 10: 7.7 ↓	Serie 4
		Serie 91 (0x)	1: 8.6 ↑ 2: 9.1 ← 3: 9.8 ↑ 4: 9.6 ← 5: 9.1 ↓ 6: 9.8 ↖ 7: 9.8 ↓ 8: 10.3 ↓ 9: 10.5x ↗ 10: 9.8 ↓
		Total 274 (2x)	Serie 91 (1x)
			Total 365 (3x)
Serie 5		1: 7.9 ↘ 2: 10.2 ↓ 3: 8.9 ← 4: 9.4 ← 5: 10.7x ← 6: 9.8 ← 7: 10.4x ↖ 8: 7.1 ← 9: 9.9 ↓ 10: 10.6x ↖	Serie 6
		Serie 89 (3x)	1: 9.6 ← 2: 8.9 ← 3: 9.7 ↓ 4: 8.4 → 5: 8.3 ↓ 6: 10.4x → 7: 8.9 ↗ 8: 9.9 ↑ 9: 8.9 ↓ 10: 10.3 ↗
		Total 454 (6x)	Serie 87 (1x)
			Total 541 (7x)

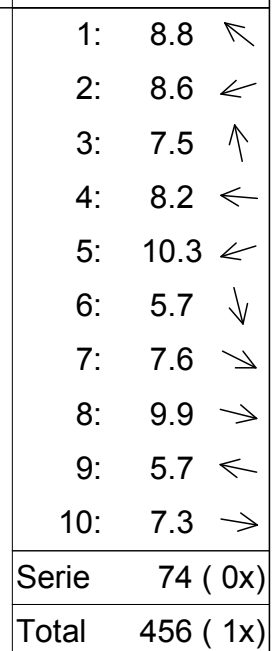
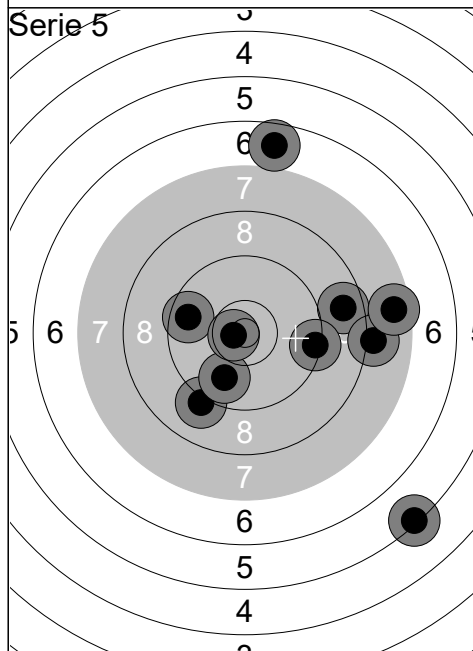
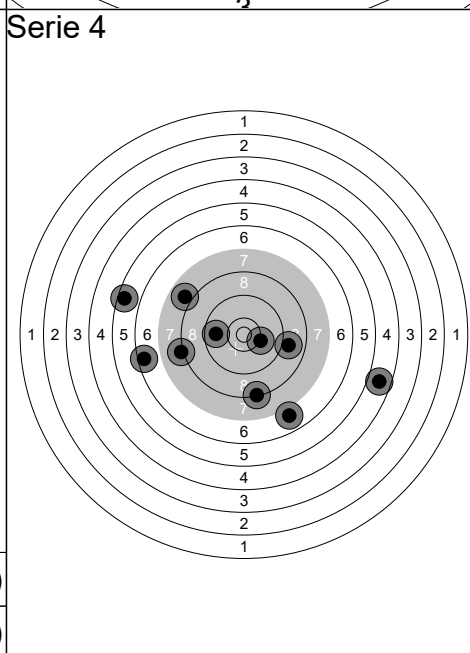
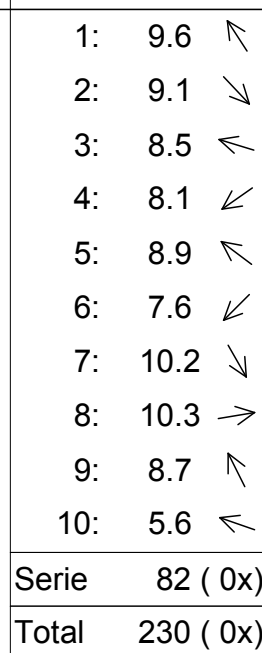
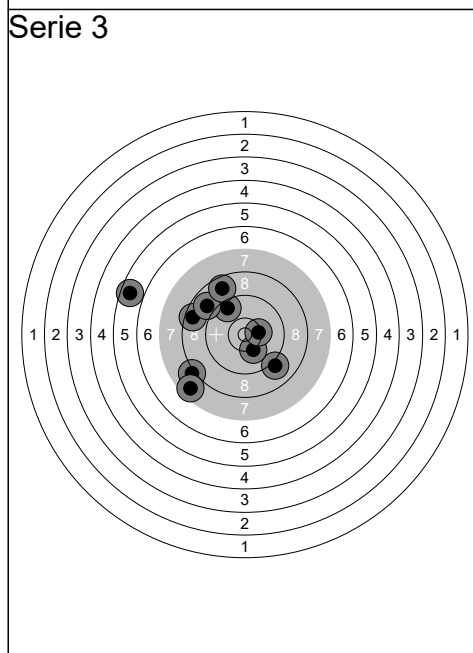
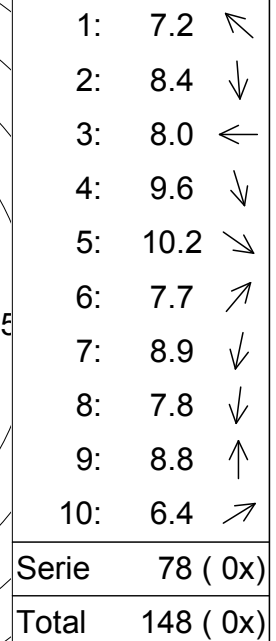
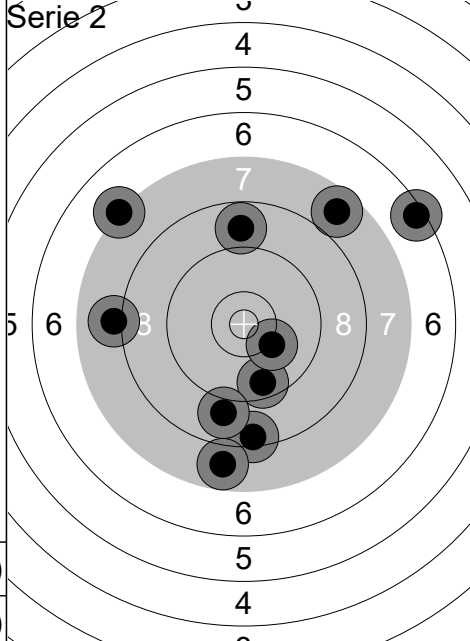
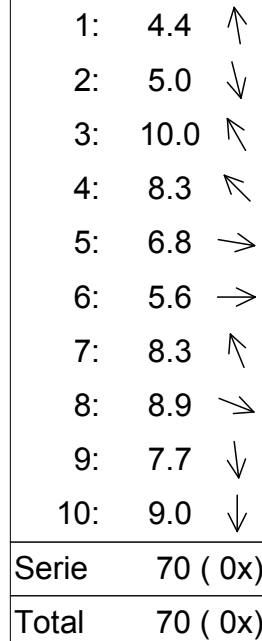
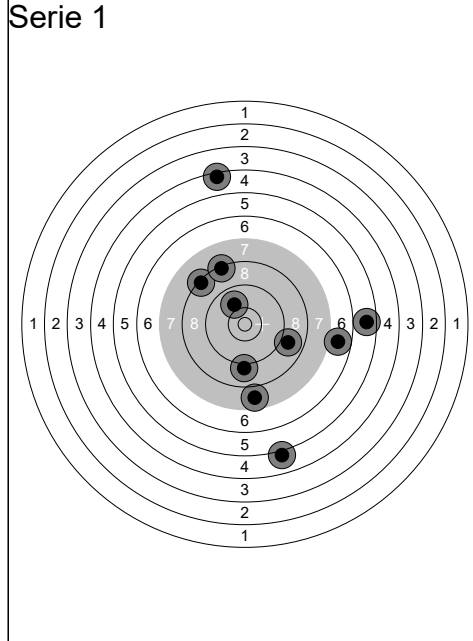

Skjutlag	Tavla	Emelie Fält	
1 Luft		Umeå Pistolskytteklubb	D 3
11.11.2023	Hösträffen 2023	Umeå skytteallians	
Serie 1		Serie 2	
	1: 9.8 ↘ 2: 9.7 ↗ 3: 8.1 ↘ 4: 9.5 → 5: 9.8 ↘ 6: 10.1 ↗ 7: 9.0 → 8: 10.0 ↗ 9: 10.2 ← 10: 9.1 ↗		1: 9.5 ↘ 2: 8.6 ↘ 3: 9.6 ↘ 4: 9.8 ↗ 5: 9.8 → 6: 8.6 ↗ 7: 9.7 ↘ 8: 10.1 ↘ 9: 10.7x → 10: 9.8 ←
	Serie 92 (0x) Total 92 (0x)		Serie 90 (1x) Total 182 (1x)
Serie 3		Serie 4	
	1: 9.5 ↗ 2: 10.3 ↘ 3: 9.7 ↘ 4: 9.5 ↘ 5: 10.0 → 6: 8.8 ↘ 7: 9.4 ↘ 8: 9.9 ↘ 9: 9.6 ← 10: 8.9 ↗		1: 10.3 ↘ 2: 8.5 ↗ 3: 10.8x ↘ 4: 10.7x → 5: 8.7 ← 6: 9.7 → 7: 9.3 → 8: 10.0 ↘ 9: 8.0 ↘ 10: 10.7x ↘
	Serie 90 (0x) Total 272 (1x)		Serie 92 (3x) Total 364 (4x)
Serie 5		Serie 6	
	1: 10.3 ↘ 2: 9.9 ← 3: 9.4 ↗ 4: 9.0 ↘ 5: 9.4 ← 6: 10.2 ↘ 7: 8.8 → 8: 10.2 ↘ 9: 8.9 ← 10: 9.2 ↗		1: 9.3 ← 2: 9.9 ↗ 3: 10.3 ↘ 4: 10.4x → 5: 9.9 → 6: 10.0 ↘ 7: 9.7 ← 8: 9.8 → 9: 10.2 ↗ 10: 10.2 ↗
	Serie 91 (0x) Total 455 (4x)		Serie 95 (1x) Total 550 (5x)

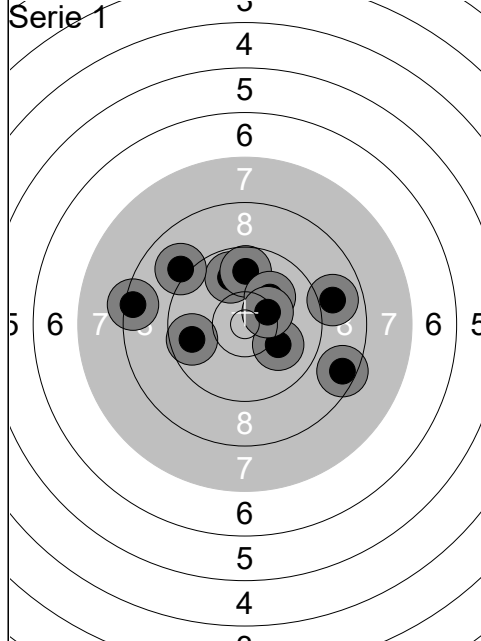

1:	9.7	←
2:	9.8	↑
3:	8.5	→
4:	8.4	←
5:	9.1	↖
6:	9.8	↑
7:	8.9	→
8:	10.1	↗
9:	10.1	↘
10:	10.4x	↗
Serie		90 (1x)
Total		90 (1x)

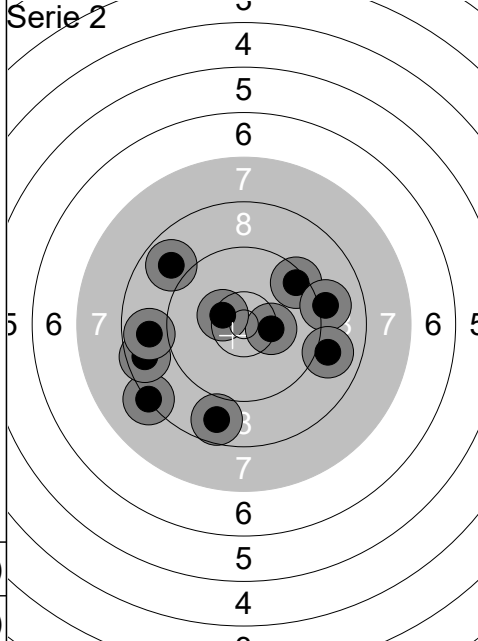

1:	10.3	→
2:	8.3	↙
3:	9.5	↗
4:	8.9	↖
5:	9.1	→
6:	8.6	←
7:	8.7	↓
8:	10.4x	↖
9:	9.0	→
10:	8.8	←
Serie		87 (1x)
Total		177 (2x)

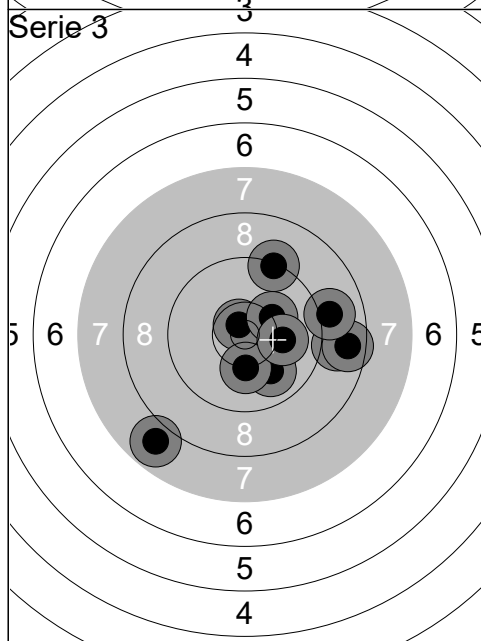

1:	9.3	↗
2:	8.9	→
3:	7.8	↙
4:	8.6	→
5:	10.7x	↗
6:	10.2	↗
7:	9.9	↘
8:	10.2	↓
9:	10.1	→
10:	9.0	→
Serie		90 (1x)
Total		267 (3x)

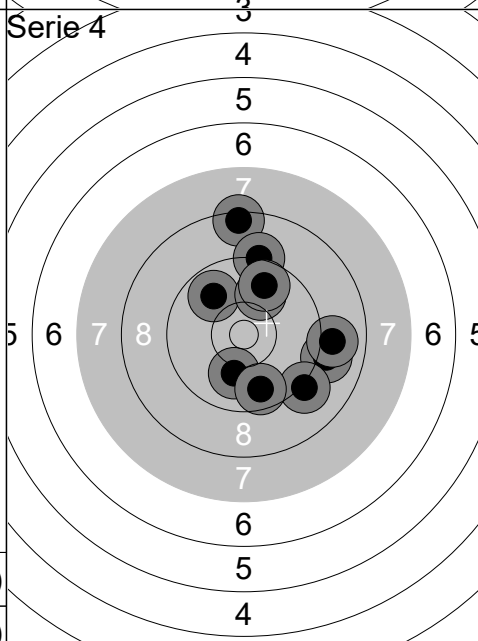

1:	9.8	↖
2:	8.4	↑
3:	9.2	↑
4:	10.0	↗
5:	9.0	→
6:	9.2	↘
7:	10.1	↓
8:	9.0	→
9:	9.7	↓
10:	9.7	↗
Serie		91 (0x)
Total		358 (3x)

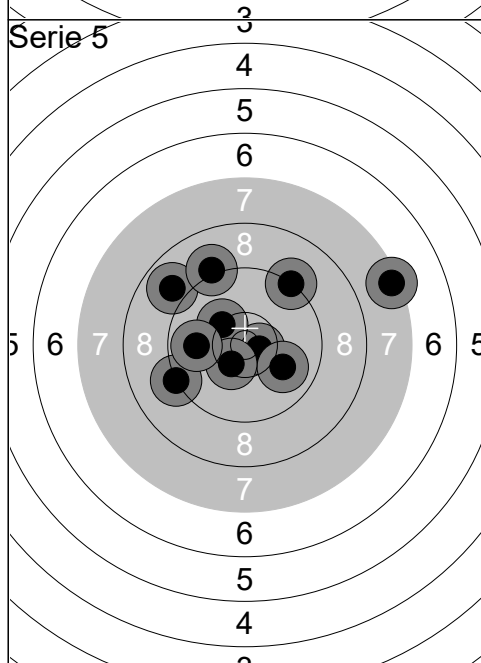

1:	9.2	↗
2:	10.6x	→
3:	8.9	↖
4:	10.0	↘
5:	9.1	↗
6:	10.3	↗
7:	9.2	←
8:	10.4x	↘
9:	7.4	→
10:	9.9	←
Serie		91 (2x)
Total		449 (5x)

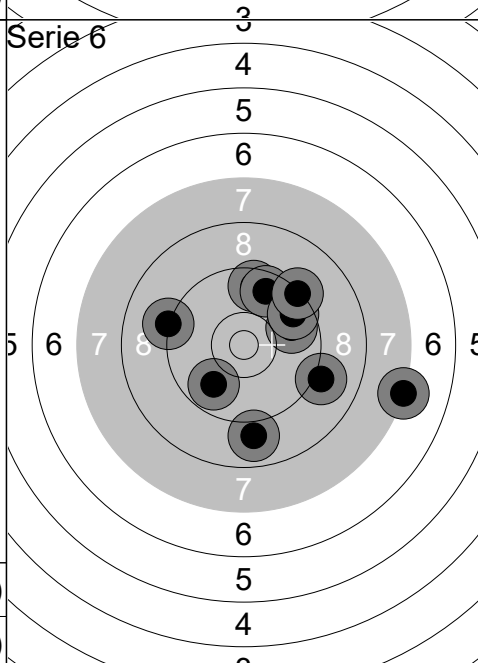

1:	9.6	↑
2:	9.8	→
3:	9.7	↗
4:	9.2	←
5:	9.6	↗
6:	9.1	→
7:	9.8	↙
8:	9.3	↗
9:	8.9	↓
10:	7.2	→
Serie		87 (0x)
Total		536 (5x)

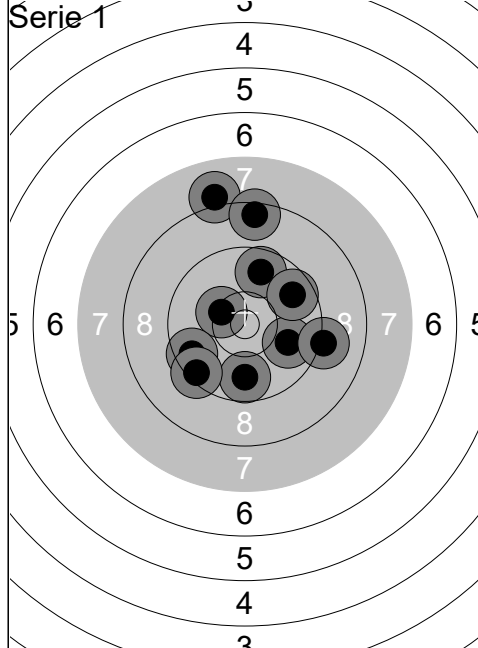

1:	9.9	➤
2:	10.4	↩
3:	9.1	➤
4:	9.8	↓
5:	9.6	↩
6:	9.4	↩
7:	8.0	↑
8:	9.7	↑
9:	9.7	➤
10:	8.5	↑
Serie		89 (0x)
Total		89 (0x)

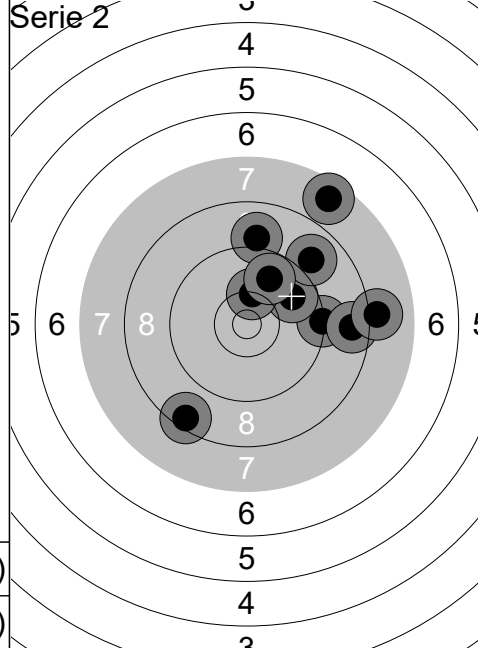

1:	9.3	➤
2:	9.8	➤
3:	8.5	↙
4:	7.6	↗
5:	8.9	↗
6:	9.0	↑
7:	10.3	↑
8:	8.6	➔
9:	9.8	↗
10:	8.1	➔
Serie		85 (0x)
Total		174 (0x)

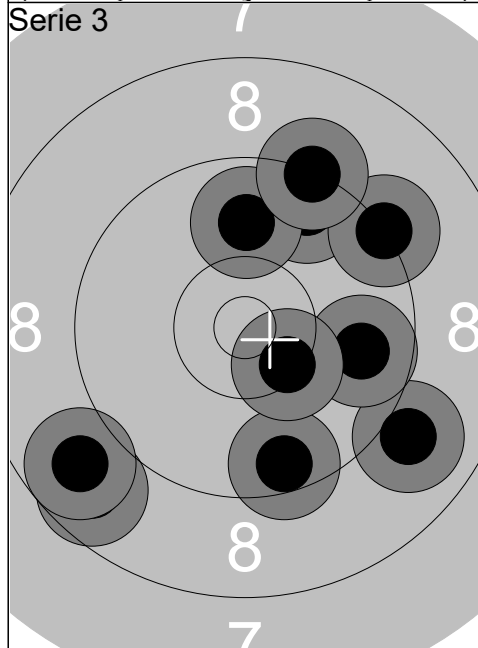

1:	9.5	↓
2:	9.0	➤
3:	8.7	↙
4:	9.6	↗
5:	9.9	↑
6:	9.2	➤
7:	9.7	➤
8:	9.3	↑
9:	10.4x	↘
10:	8.8	↙
Serie		89 (1x)
Total		263 (1x)

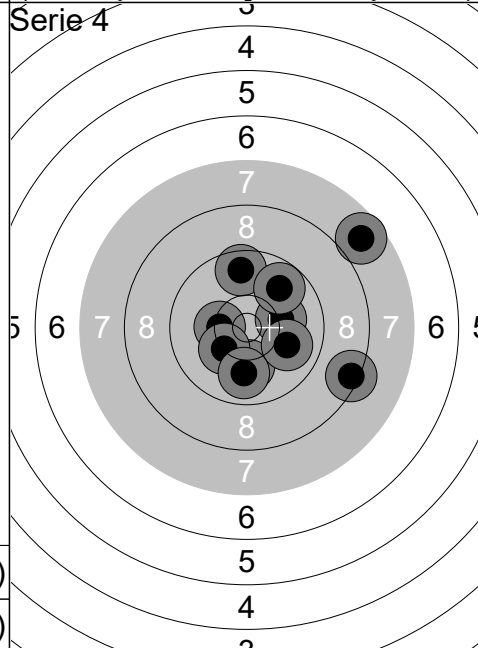

1:	8.4	➤
2:	9.7	↑
3:	10.3	↩
4:	10.1	↓
5:	7.7	↗
6:	10.2	↙
7:	10.2	➔
8:	9.9	↓
9:	10.0	➤
10:	9.8	↗
Serie		92 (0x)
Total		355 (1x)

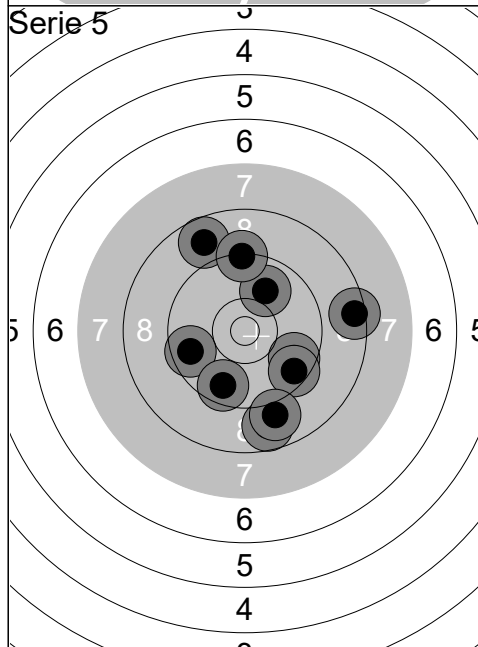

1:	8.8	↓
2:	8.5	➤
3:	9.9	↗
4:	8.8	↗
5:	9.3	↑
6:	9.7	↘
7:	9.5	↘
8:	9.6	↩
9:	9.0	↓
10:	9.6	↘
Serie		87 (0x)
Total		442 (1x)

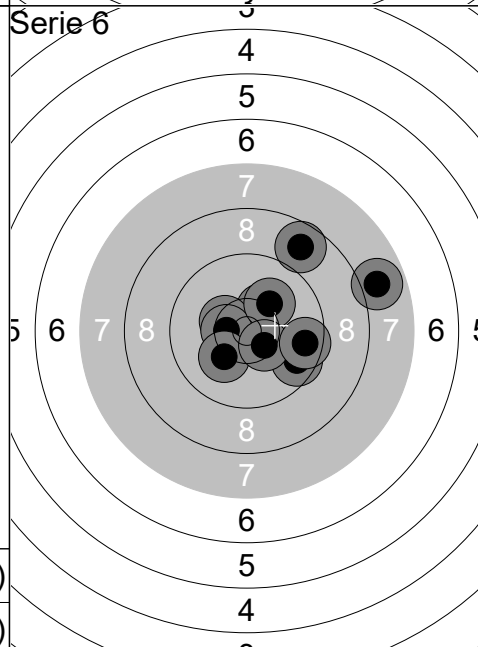

1:	7.9	➤
2:	10.4	↗
3:	10.4x	↙
4:	9.6	↘
5:	10.5x	↙
6:	8.7	↗
7:	10.2	↗
8:	10.2	↙
9:	10.4x	↘
10:	9.6	➔
Serie		93 (3x)
Total		535 (4x)

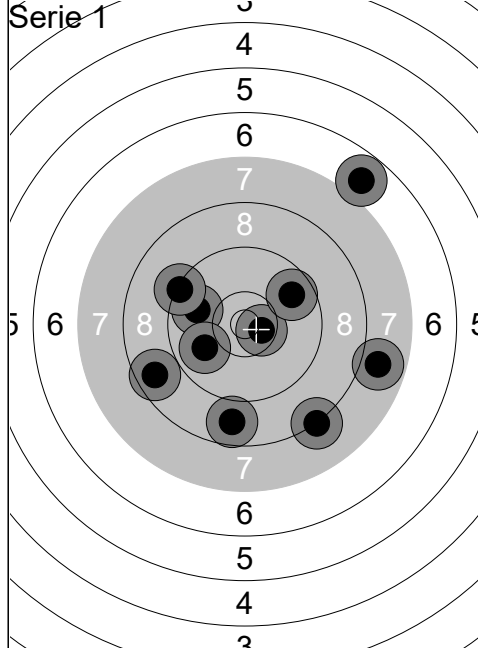

1:	9.8	↔
2:	6.8	↗
3:	10.5x	→
4:	9.7	↗
5:	8.6	↖
6:	8.7	↓
7:	8.2	↓
8:	7.9	→
9:	9.3	↖
10:	9.9	↖
Serie		83 (1x)
Total		83 (1x)

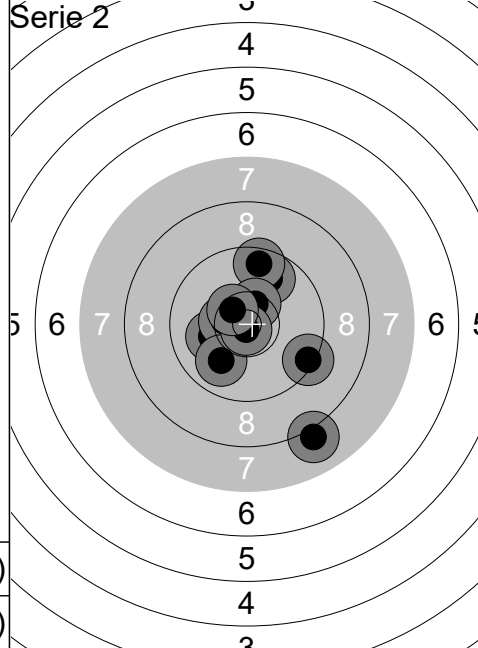

1:	9.8	↗
2:	9.6	↑
3:	10.1	↖
4:	10.4x	↖
5:	8.0	↓
6:	10.4x	↗
7:	10.0	↓
8:	10.8x	↓
9:	9.4	→
10:	10.5x	↖
Serie		95 (4x)
Total		178 (5x)

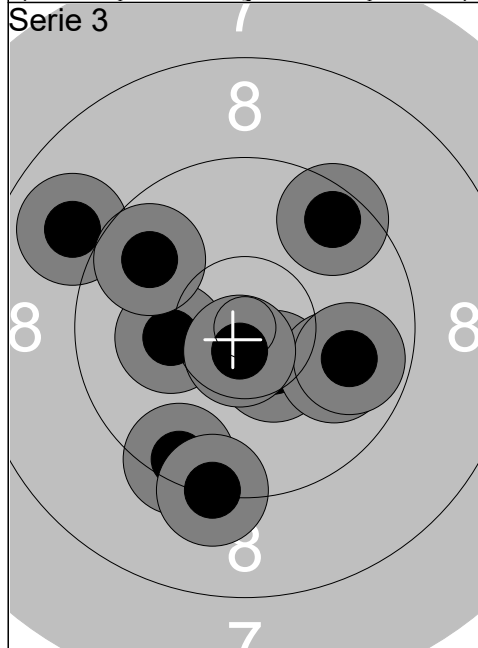

1:	9.5	↓
2:	10.5x	↘
3:	10.0	→
4:	9.5	↗
5:	9.8	→
6:	10.2	↖
7:	8.9	↖
8:	9.3	↓
9:	10.7x	↓
10:	9.8	↖
Serie		93 (2x)
Total		271 (7x)

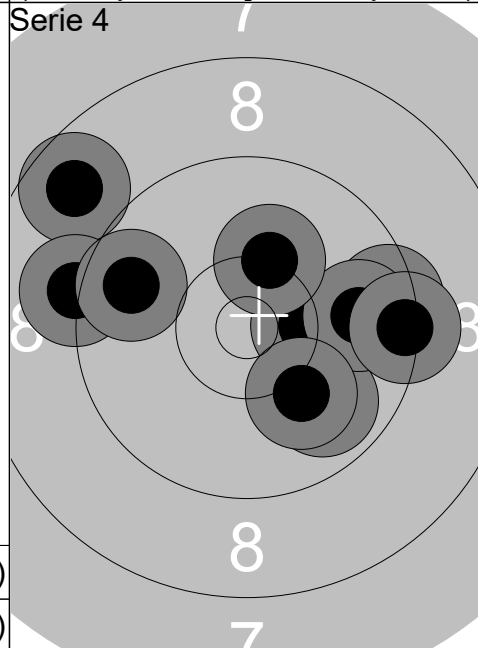

1:	9.5	→
2:	8.7	↖
3:	9.2	↖
4:	9.9	↓
5:	9.7	↖
6:	10.3	→
7:	9.8	→
8:	9.4	→
9:	10.1	↘
10:	10.2	↗
Serie		92 (0x)
Total		363 (7x)

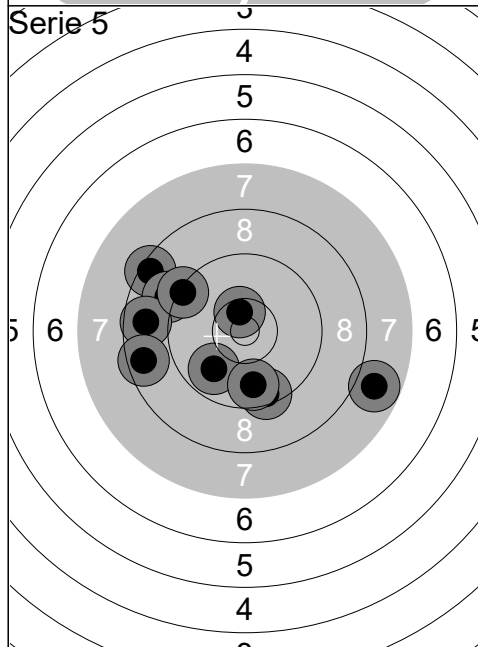

1:	9.5	↓
2:	10.5x	↗
3:	7.8	→
4:	8.4	↖
5:	9.8	↓
6:	9.7	↓
7:	9.1	↖
8:	8.7	↖
9:	8.6	↖
10:	9.3	↖
Serie		86 (1x)
Total		449 (8x)

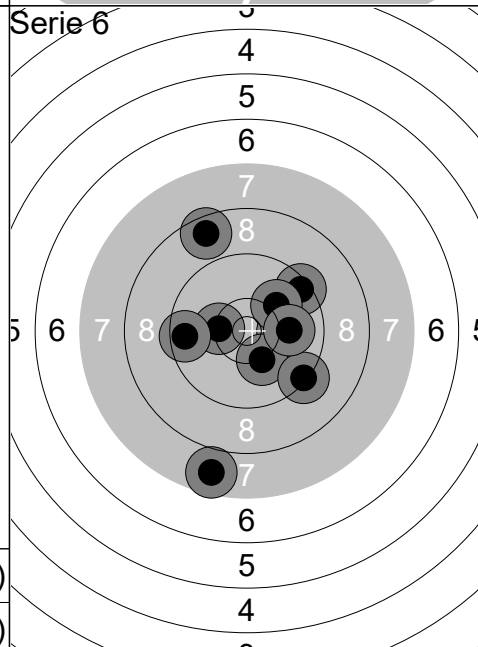

1:	9.4	↗
2:	10.2	→
3:	10.2	↘
4:	10.3	↖
5:	8.6	↗
6:	7.7	↓
7:	9.6	↖
8:	10.1	↗
9:	9.3	↘
10:	10.0	→
Serie		92 (0x)
Total		541 (8x)

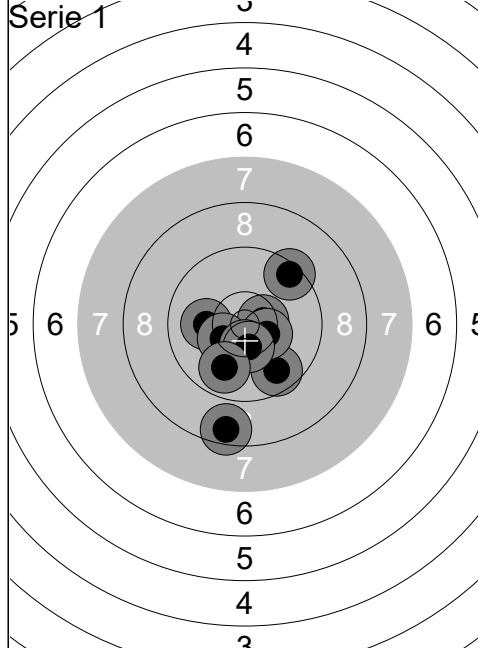

1:	10.5x →
2:	8.6 ↓
3:	10.1 ←
4:	9.7 ↓
5:	10.4x →
6:	10.4x ↙
7:	10.5x ↓
8:	10.4x ↓
9:	9.4 ↗
10:	9.9 ↓
Serie	95 (5x)
Total	95 (5x)

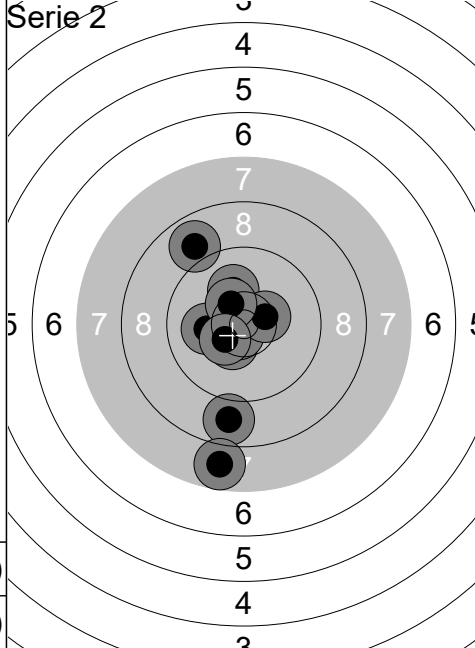

1:	8.8 ↓
2:	10.4x ↙
3:	10.7x ↙
4:	10.1 ↗
5:	10.1 ←
6:	10.4x →
7:	10.4x ↗
8:	7.8 ↓
9:	10.4x ↙
10:	8.9 ↗
Serie	93 (5x)
Total	188 (10x)

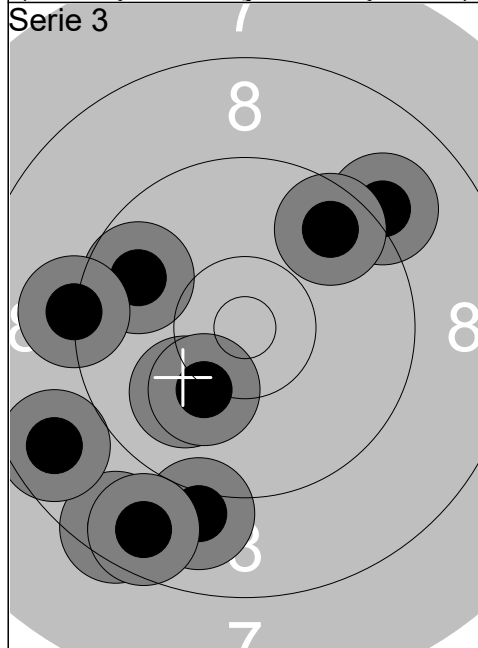

1:	9.8 ←
2:	10.1 ↙
3:	10.2 ↙
4:	9.1 ↗
5:	9.0 ↓
6:	9.2 ←
7:	8.6 ↓
8:	8.7 ↓
9:	9.6 ↗
10:	8.7 ↙
Serie	89 (0x)
Total	277 (10x)

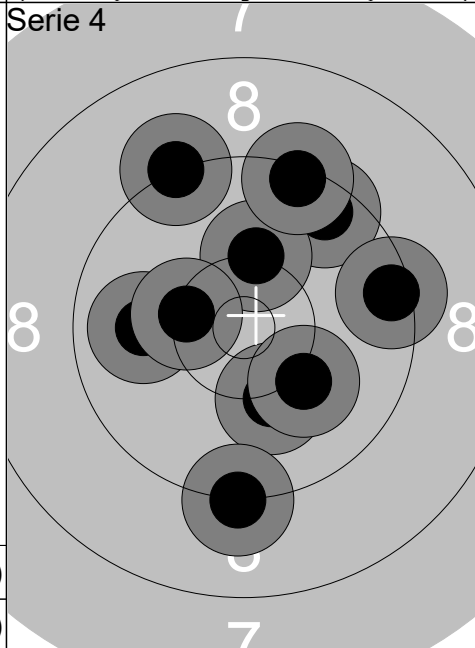

1:	9.5 ↗
2:	10.2 ↑
3:	9.3 ↑
4:	10.2 ↓
5:	10.1 ↙
6:	9.2 ↗
7:	9.4 →
8:	9.9 ←
9:	10.4 ←
10:	9.2 ↓
Serie	94 (0x)
Total	371 (10x)

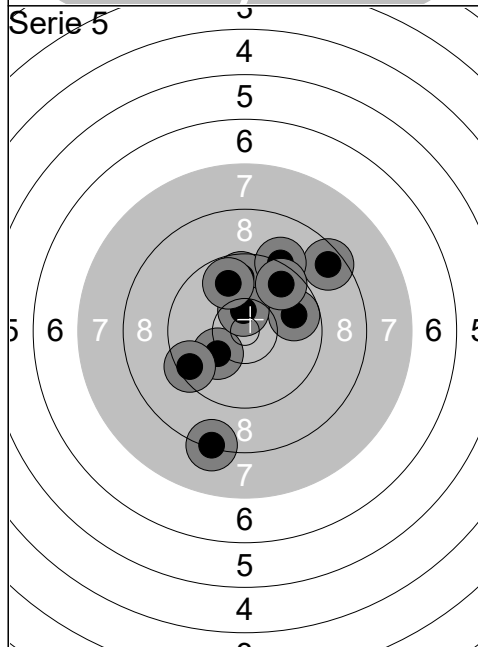

1:	10.2 ↙
2:	9.8 →
3:	8.6 ↗
4:	9.7 ↑
5:	9.2 ↗
6:	10.5x ↑
7:	9.6 ↗
8:	9.8 ↗
9:	8.3 ↓
10:	9.5 ↙
Serie	90 (1x)
Total	461 (11x)

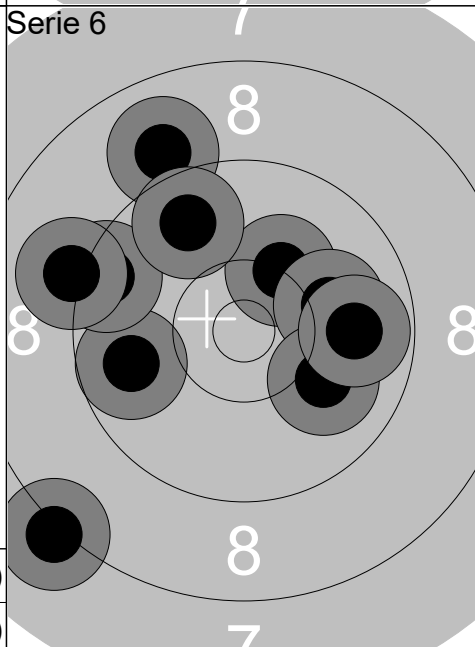

1:	10.2 ↗
2:	9.0 ↗
3:	9.8 ←
4:	10.0 →
5:	10.0 ↙
6:	9.5 ←
7:	9.8 →
8:	8.1 ↙
9:	9.7 ↗
10:	9.1 ←
Serie	92 (0x)
Total	553 (11x)

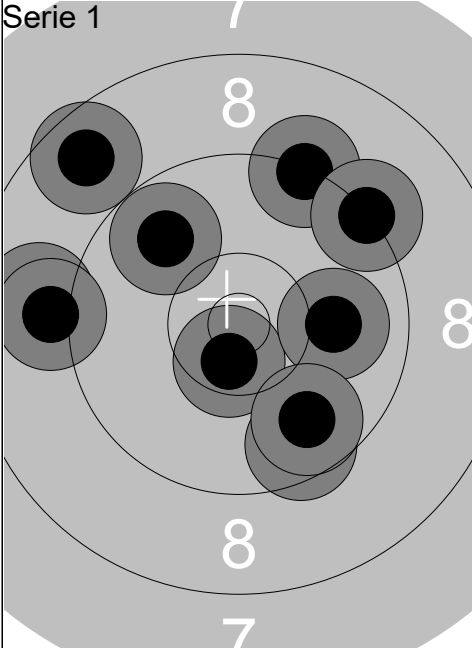
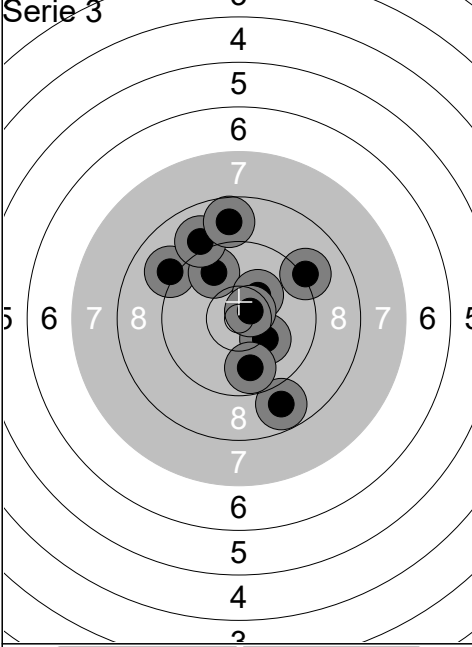
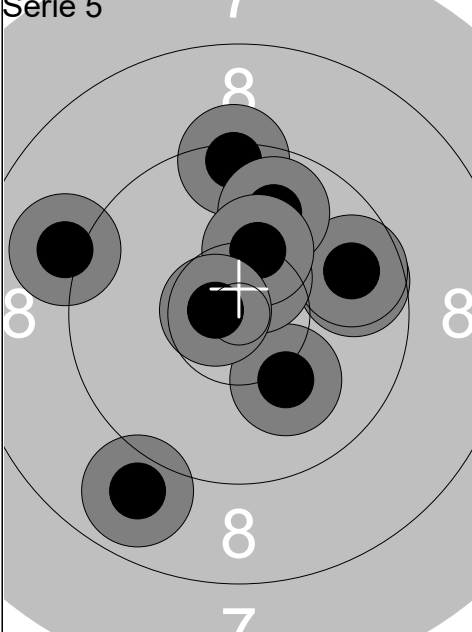
Skjutlag 1	Tavla 40	Åsa Edvinsson	
1 Luft		Umeå Pistolskytteklubb	D 3
11.11.2023		Hösträffen 2023	Umeå skytteallians
Serie 1		1: 8.9 ← 2: 9.8 ↗ 3: 9.3 ↗ 4: 9.2 ↗ 5: 10.6x ↓ 6: 9.6 ↓ 7: 9.0 ← 8: 10.0 → 9: 8.7 ↗ 10: 9.8 ↓ Serie 90 (1x) Total 90 (1x)	Serie 2
Serie 3		1: 9.1 ← 2: 9.8 ↗ 3: 10.2 ↓ 4: 9.0 ↗ 5: 8.8 ↓ 6: 8.8 ↑ 7: 10.3 ↗ 8: 10.6x ↗ 9: 9.2 ↗ 10: 9.8 ↓ Serie 91 (1x) Total 274 (4x)	Serie 4
Serie 5		1: 9.7 → 2: 9.7 → 3: 9.1 ← 4: 10.1 ↓ 5: 10.5x ↗ 6: 9.4 ↑ 7: 8.9 ↓ 8: 9.9 ↗ 9: 10.3 ↗ 10: 10.7x ← Serie 93 (2x) Total 459 (6x)	Serie 6
			1: 10.2 ↘ 2: 10.2 ← 3: 9.6 ↓ 4: 7.6 ↗ 5: 9.5 ↑ 6: 10.3 ↙ 7: 10.6x → 8: 10.6x → 9: 9.8 ← 10: 9.6 ↗ Serie 93 (2x) Total 183 (3x)
			1: 10.0 → 2: 10.0 ↓ 3: 9.1 ← 4: 10.1 ↗ 5: 8.0 ↗ 6: 10.0 ↗ 7: 9.9 ↙ 8: 8.2 ← 9: 9.6 → 10: 9.8 ↗ Serie 92 (0x) Total 366 (4x)
			1: 10.0 → 2: 9.6 ← 3: 9.7 ↓ 4: 9.2 ← 5: 8.9 ← 6: 10.6x ← 7: 10.1 ← 8: 9.9 ← 9: 8.6 ↓ 10: 10.2 ↙ Serie 92 (1x) Total 551 (7x)

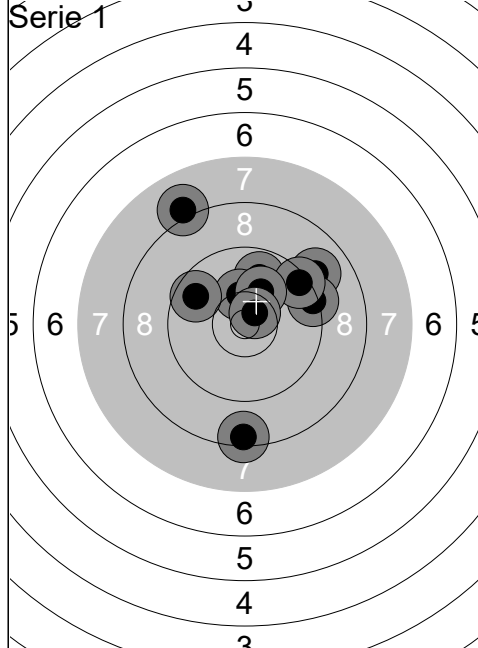

1:	8.1	↖
2:	9.9	↗
3:	9.0	↗
4:	8.4	↓
5:	9.3	→
6:	10.3	↑
7:	9.4	↗
8:	9.7	↖
9:	10.1	↗
10:	10.6x	↗
Serie	91 (1x)	
Total	91 (1x)	

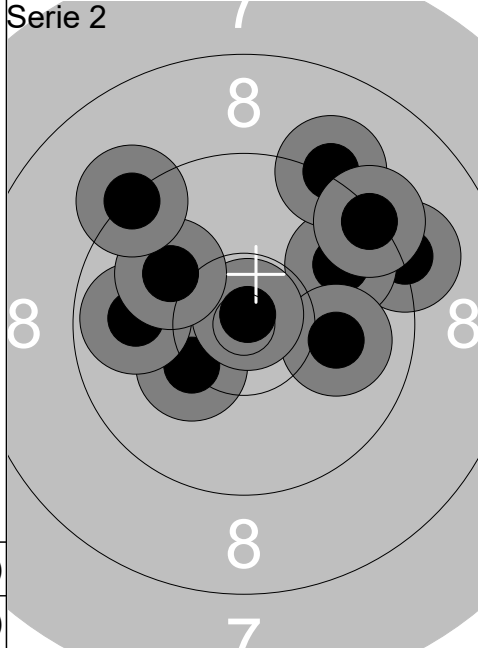

1:	10.3	↙
2:	9.2	→
3:	9.8	↗
4:	10.0	→
5:	9.2	↗
6:	9.9	←
7:	10.8x	↗
8:	10.0	↖
9:	9.3	↗
10:	9.3	↖
Serie	94 (1x)	
Total	185 (2x)	

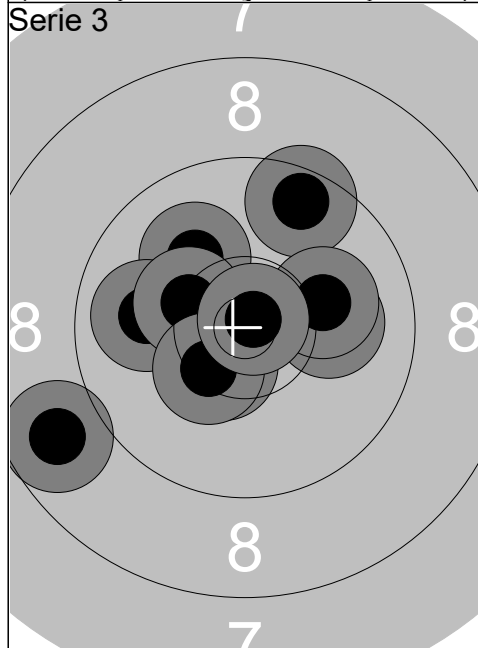

1:	10.1	↖
2:	8.8	↙
3:	10.5x	↙
4:	9.9	←
5:	9.6	↗
6:	10.1	→
7:	10.1	→
8:	10.3	↖
9:	10.4x	↙
10:	10.8x	↗
Serie	96 (3x)	
Total	281 (5x)	

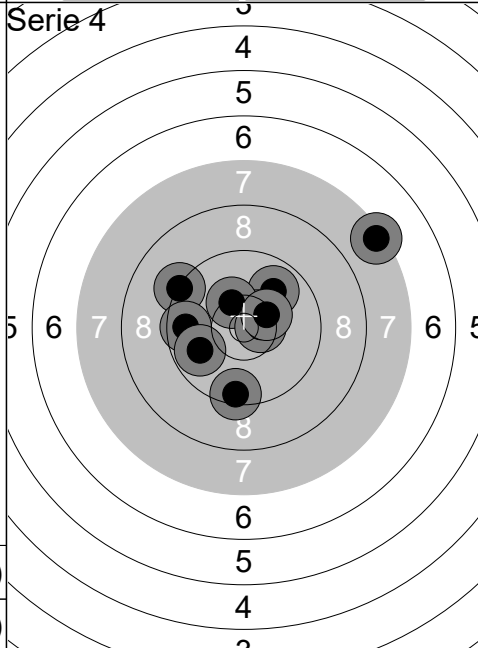

1:	9.9	↗
2:	7.4	↗
3:	9.3	↖
4:	10.5x	↗
5:	9.7	←
6:	9.8	↖
7:	10.3	↖
8:	10.6x	→
9:	10.4x	↗
10:	9.4	↓
Serie	92 (3x)	
Total	373 (8x)	

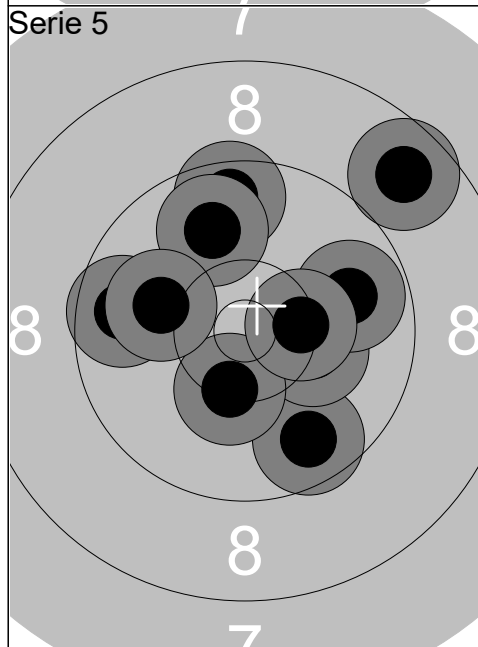

1:	9.7	↘
2:	8.7	↗
3:	9.6	↑
4:	9.7	←
5:	10.2	→
6:	10.3	↓
7:	9.9	↑
8:	9.8	→
9:	10.1	←
10:	10.4x	→
Serie	93 (1x)	
Total	466 (9x)	

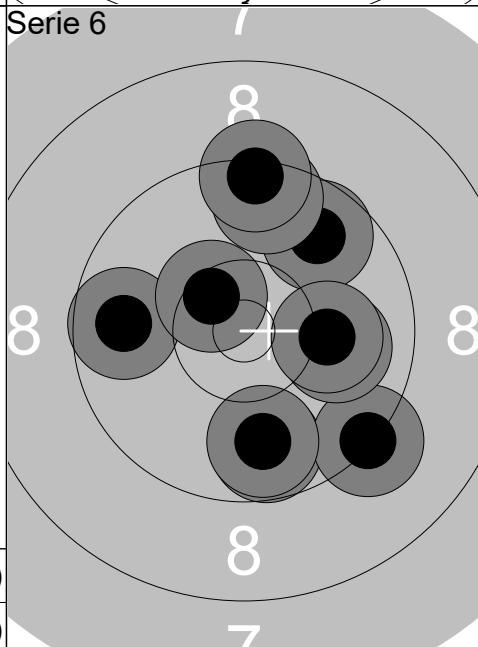

1:	9.8	↓
2:	9.3	↘
3:	9.7	←
4:	10.5x	↖
5:	10.0	→
6:	9.7	↗
7:	9.6	↑
8:	9.8	↓
9:	10.1	→
10:	9.4	↑
Serie	93 (1x)	
Total	559 (10x)	

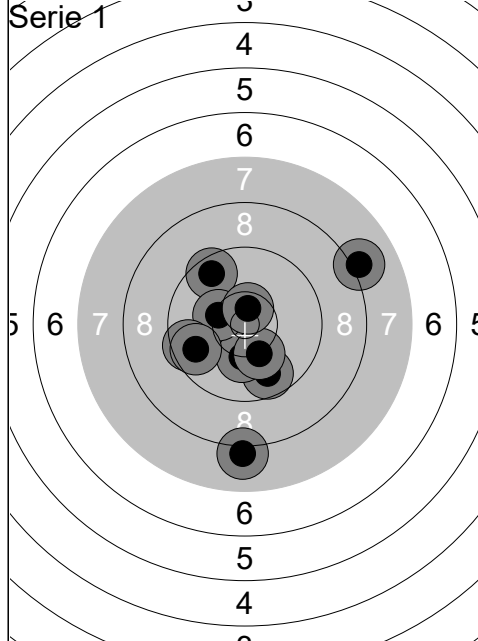

1:	9.7	↘
2:	10.2	↓
3:	10.2	↘
4:	9.6	↗
5:	10.3	←
6:	8.1	↓
7:	9.6	←
8:	8.1	↗
9:	9.7	↙
10:	10.6x	↑
Serie		92 (1x)
Total		92 (1x)

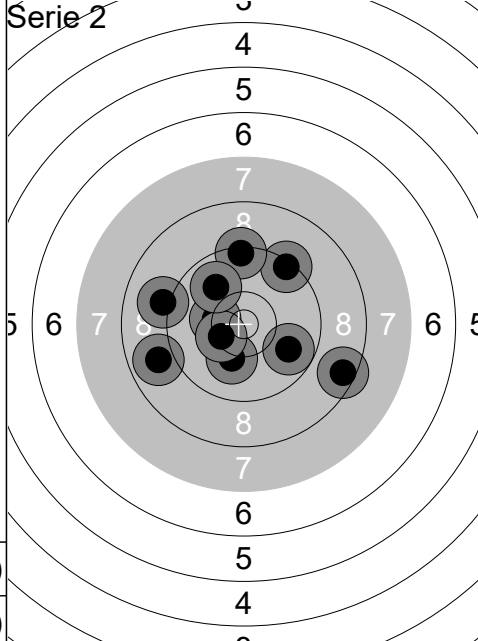

1:	9.8	↘
2:	8.5	↘
3:	9.4	↗
4:	10.3	←
5:	10.1	↓
6:	10.4x	↙
7:	9.4	↑
8:	9.1	←
9:	8.9	↙
10:	9.9	↖
Serie		91 (1x)
Total		183 (2x)

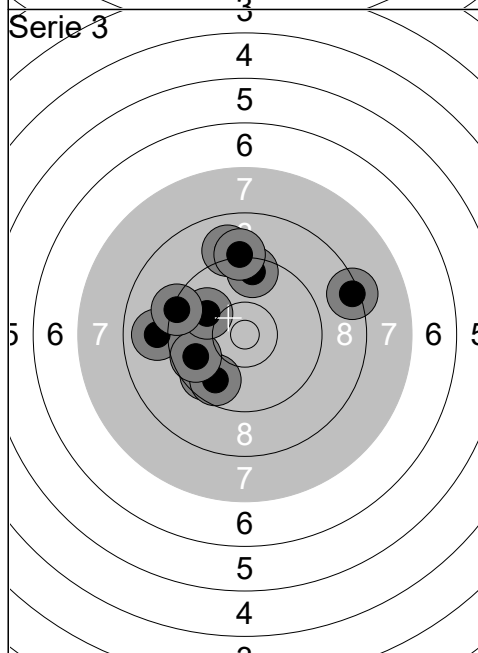

1:	9.7	↙
2:	9.0	←
3:	9.0	↑
4:	9.5	↑
5:	9.2	↑
6:	9.7	↘
7:	9.7	←
8:	10.0	↙
9:	9.3	←
10:	8.4	↗
Serie		90 (0x)
Total		273 (2x)

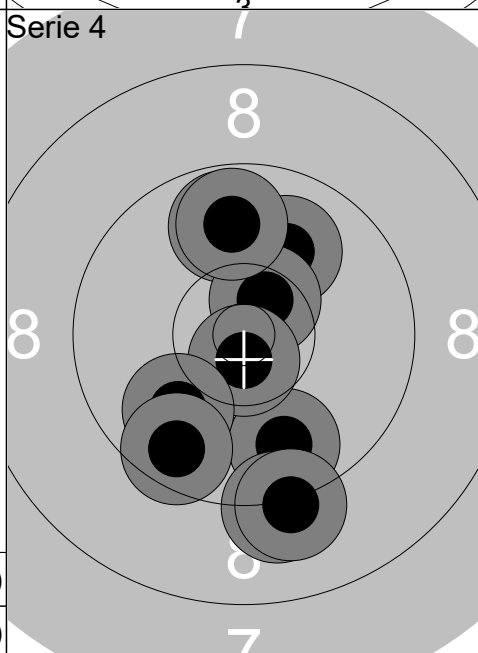

1:	9.8	↓
2:	9.8	↑
3:	10.0	↗
4:	10.5x	↗
5:	9.8	↑
6:	10.7x	↓
7:	9.2	↓
8:	9.9	↘
9:	9.6	↘
10:	9.2	↓
Serie		93 (2x)
Total		366 (4x)

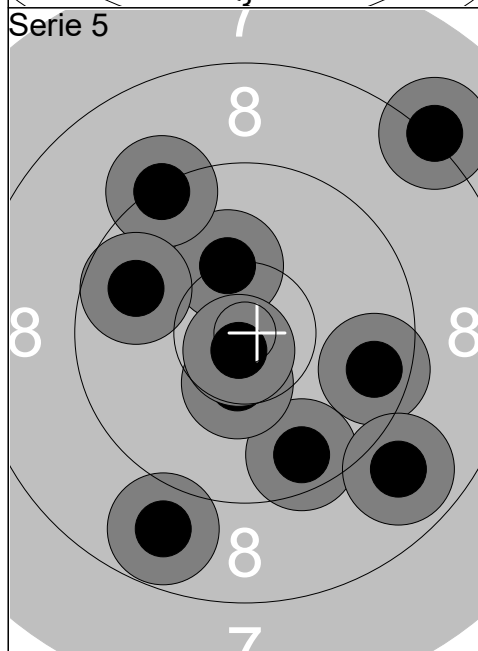

1:	9.6	↘
2:	9.6	↘
3:	8.9	↘
4:	8.2	↗
5:	10.2	↑
6:	9.3	↗
7:	10.4x	↘
8:	8.8	↘
9:	10.8x	↘
10:	9.8	←
Serie		90 (2x)
Total		456 (6x)

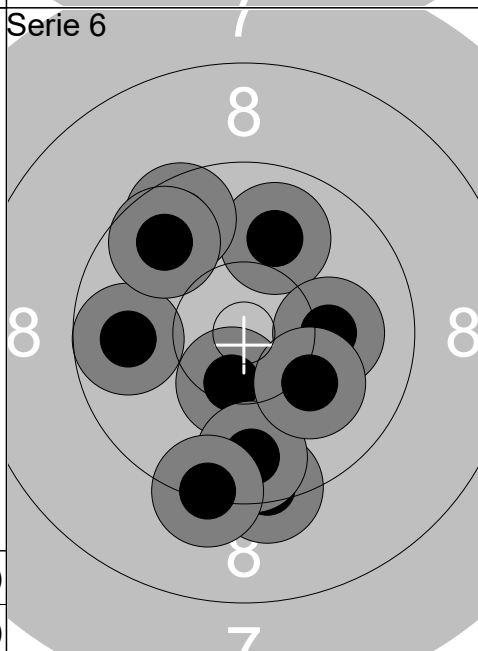

1:	9.4	↓
2:	9.8	←
3:	9.9	↗
4:	10.4x	↘
5:	9.7	↓
6:	9.6	↗
7:	10.1	→
8:	10.1	↘
9:	9.7	↗
10:	9.3	↓
Serie		93 (1x)
Total		549 (7x)

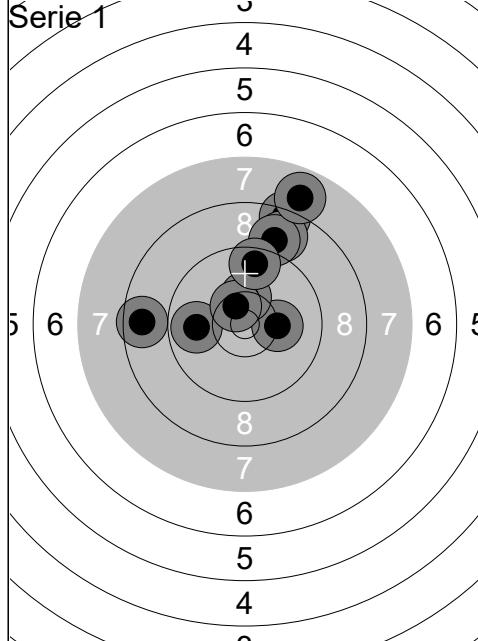

1:	8.6	←
2:	8.4	↑
3:	9.9	←
4:	10.2	→
5:	8.8	↑
6:	9.0	↑
7:	7.9	↑
8:	10.3	↑
9:	10.5x	↖
10:	9.6	↑
Serie	88	(1x)
Total	88	(1x)

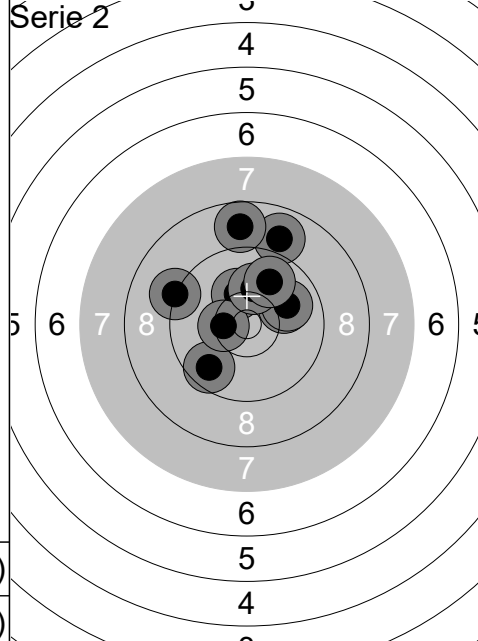

1:	9.7	↙
2:	10.2	↑
3:	10.0	↗
4:	9.2	↖
5:	9.9	↗
6:	8.9	↑
7:	10.4x	←
8:	8.8	↑
9:	10.1	↑
10:	9.9	↑
Serie	92	(1x)
Total	180	(2x)

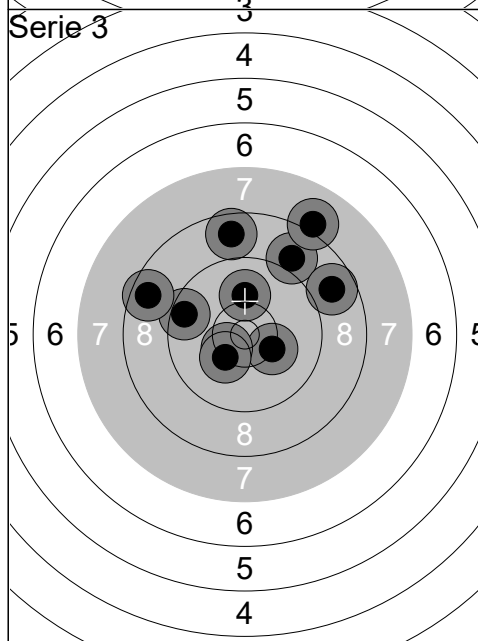

1:	10.1	↑
2:	9.5	↖
3:	8.7	↑
4:	10.3	↗
5:	8.6	↖
6:	9.0	↑
7:	8.8	↗
8:	10.4x	↙
9:	8.1	↑
10:	10.3	↙
Serie	90	(1x)
Total	270	(3x)

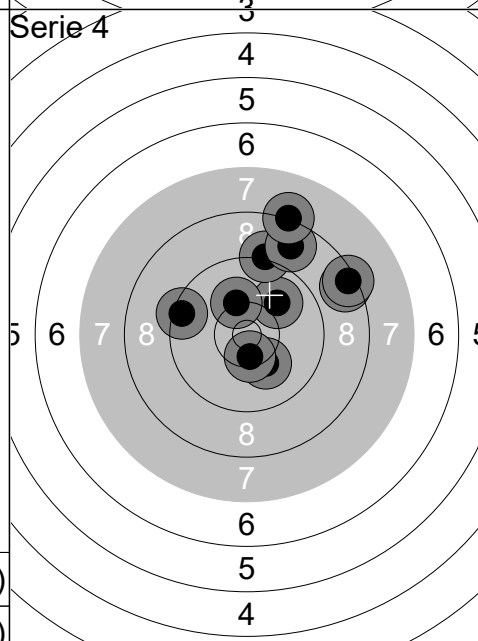

1:	10.0	↗
2:	8.5	↗
3:	8.4	↗
4:	10.2	↘
5:	9.2	↑
6:	9.4	←
7:	8.7	↑
8:	8.2	↑
9:	10.2	↑
10:	10.4x	↘
Serie	90	(1x)
Total	360	(4x)

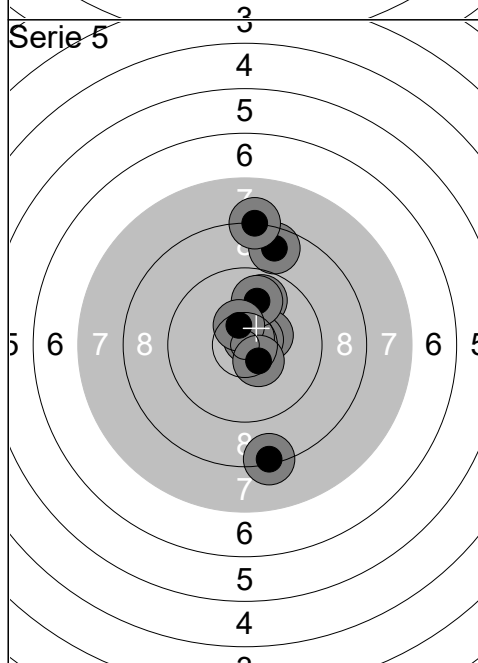

1:	8.7	↑
2:	9.9	↑
3:	10.4x	↗
4:	8.2	↑
5:	10.6x	↗
6:	10.8x	↗
7:	9.9	↑
8:	8.3	↘
9:	10.5x	↑
10:	10.5x	↘
Serie	92	(5x)
Total	452	(9x)

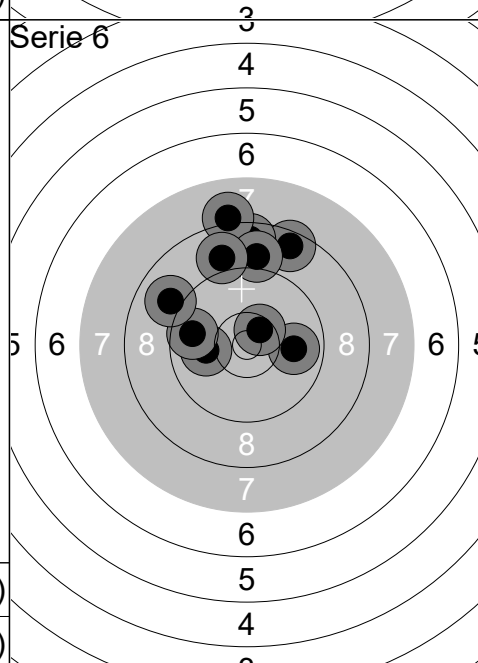

1:	8.5	↑
2:	9.9	→
3:	10.5x	↗
4:	8.6	↑
5:	8.1	↑
6:	9.0	↑
7:	10.0	←
8:	9.7	←
9:	8.9	↑
10:	9.0	↖
Serie	88	(1x)
Total	540	(10x)

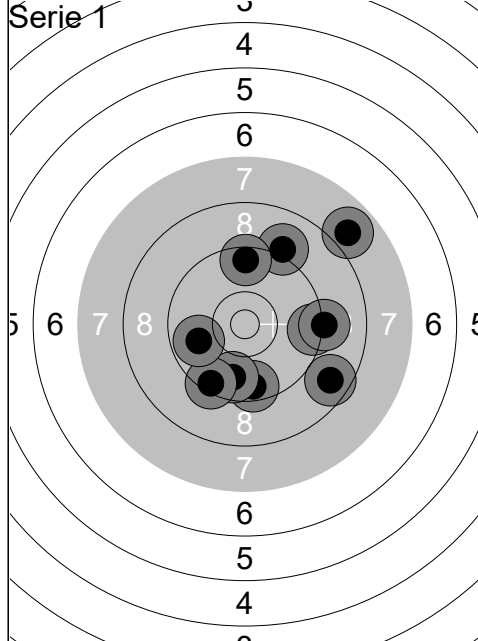

1:	9.6	↓
2:	9.1	↗
3:	7.9	↗
4:	9.4	→
5:	9.7	↓
6:	9.4	↓
7:	9.5	↑
8:	8.7	↘
9:	9.9	←
10:	9.2	→
Serie	87 (0x)	
Total	87 (0x)	

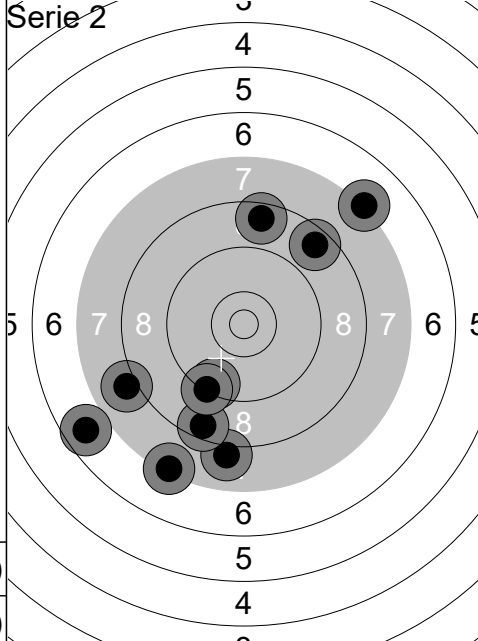

1:	8.0	↓
2:	6.7	↙
3:	9.5	↓
4:	8.5	↓
5:	9.3	↓
6:	7.2	↗
7:	8.6	↗
8:	7.3	↓
9:	8.0	↙
10:	8.6	↑
Serie	78 (0x)	
Total	165 (0x)	

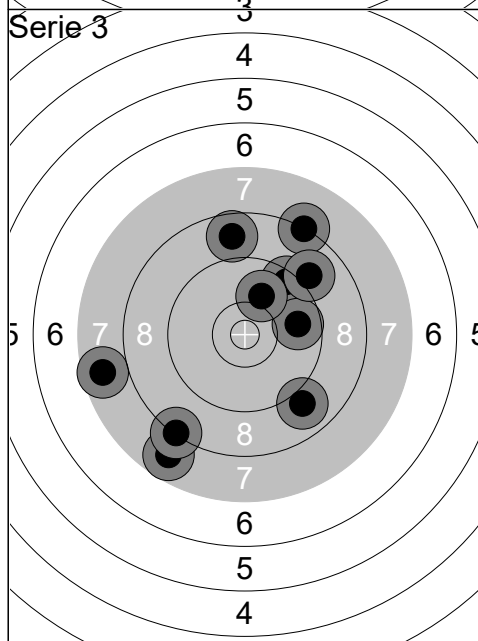

1:	8.7	↑
2:	9.4	↗
3:	7.7	←
4:	8.2	↗
5:	9.7	→
6:	8.9	↘
7:	10.0	↗
8:	7.8	↓
9:	9.0	↗
10:	8.3	↘
Serie	83 (0x)	
Total	248 (0x)	

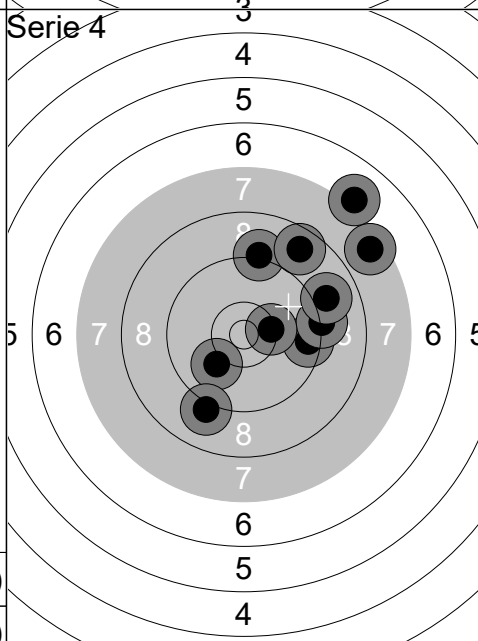

1:	9.5	→
2:	9.1	↑
3:	10.0	↙
4:	7.6	↗
5:	9.1	↓
6:	9.2	→
7:	7.1	↗
8:	8.7	↗
9:	10.3	→
10:	8.9	↗
Serie	86 (0x)	
Total	334 (0x)	

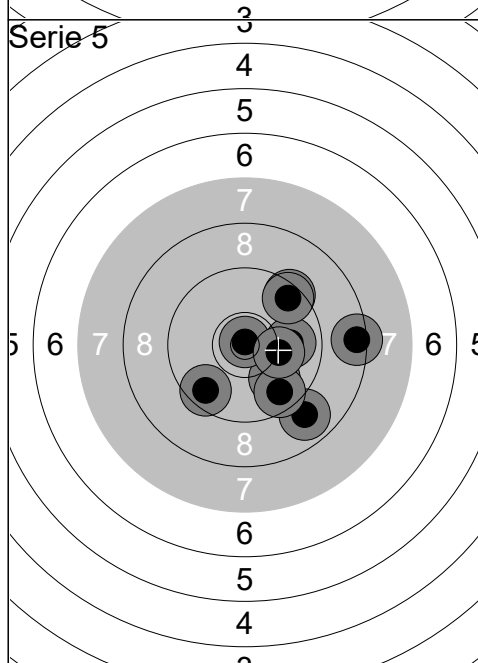

1:	9.9	→
2:	9.5	↗
3:	9.9	↘
4:	8.9	↘
5:	10.9x	↑
6:	9.5	↗
7:	9.6	↘
8:	8.4	→
9:	9.6	↘
10:	10.2	→
Serie	90 (1x)	
Total	424 (1x)	

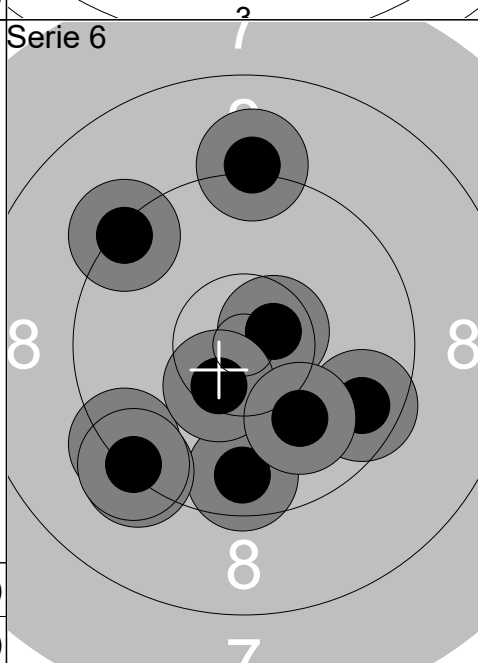

1:	10.6x	↗
2:	9.4	↙
3:	9.6	↓
4:	9.3	↙
5:	9.1	↑
6:	9.3	↖
7:	10.5x	↘
8:	9.6	↘
9:	10.0	↘
10:	9.3	↙
Serie	93 (2x)	
Total	517 (3x)	

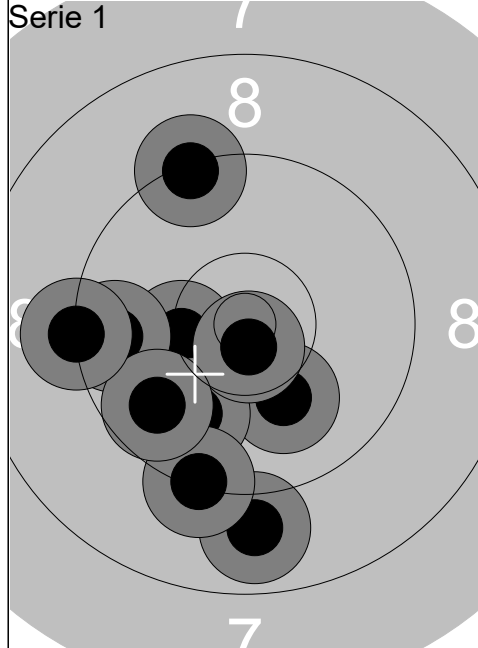

1:	10.1	↘
2:	10.3	←
3:	9.9	↘
4:	10.7x	↘
5:	9.6	←
6:	8.9	↘
7:	9.3	↘
8:	9.3	↑
9:	9.7	↙
10:	9.2	←
Serie		92 (1x)
Total		92 (1x)

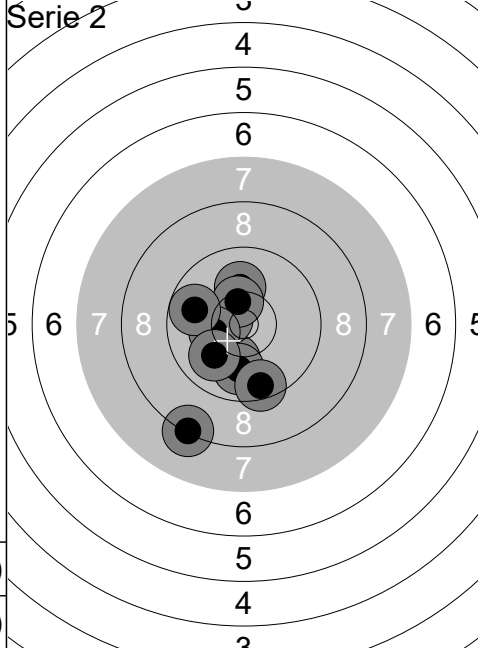

1:	10.1	↘
2:	10.1	↑
3:	10.6x	←
4:	9.9	↘
5:	10.4x	↑
6:	9.5	↘
7:	8.3	↘
8:	10.3	←
9:	9.8	←
10:	10.0	↙
Serie		95 (2x)
Total		187 (3x)

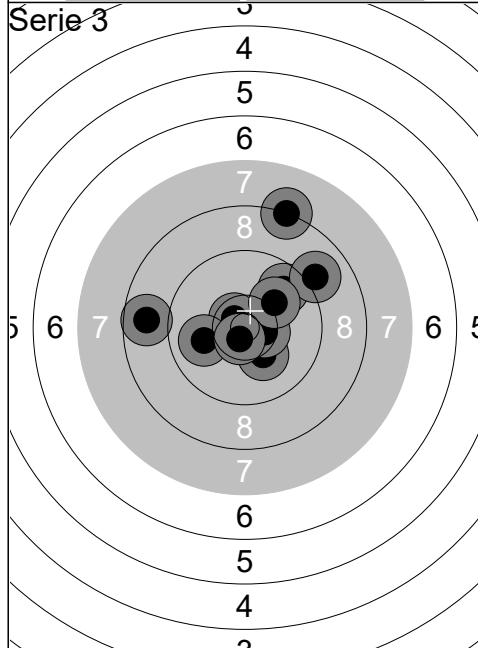

1:	10.2	↘
2:	9.7	↗
3:	10.6x	↖
4:	8.2	↑
5:	10.0	←
6:	10.5x	→
7:	8.7	←
8:	9.0	↗
9:	10.1	↗
10:	10.7x	↘
Serie		94 (3x)
Total		281 (6x)

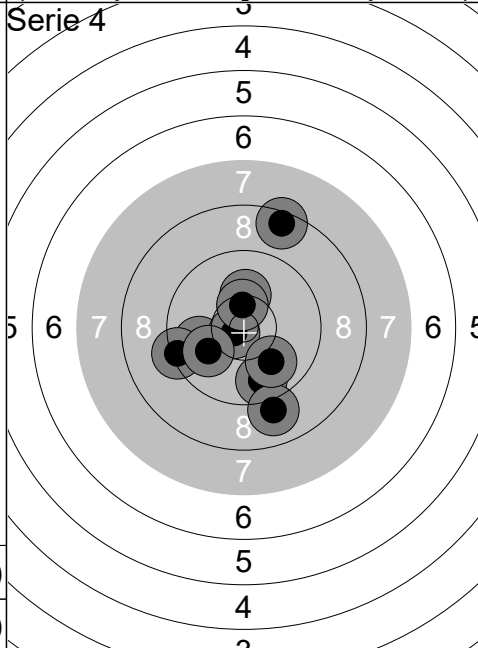

1:	9.9	←
2:	8.5	↑
3:	9.7	↘
4:	10.7x	↖
5:	10.2	↑
6:	9.4	←
7:	9.0	↘
8:	10.4x	↑
9:	10.0	←
10:	10.0	↘
Serie		94 (2x)
Total		375 (8x)

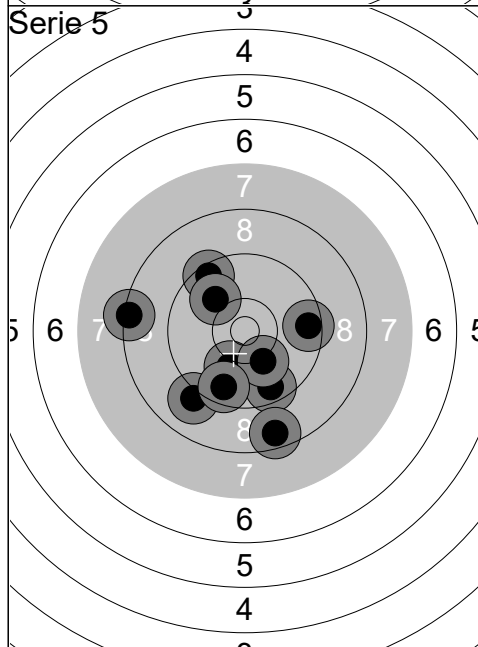

1:	9.6	↘
2:	8.6	↘
3:	9.5	→
4:	9.5	↑
5:	10.1	↘
6:	9.1	↘
7:	10.2	↘
8:	9.6	↘
9:	10.0	↗
10:	8.3	←
Serie		91 (0x)
Total		466 (8x)

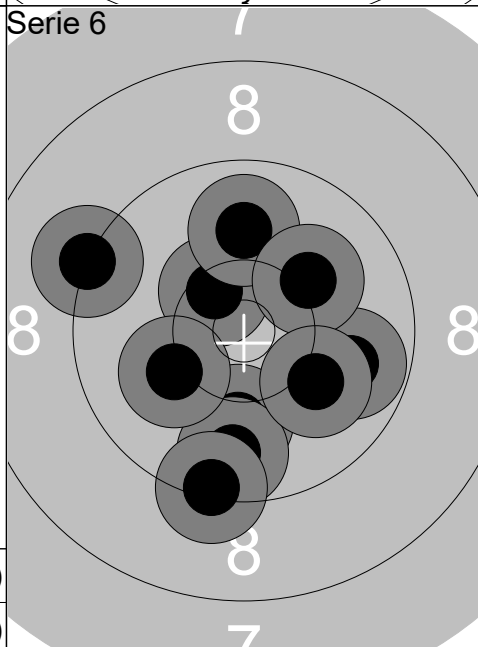

1:	10.0	↘
2:	10.4x	↖
3:	9.2	←
4:	9.7	↘
5:	9.8	→
6:	9.9	↑
7:	10.1	←
8:	9.3	↘
9:	10.1	↗
10:	10.1	↘
Serie		95 (1x)
Total		561 (9x)

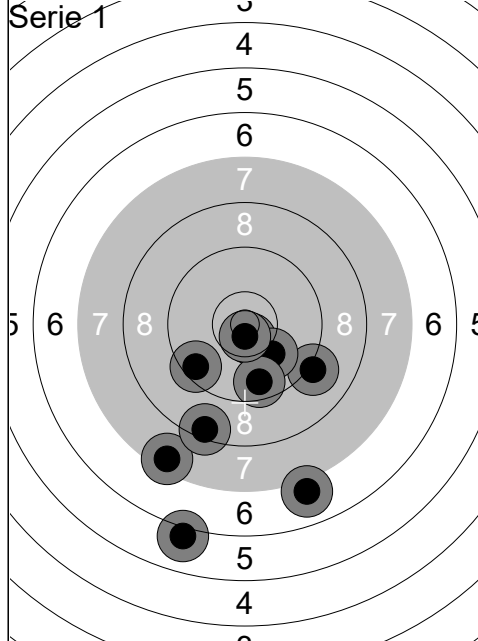

1:	9.1	↘
2:	7.5	↙
3:	10.6x	↘
4:	6.0	↘
5:	7.0	↘
6:	8.4	↘
7:	10.0	↘
8:	9.6	↘
9:	10.7x	↘
10:	9.5	↙
Serie	85 (2x)	
Total	85 (2x)	

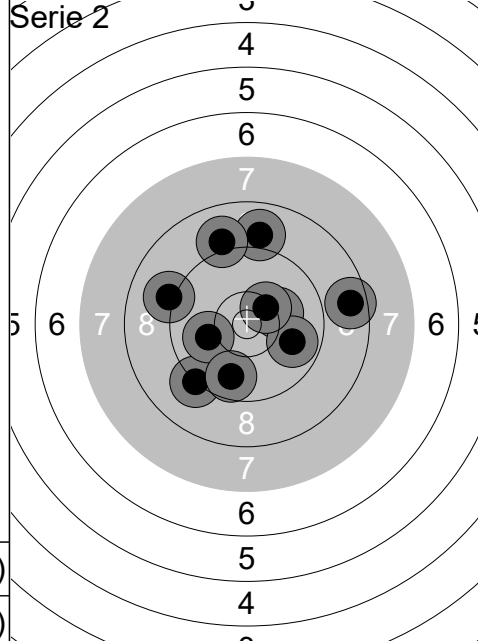

1:	8.9	↑
2:	9.1	↙
3:	9.2	↙
4:	9.0	↑
5:	10.2	➔
6:	10.0	↙
7:	9.7	↘
8:	9.9	➔
9:	10.4x	↗
10:	8.6	➔
Serie	91 (1x)	
Total	176 (3x)	

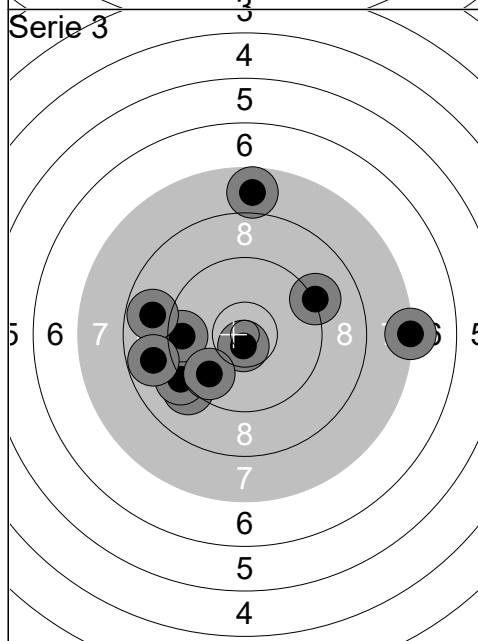

1:	9.2	↙
2:	7.8	↑
3:	9.2	↙
4:	9.5	↙
5:	10.7x	↘
6:	9.8	↙
7:	9.2	➔
8:	7.3	➔
9:	8.8	↙
10:	8.8	↙
Serie	85 (1x)	
Total	261 (4x)	

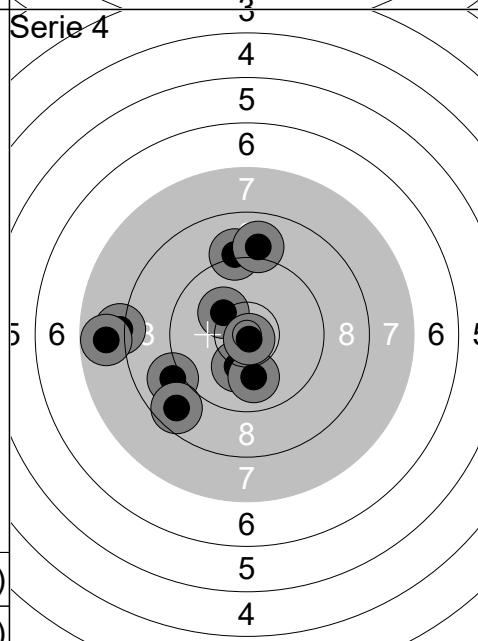

1:	10.2	↖
2:	9.0	↙
3:	10.2	↘
4:	9.1	↑
5:	8.1	↙
6:	9.0	↑
7:	10.0	↘
8:	10.8x	↘
9:	8.7	↘
10:	7.8	↙
Serie	90 (1x)	
Total	351 (5x)	

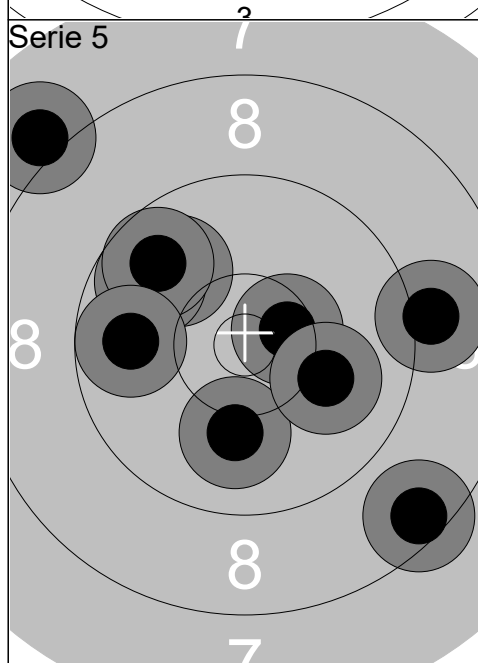

1:	9.9	↗
2:	9.8	↖
3:	8.5	↘
4:	10.5x	➔
5:	10.1	↘
6:	9.7	↗
7:	9.8	↙
8:	10.1	➔
9:	8.0	↗
10:	9.0	➔
Serie	91 (1x)	
Total	442 (6x)	

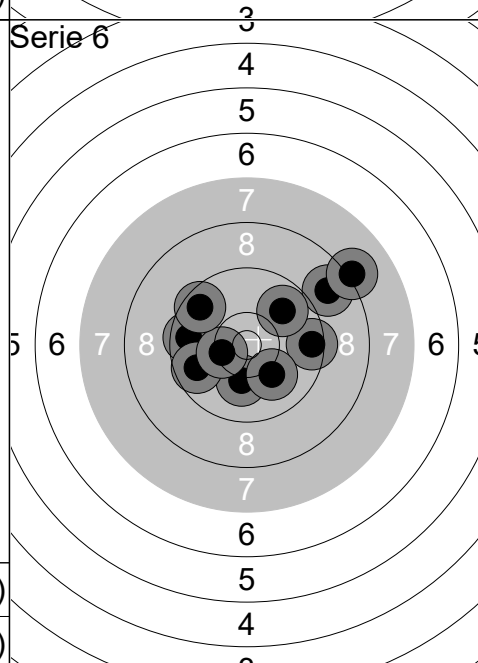

1:	10.1	↘
2:	8.8	↗
3:	9.6	↙
4:	9.7	↙
5:	8.1	↗
6:	9.5	➔
7:	9.8	↗
8:	10.4	↙
9:	9.6	↖
10:	10.1	↘
Serie	91 (0x)	
Total	533 (6x)	

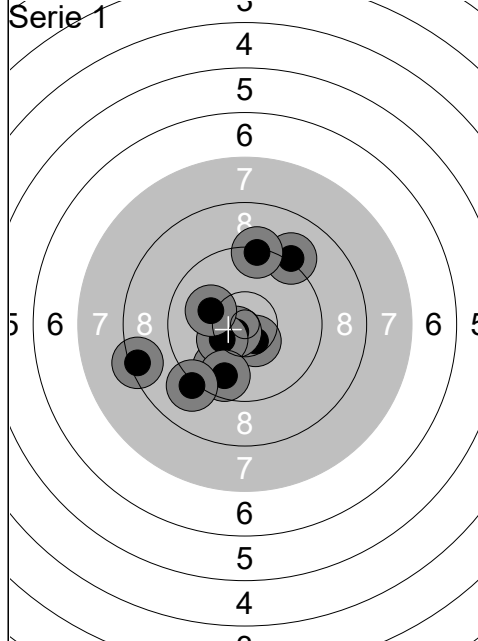

1:	10.5x ↘
2:	9.8 ↘
3:	10.7x ↙
4:	10.3 ↙
5:	10.1 ↙
6:	9.7 ↘
7:	8.4 ↙
8:	9.2 ↗
9:	9.1 ↘
10:	9.3 ↗
Serie	93 (2x)
Total	93 (2x)

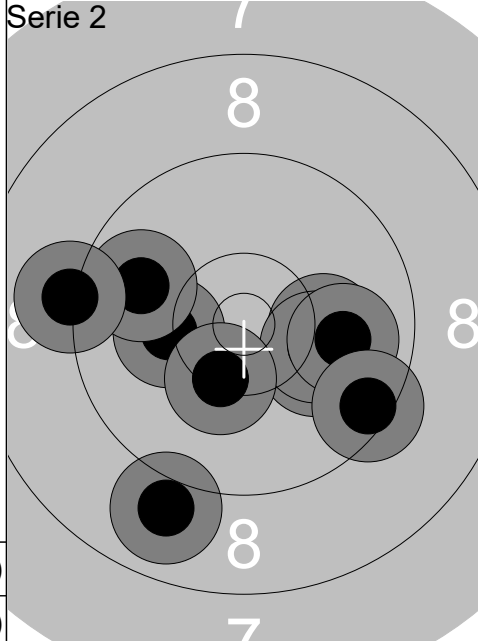

1:	10.1 →
2:	10.1 →
3:	8.9 ↘
4:	10.2 →
5:	9.9 →
6:	10.2 ↙
7:	9.8 ↙
8:	9.4 →
9:	10.3 ↘
10:	9.2 ↙
Serie	94 (0x)
Total	187 (2x)

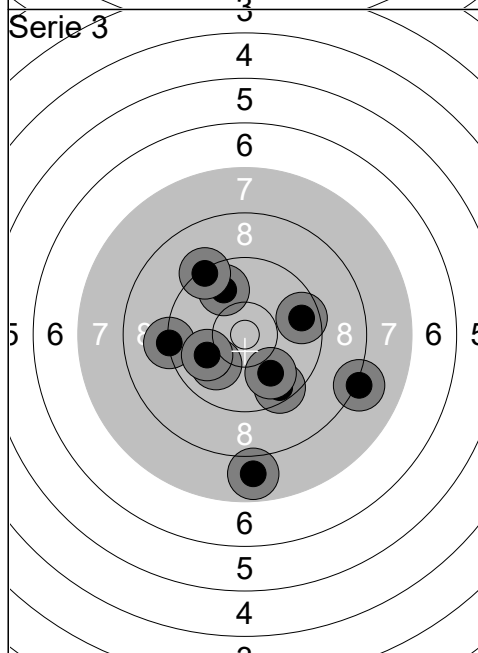

1:	9.5 ↘
2:	7.8 ↘
3:	9.3 ↙
4:	9.9 ↘
5:	10.0 ↘
6:	9.8 ↗
7:	10.0 ↙
8:	9.3 ↗
9:	8.2 →
10:	9.6 →
Serie	89 (0x)
Total	276 (2x)

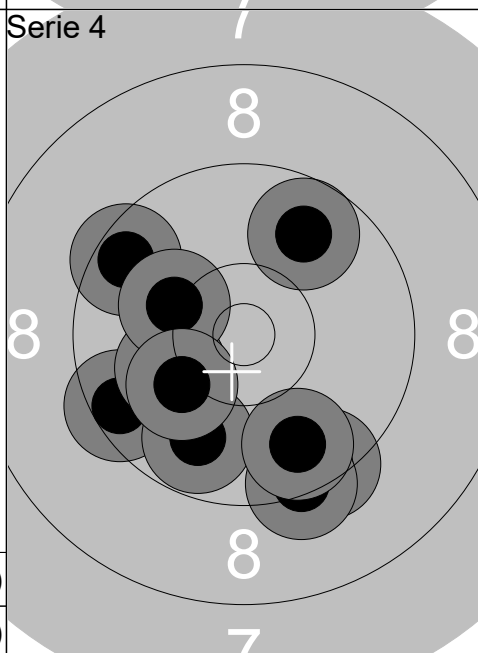

1:	9.5 ↙
2:	9.4 ↘
3:	9.8 ↗
4:	9.3 ↘
5:	10.1 ↙
6:	9.8 ↘
7:	9.5 ↗
8:	10.2 ↙
9:	10.1 ↙
10:	9.7 ↘
Serie	93 (0x)
Total	369 (2x)

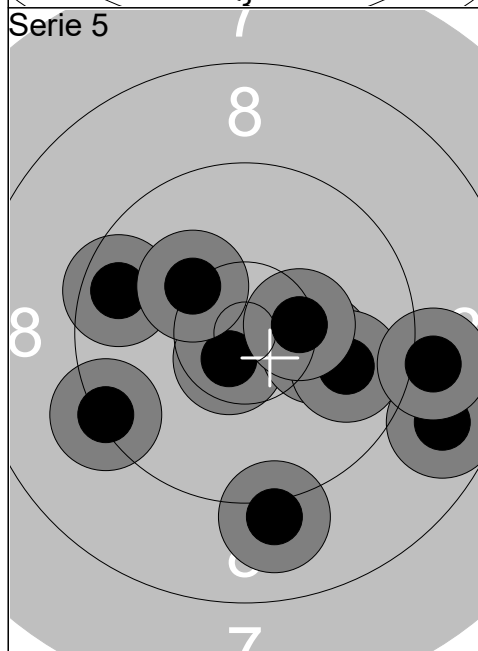

1:	8.8 →
2:	10.6x ↘
3:	9.1 ↘
4:	9.3 ↙
5:	10.2 →
6:	9.6 ↙
7:	10.2 ↗
8:	9.9 →
9:	10.4x →
10:	9.0 →
Serie	93 (2x)
Total	462 (4x)

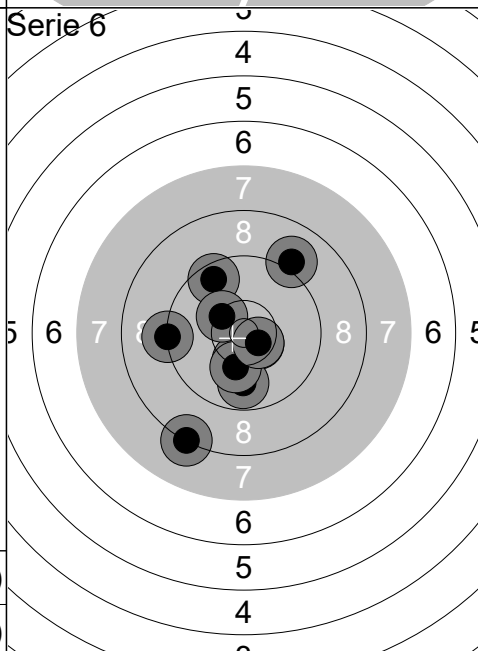

1:	8.2 ↘
2:	10.5x ↘
3:	9.6 ↗
4:	9.2 ↙
5:	10.3 ↘
6:	10.3 ↗
7:	9.8 ↘
8:	10.2 ↘
9:	10.5x ↘
10:	9.0 ↗
Serie	94 (2x)
Total	556 (6x)