

1:	10.5x ↗
2:	9.8 ←
3:	9.6 ↖
4:	10.1 ↑
5.56s	10.9x →
1:57m	10.5x ↓
2:20m	8.9 ↓
2:44m	9.9 ↓
3:11m	9.7 →
3:40m	9.3 ↗
Serie	93 (3x)
Total	93 (3x)

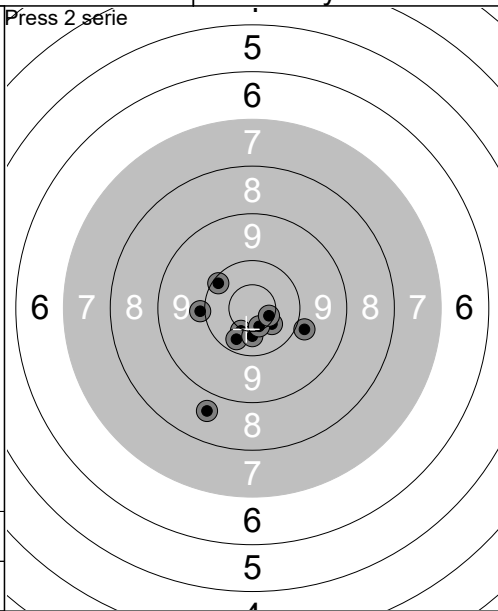

1:	10.5x ↓
2:	10.5x →
3:	10.3 ↓
4:	8.7 ↓
5:	10.4x ↓
2:14m	10.6x ↓
2:44m	9.9 →
3:15m	10.6x →
3:52m	9.9 ←
4:26m	10.1 ↖
Serie	96 (5x)
Total	189 (8x)

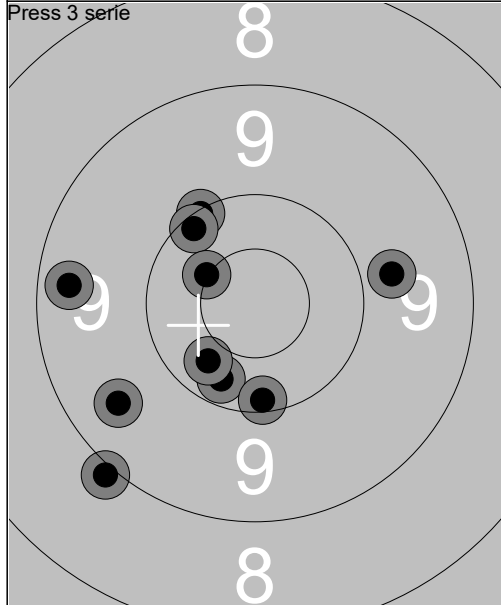

1:	10.3 ↓
2:	10.1 ↖
3:	9.8 →
4:	10.1 ↖
5:	9.4 ←
2:52m	10.1 ↓
3:26m	9.5 ←
4:04m	10.3 ↓
4:37m	9.0 ↓
5:13m	10.5x ↖
Serie	96 (1x)
Total	285 (9x)

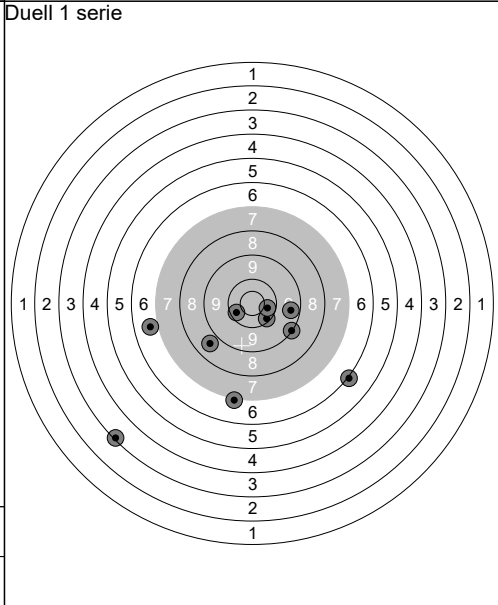

2.54s	8.1 ↓
2.35s	10.2 →
2.29s	10.6x ↙
2.35s	6.3 ↓
2.31s	10.0 →
2.49s	8.6 ←
2.14s	8.7 ↓
2.21s	9.8 ↓
2.22s	10.5x ↓
2.12s	10.6x →
Serie	89 (3x)
Total	374 (12x)

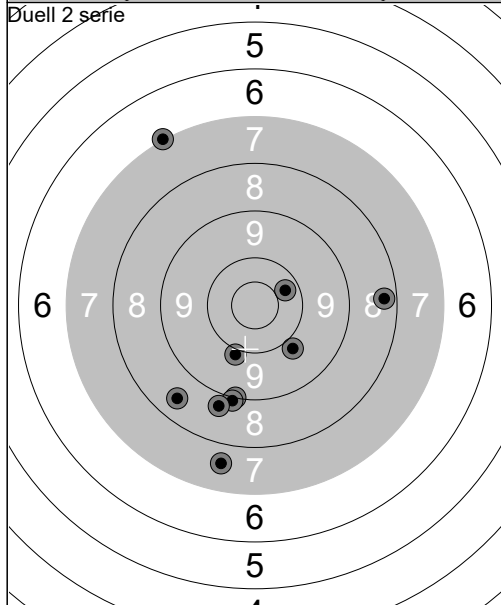

2.47s	10.4 ↓
2.38s	9.7 ↓
2.18s	10.6x →
2.27s	10.0 ↓
2.38s	9.1 ↓
2.44s	10.0 ↓
2.29s	10.4 ↓
2.20s	8.8 ↗
2.27s	9.9 ↓
2.29s	9.6 →
Serie	94 (1x)
Total	468 (13x)

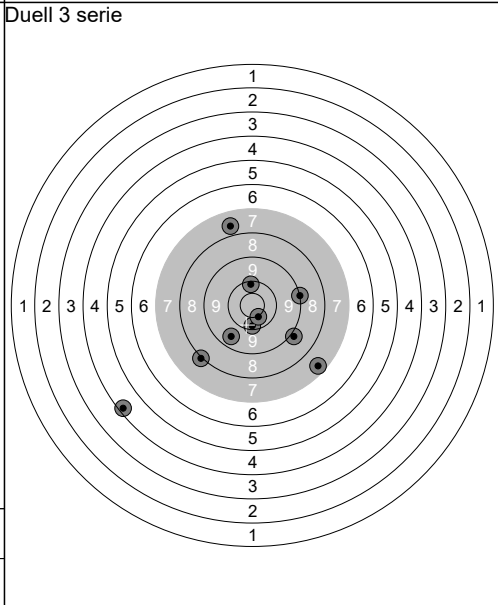

2.41s	8.9 →
2.23s	10.5x ↓
2.31s	10.7x ↓
2.19s	9.9 →
2.08s	10.5x ↑
2.50s	9.1 ↑
2.19s	7.0 ↓
2.24s	9.4 ↓
2.20s	10.0 →
2.23s	10.2 ↓
Serie	92 (3x)
Total	560 (16x)

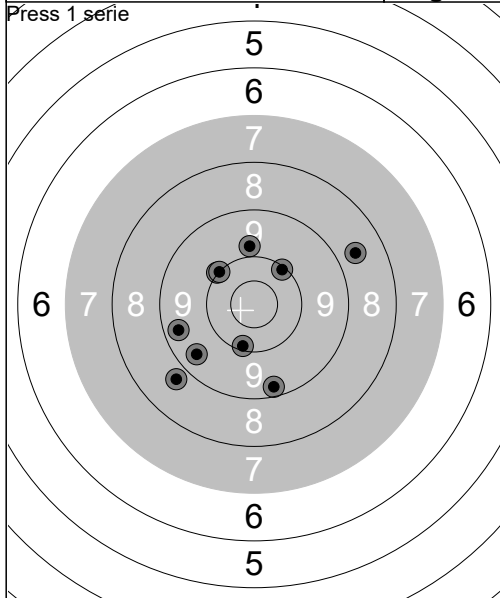

1:	10.1	↗
2:	10.0	↖
3:	9.4	←
4:	10.0	↖
5:	9.5	↙
1:46m	10.1	↘
2:21m	8.6	↗
2:50m	9.8	↑
3:23m	9.3	↘
4:00m	8.8	↙
Serie	92 (0x)	
Total	92 (0x)	

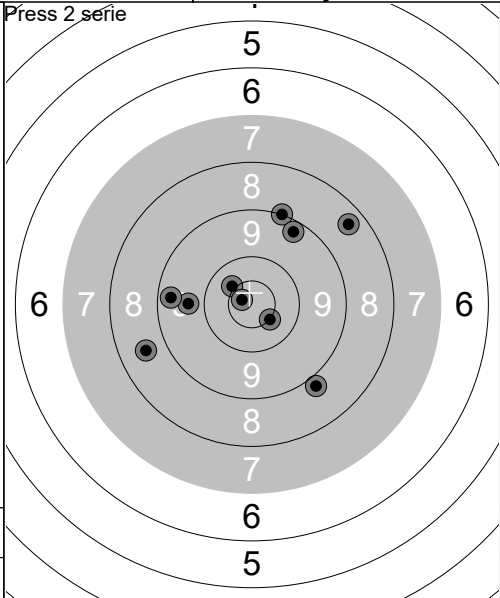

1:	9.7	←
2:	9.1	↑
3:	8.9	↘
4:	9.4	←
5:	10.5x	↘
2:03m	10.4x	↖
2:38m	9.3	↑
3:09m	8.4	↗
3:41m	10.7x	↖
4:13m	8.6	←
Serie	90 (3x)	
Total	182 (3x)	

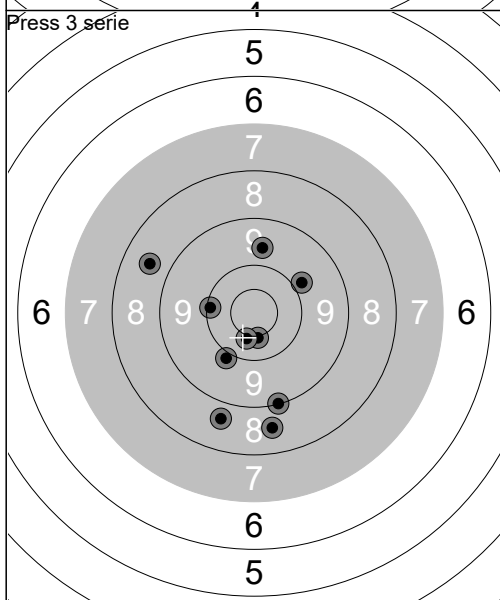

1:	9.1	↘
2:	9.7	↑
3:	8.7	↘
4:	8.6	↖
5:	10.5x	↘
3:09m	10.4x	↘
3:34m	8.6	↘
4:02m	9.9	↗
4:29m	10.1	←
5:00m	9.9	↘
Serie	90 (2x)	
Total	272 (5x)	

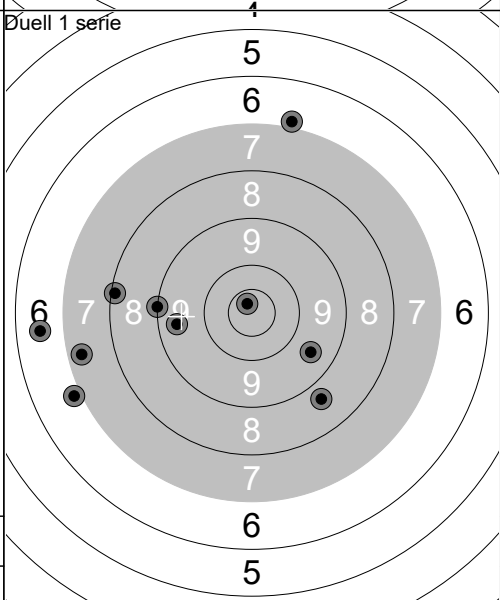

2:27s	8.7	↑
2:54s	9.8	↘
2:35s	10.2	←
2:40s	10.8x	↑
2:25s	8.5	←
2:31s	9.4	←
2:34s	9.0	←
2:22s	10.2	↘
2:41s	8.7	←
2:22s	10.0	←
Serie	91 (1x)	
Total	363 (6x)	

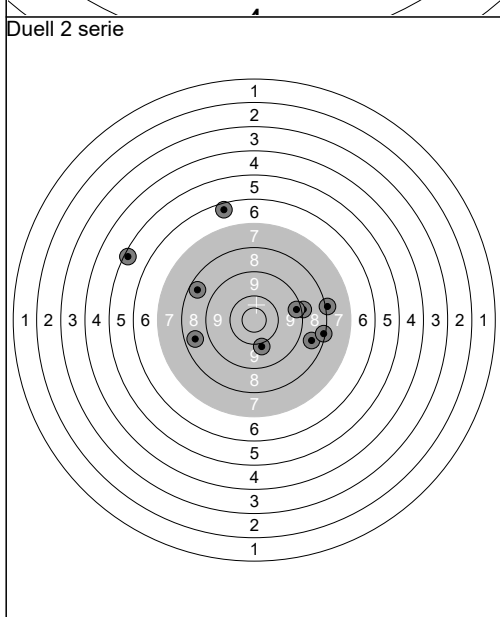

2:20s	9.3	→
2:34s	8.3	↑
2:37s	10.0	→
2:49s	10.1	→
2:35s	7.6	↖
2:57s	9.7	←
2:70s	10.4	↘
2:29s	9.6	↖
2:17s	9.7	→
2:29s	9.4	→
Serie	90 (0x)	
Total	453 (6x)	

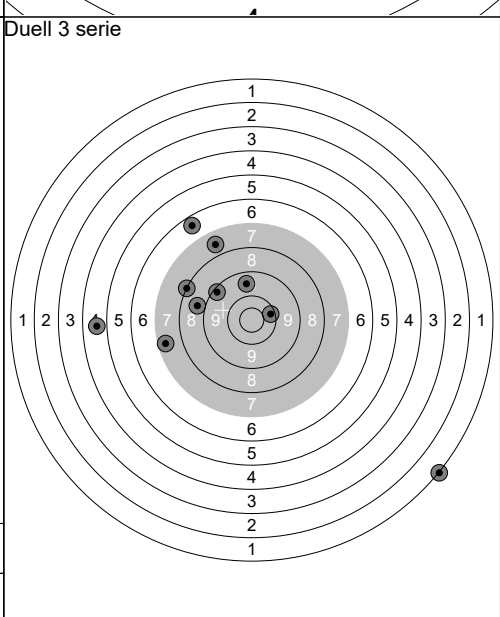

2:50s	5.0	↘
2:36s	9.4	↖
2:64s	10.1	↖
2:48s	10.6x	→
2:27s	9.0	←
2:52s	8.4	↑
2:23s	9.8	←
2:70s	10.2	↑
2:62s	7.3	←
2:29s	9.1	↑
Serie	86 (1x)	
Total	539 (7x)	

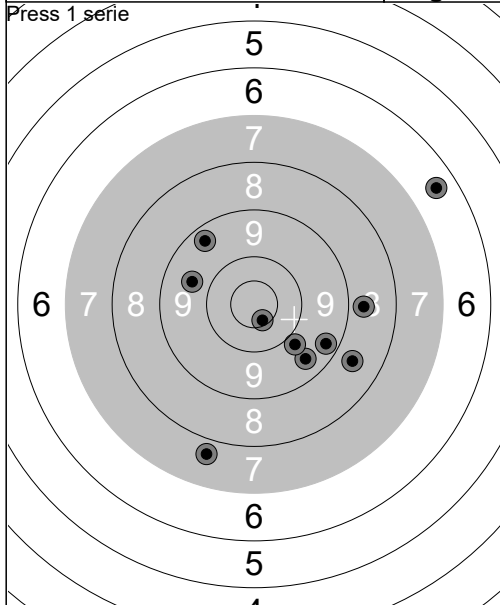

1:	9.5	↘
2:	9.4	↗
3:	9.3	↘
4:	8.7	→
3.56s	9.7	↖
1:54m	8.7	↘
2:18m	7.7	↘
2:43m	9.9	↘
3:21m	10.6x	↘
4:22m	6.5	↗
Serie	84 (1x)	
Total	84 (1x)	

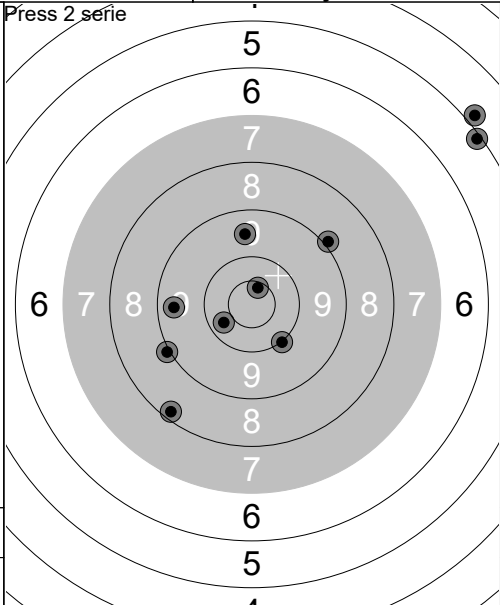

1:	9.0	↖
2:	10.0	↘
3:	4.9	↗
4:	5.1	↗
5:	9.6	↑
2:32m	10.3	↖
2:58m	9.0	↗
3:27m	10.6x	↑
3:58m	8.2	↘
4:27m	9.4	←
Serie	83 (1x)	
Total	167 (2x)	

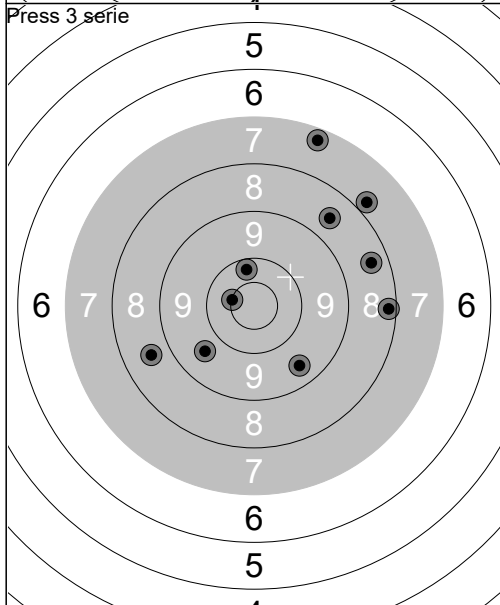

1:	8.4	→
2:	8.2	→
3:	9.5	↘
4:	8.6	↗
5:	7.8	↗
2:40m	9.6	↖
3:12m	10.5x	←
4:08m	7.3	↑
4:31m	8.7	←
4:58m	10.2	↑
Serie	84 (1x)	
Total	251 (3x)	

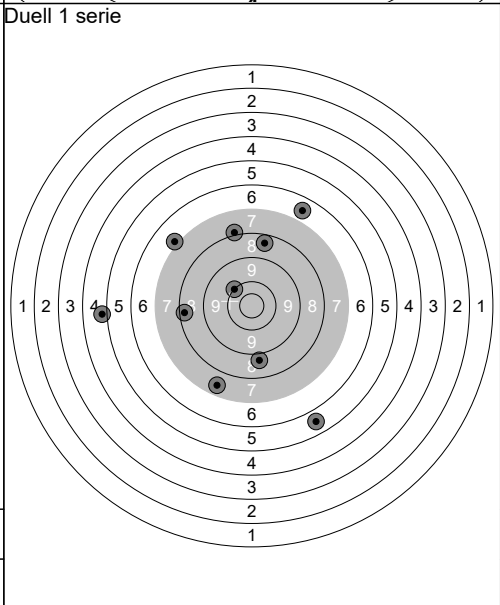

1.71s	10.5x	↖
1.91s	7.8	↘
1.88s	9.6	↑
2.06s	8.7	↖
2.50s	8.5	↗
2.02s	9.5	←
1.88s	9.3	↑
2.10s	9.8	↘
2.04s	7.4	←
2.15s	9.0	↘
Serie	85 (1x)	
Total	336 (4x)	

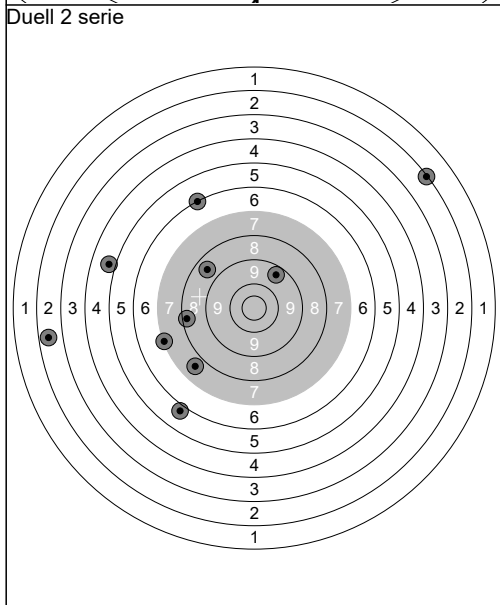

1.93s	5.7	↗
1.82s	9.5	←
1.96s	8.0	↘
1.81s	10.2	↗
1.95s	5.9	←
1.87s	8.8	←
1.87s	9.7	↖
2.36s	8.2	↗
1.87s	7.3	←
1.98s	9.1	↘
Serie	78 (0x)	
Total	414 (4x)	

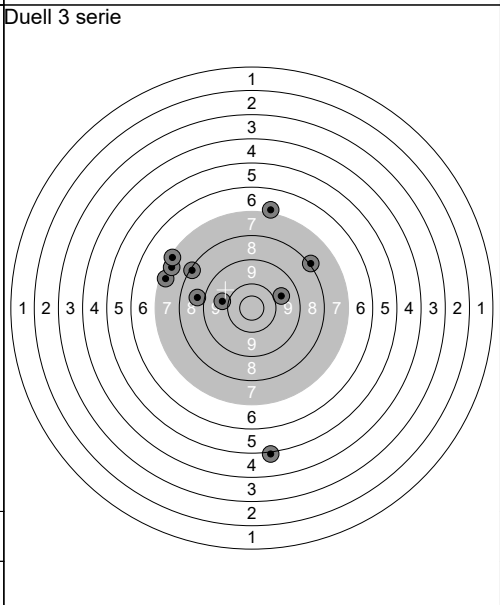

1.90s	10.3	↗
2.18s	7.5	↘
1.92s	8.7	↑
1.87s	8.9	←
1.99s	10.3	←
2.04s	8.9	↖
1.91s	9.4	↗
1.93s	9.8	←
1.85s	9.4	↖
1.91s	8.8	↖
Serie	86 (0x)	
Total	500 (4x)	

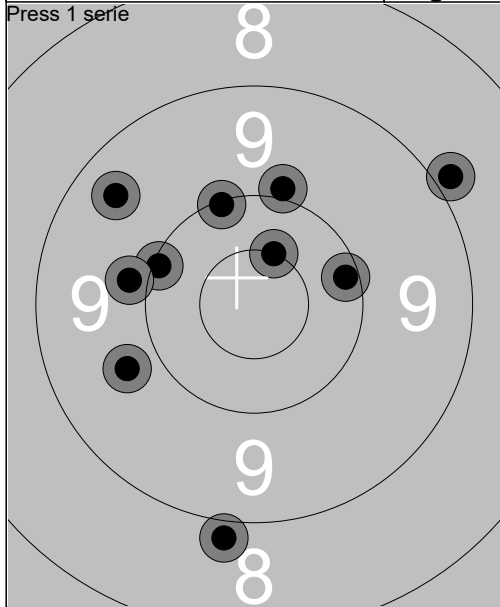

1:	10.1	↗
2:	10.0	↑
3:	9.8	↖
4:	10.2	→
5:	8.9	↓
1:41m	8.9	↗
2:05m	10.5x	↑
2:27m	10.1	↖
2:52m	9.4	↖
3:19m	9.9	↖
Serie	93 (1x)	
Total	93 (1x)	

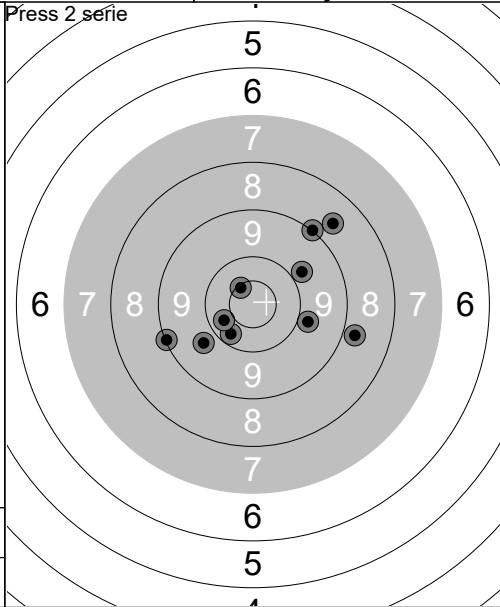

1:	8.8	→
2:	10.2	↘
3:	9.7	↖
4:	9.1	↖
5:	10.3	↖
2:19m	8.7	↗
2:42m	9.8	→
3:12m	9.0	↗
3:30m	9.8	↗
4:00m	10.6x	↖
Serie	91 (1x)	
Total	184 (2x)	

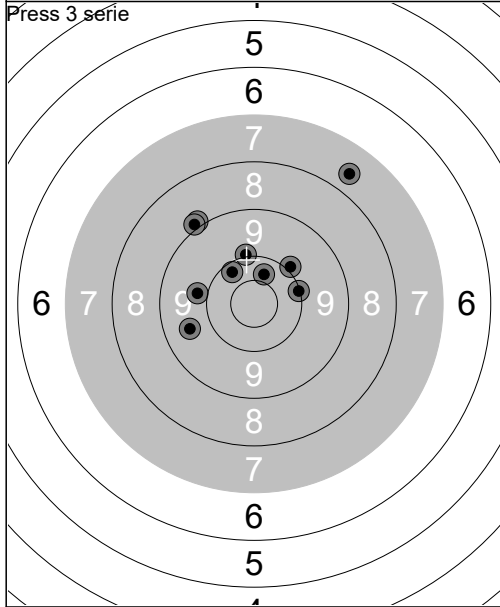

1:	7.7	↗
2:	8.9	↗
3:	9.6	↖
4:	9.0	↗
5:	10.4	↑
2:37m	10.1	→
3:00m	9.8	↖
3:23m	10.0	↗
3:48m	10.2	↖
4:13m	10.0	↑
Serie	92 (0x)	
Total	276 (2x)	

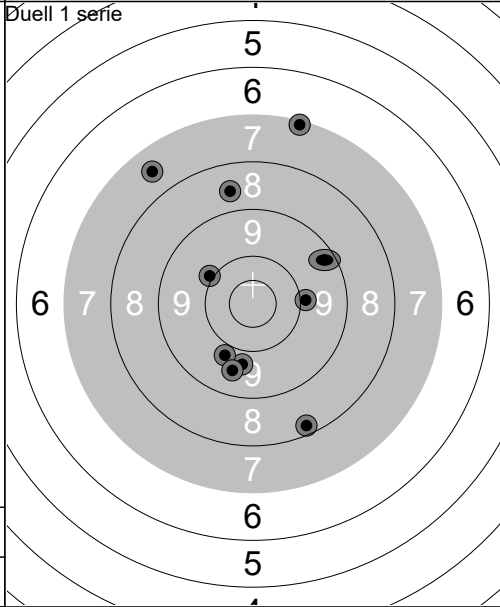

1.94s	8.8	↑
2.10s	10.3	↓
2.15s	10.4	↓
2.27s	9.5	↓
2.25s	10.4x	↖
1.92s	9.1	↖
0.14s		↖
2.69s	9.8	↑
2.24s	10.3	↓
2.25s	10.4	→
Serie	85 (1x)	
Total	361 (3x)	

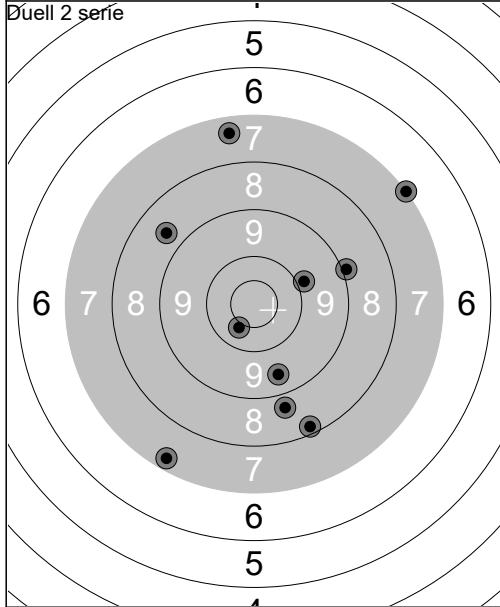

2.06s	9.0	↑
2.23s	10.4	→
2.27s	10.0	→
2.19s	9.8	↓
2.14s	9.5	↓
2.08s	8.9	↓
2.17s	8.8	↗
2.16s	10.7x	↘
2.42s	10.2	↓
2.19s	9.8	↖
Serie	92 (1x)	
Total	453 (4x)	

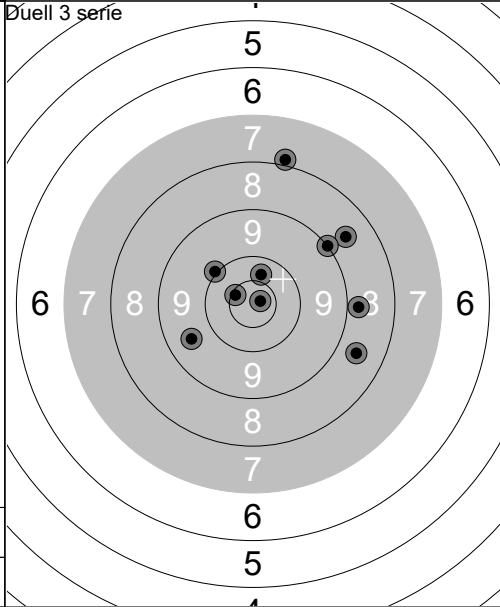

2.04s	9.7	↗
2.17s	9.8	→
2.20s	10.0	↗
2.18s	10.9x	→
2.59s	10.4x	↖
2.06s	10.6x	↑
2.16s	9.3	↑
2.14s	10.8x	↖
2.11s	9.9	→
2.31s	10.2	↖
Serie	96 (4x)	
Total	549 (8x)	

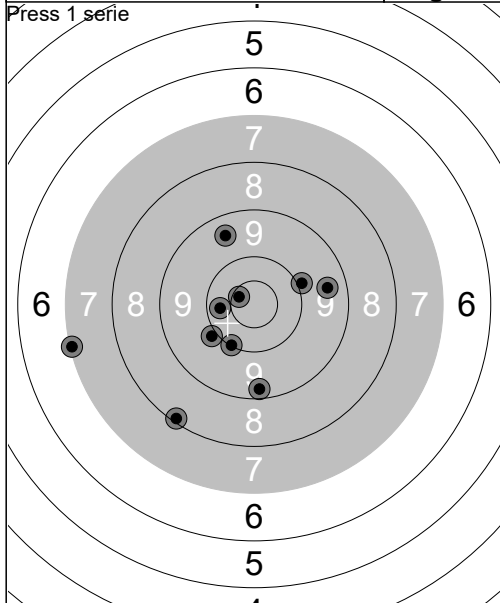

1:	9.9	↖
2:	9.5	→
3:	9.3	↓
4:	10.6x	↖
5:	9.5	↑
1:39m	10.1	↓
2:08m	10.3	←
2:29m	10.0	→
2:55m	8.1	↓
3:16m	7.1	←
Serie	91 (1x)	
Total	91 (1x)	

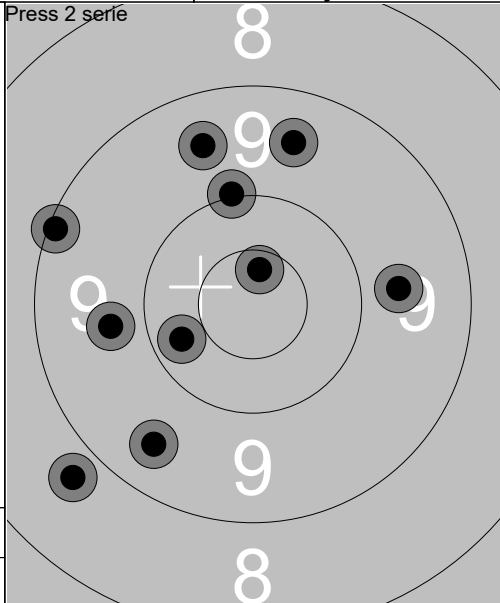

1:	10.0	↑
2:	10.3	↖
3:	9.7	←
4:	9.5	↓
5:	10.7x	↑
1:57m	8.8	↖
2:24m	9.1	←
3:05m	9.5	↑
3:37m	9.5	↑
4:07m	9.7	→
Serie	92 (1x)	
Total	183 (2x)	

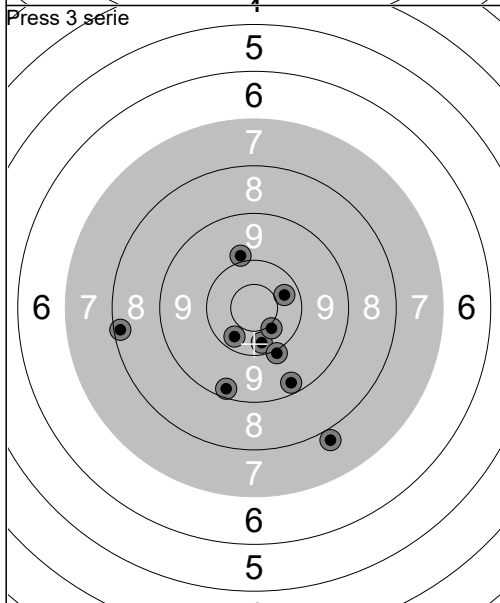

1:	10.3	↖
2:	7.8	↓
3:	8.2	←
4:	9.3	↓
5:	10.3	→
2:37m	9.9	↑
2:58m	10.3	↓
3:19m	10.4x	↘
3:38m	10.0	↓
4:00m	9.3	↓
Serie	92 (1x)	
Total	275 (3x)	

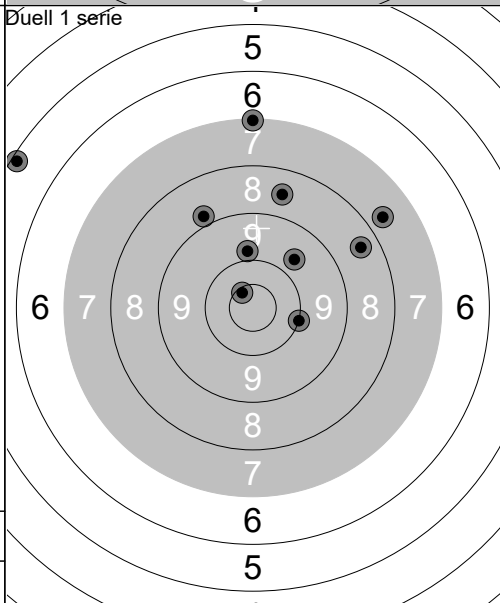

2.65s	9.9	↑
2.87s	7.6	↖
2.82s	9.7	↑
2.85s	10.3	↗
2.71s	8.8	↑
2.69s	10.5x	→
2.81s	9.2	↗
2.96s	10.4	↑
2.92s	10.8x	↖
2.85s	9.6	↗
Serie	91 (2x)	
Total	366 (5x)	

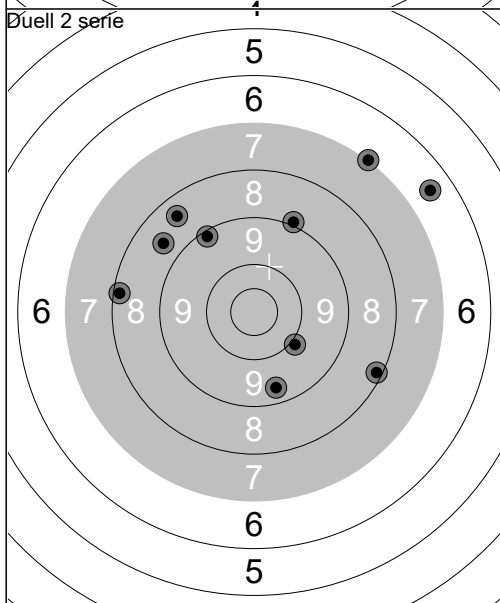

2.67s	9.8	↖
2.84s	10.1	↗
2.80s	8.8	↗
2.75s	9.5	↘
2.74s	9.6	↗
2.81s	10.4x	↘
2.70s	10.0	↑
2.78s	8.4	↗
2.56s	10.2	↓
2.78s	9.5	←
Serie	92 (1x)	
Total	458 (6x)	

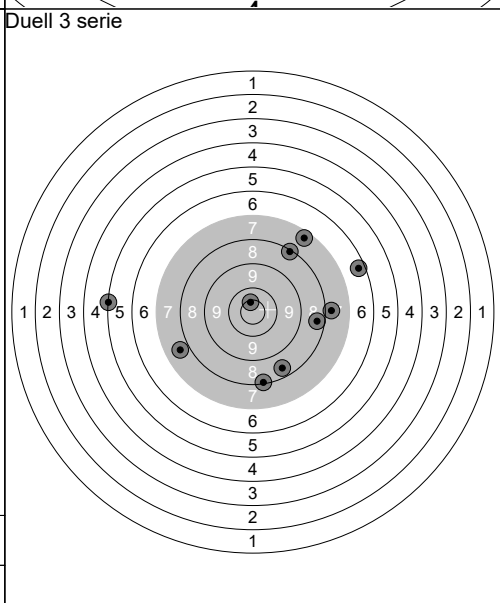

2.68s	9.6	↓
2.81s	10.8x	↑
2.65s	9.4	↓
2.96s	9.2	→
2.84s	8.3	↗
2.61s	9.6	→
2.57s	9.2	←
2.82s	9.4	↑
2.92s	7.5	←
3.00s	8.9	↗
Serie	87 (1x)	
Total	545 (7x)	

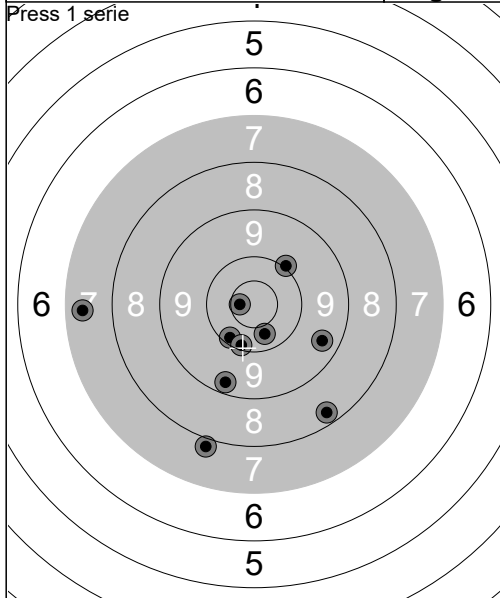

1:	7.9	↓
2:	10.7x	←
3:	10.2	↓
4:	7.4	←
8.56s	10.3	↓
1:44m	9.3	↓
2:16m	9.4	→
2:52m	10.0	↗
3:27m	10.1	↓
4:02m	8.3	↓
Serie	90 (1x)	
Total	90 (1x)	

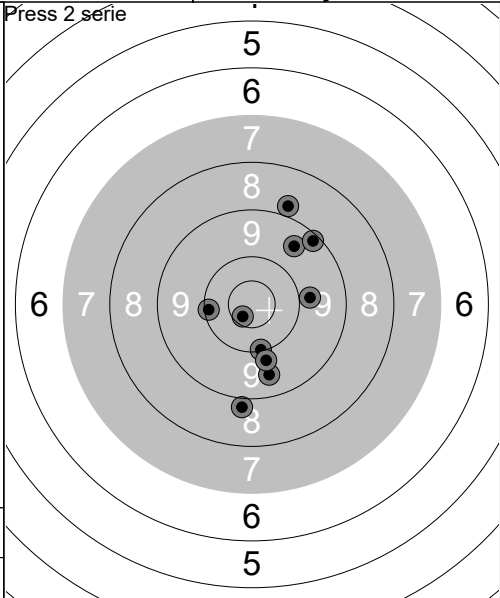

1:	9.5	↓
2:	8.8	↑
3:	9.5	↗
4:	9.8	→
5:	10.1	←
2:02m	10.1	↓
2:33m	10.7x	↙
3:02m	8.9	↓
3:39m	9.2	↗
4:20m	9.8	↓
Serie	91 (1x)	
Total	181 (2x)	

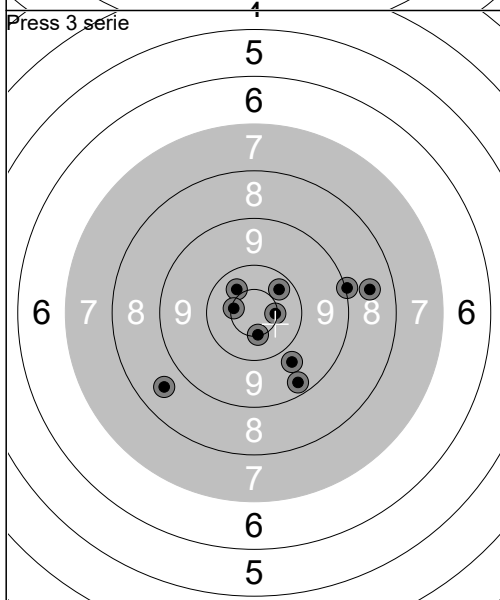

1:	8.6	→
2:	10.4	↗
3:	10.6x	→
4:	10.3	↗
5:	8.6	↙
2:39m	9.8	↓
3:09m	10.5x	←
3:43m	10.5x	↓
4:17m	9.0	→
4:49m	9.3	↓
Serie	93 (3x)	
Total	274 (5x)	

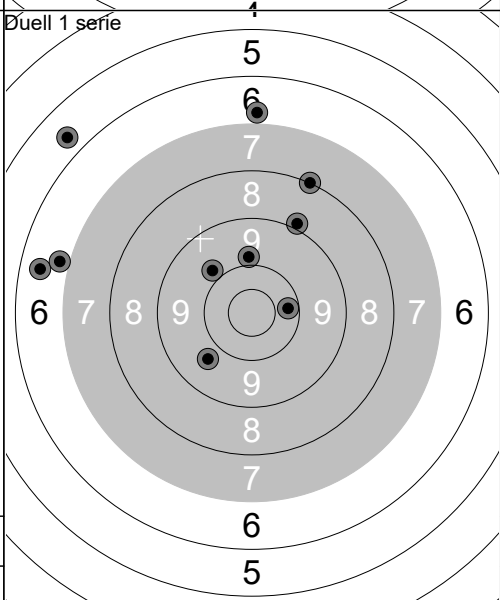

2.43s	10.4	↖
2.36s	8.6	↑
2.48s	8.4	←
2.09s	10.3	↙
2.27s	9.9	↗
2.23s	7.9	↖
2.21s	9.4	↗
2.29s	8.6	←
2.42s	10.4	↑
2.29s	10.6x	→
Serie	89 (1x)	
Total	363 (6x)	

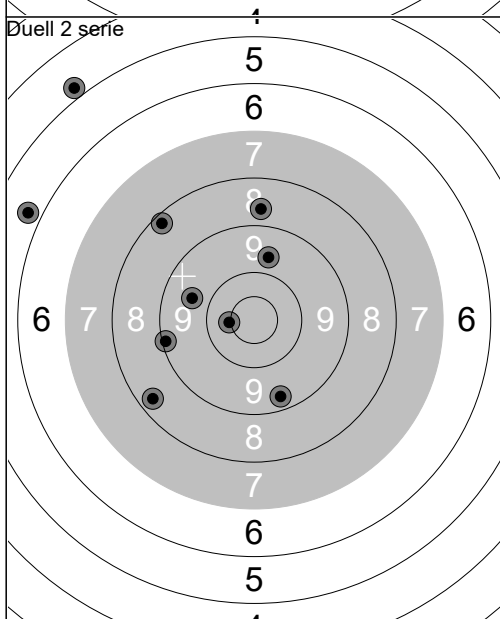

2.34s	10.3	←
2.88s	9.8	↑
2.45s	8.0	↖
2.00s	10.0	←
2.22s	9.6	↙
2.06s	9.5	↗
2.22s	7.4	↗
2.31s	10.7x	←
2.06s	10.3	↑
2.37s	10.1	↓
Serie	92 (1x)	
Total	455 (7x)	

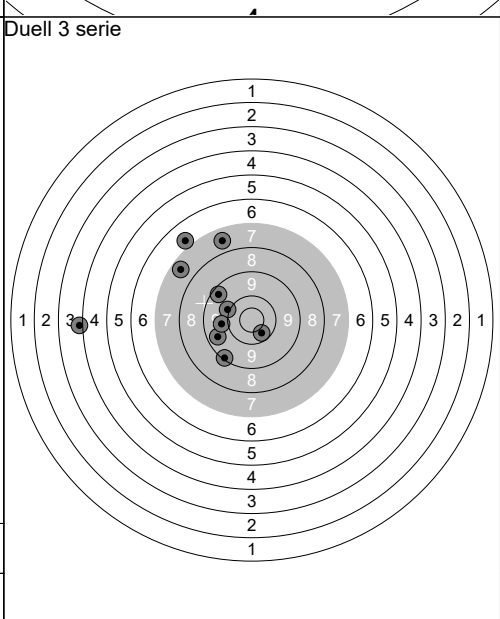

2.52s	10.6x	↓
2.23s	10.4x	↖
1.88s	9.0	↖
2.10s	6.8	←
2.29s	10.0	↙
2.29s	9.1	↑
2.29s	10.2	←
2.13s	8.6	↗
2.25s	10.3	←
2.14s	10.1	↖
Serie	92 (2x)	
Total	547 (9x)	

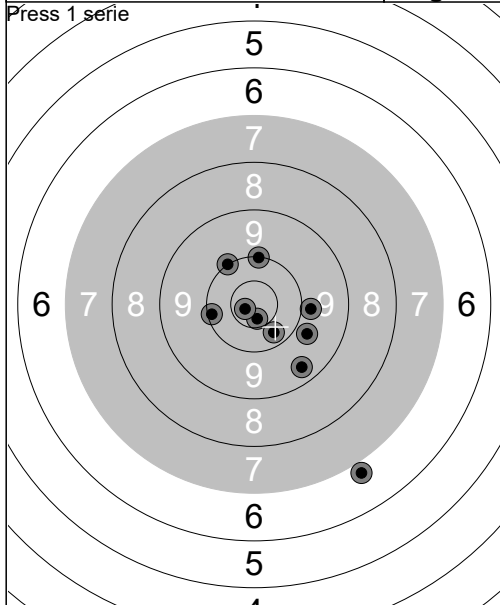

1:	6.8	↘
2:	10.0	↗
3:	10.1	←
4:	10.7x	↘
5:	10.8x	←
1:46m	9.4	↘
2:10m	9.8	↘
2:49m	10.3	↘
3:20m	10.1	↑
3:48m	9.9	→
Serie	93 (2x)	
Total	93 (2x)	

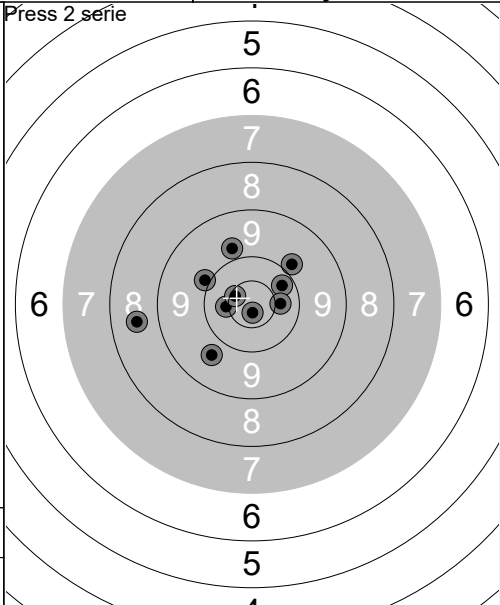

1:	9.9	↗
2:	9.7	↘
3:	10.5x	←
4:	8.6	←
5:	10.3	↗
2:00m	10.6x	↖
2:30m	10.4x	→
2:56m	9.8	↑
3:55m	10.8x	↘
4:20m	10.0	↖
Serie	95 (4x)	
Total	188 (6x)	

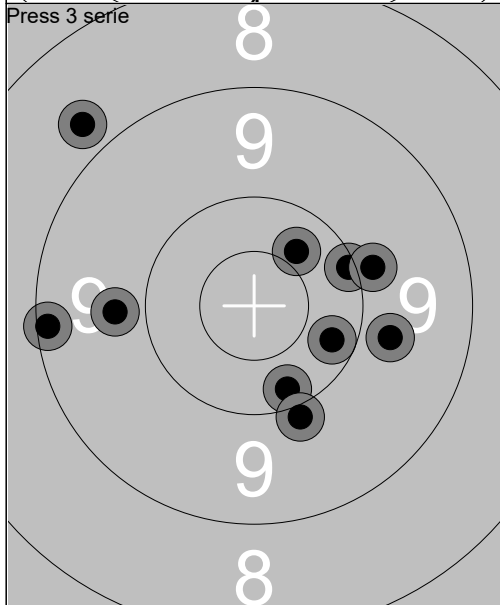

1:	10.2	↘
2:	9.2	←
3:	10.2	↘
4:	10.4	↗
5:	10.1	↘
2:38m	9.8	↘
3:10m	9.8	←
3:41m	10.0	↘
4:44m	8.8	↗
10:	9.9	↘
Serie	94 (0x)	
Total	282 (6x)	

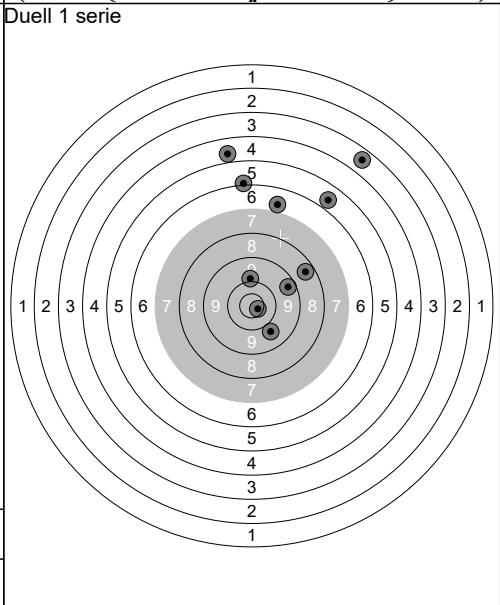

2.71s	10.3	↘
2.93s	8.6	↑
2.67s	6.5	↗
2.76s	9.6	↗
2.88s	10.4	↑
3.03s	7.9	↗
2.72s	7.3	↑
3.06s	10.1	↗
2.96s	8.1	↑
2.88s	10.8x	↘
Serie	85 (1x)	
Total	367 (7x)	

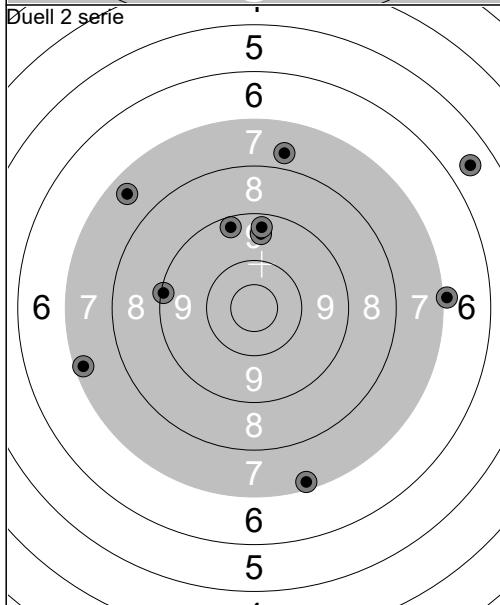

2.38s	10.2	↑
2.88s	9.2	↑
2.67s	10.1	↑
2.70s	9.0	↗
2.50s	8.9	←
2.57s	8.7	→
2.71s	8.9	↘
2.70s	10.1	↑
2.68s	7.8	↗
2.91s	10.0	←
Serie	89 (0x)	
Total	456 (7x)	

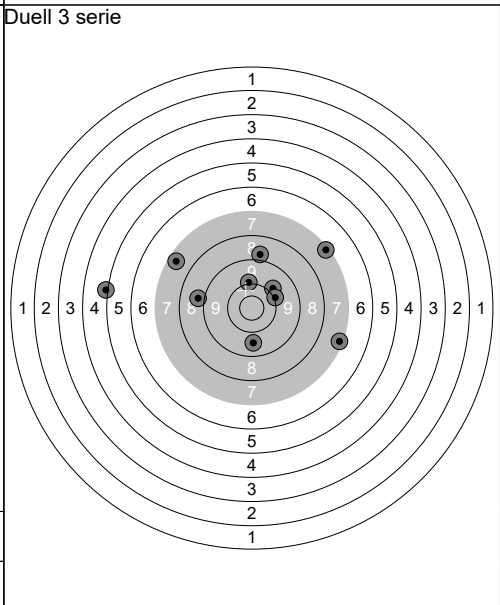

2.85s	10.4x	↑
2.91s	10.4	↗
2.76s	9.9	↑
2.50s	9.0	↖
2.46s	8.8	↗
2.62s	10.3	↘
2.85s	8.9	↘
2.80s	9.9	←
2.61s	7.5	←
2.64s	10.4x	↗
Serie	90 (2x)	
Total	546 (9x)	

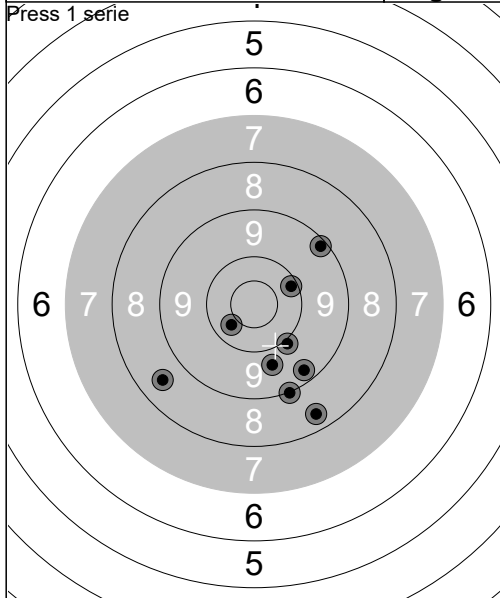

1:	8.6	↙
0.00s	10.2	
3:	10.4	↙
4:	9.3	↘
23.5s	9.0	↘
1:47m	10.0	↘
2:54m	9.2	↗
3:26m	10.2	↗
4:04m	8.4	↘
4:33m	9.7	↘
Serie	92 (0x)	
Total	92 (0x)	

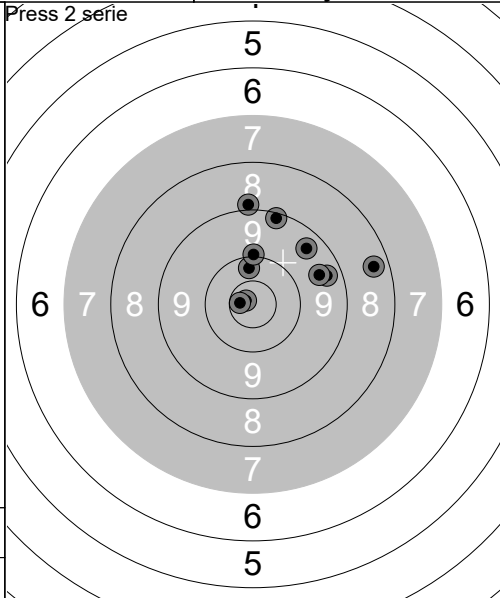

1:	10.3	↑
2:	10.0	↑
3:	8.9	↑
4:	9.2	↑
5:	9.4	→
2:09m	9.4	↗
2:48m	10.8x	↖
3:40m	8.4	→
4:11m	10.7x	↖
4:44m	9.5	↗
Serie	92 (2x)	
Total	184 (2x)	

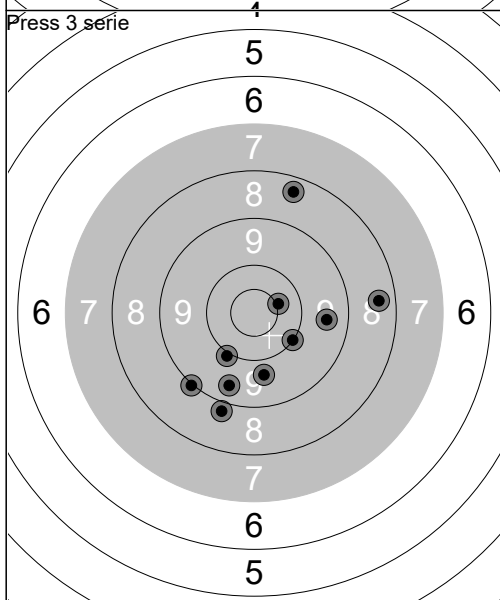

1:	9.4	↘
2:	9.7	↘
3:	9.5	→
4:	8.4	↑
5:	9.0	↘
2:46m	10.5x	↗
3:28m	8.4	→
4:17m	10.0	↘
4:59m	10.0	↘
10:	8.9	↘
Serie	90 (1x)	
Total	274 (3x)	

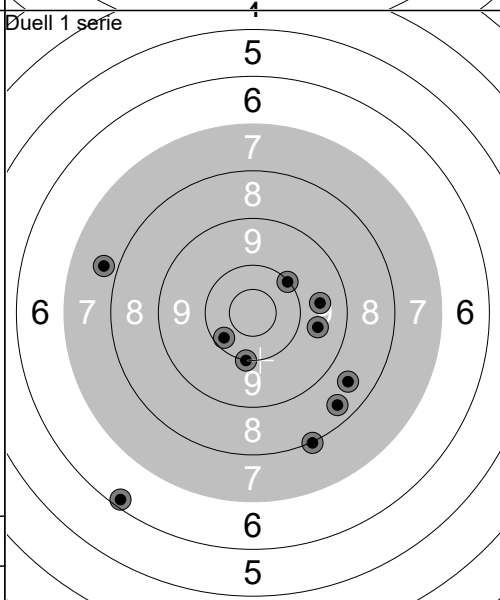

2.74s	9.6	↘
3.12s	9.7	↘
2.82s	9.4	↘
2.86s	10.3	→
3.00s	10.5x	↗
2.87s	10.5x	↘
3.04s	10.3	→
2.81s	9.2	↖
2.67s	8.2	↘
2.87s	10.6x	↖
Serie	94 (3x)	
Total	368 (6x)	

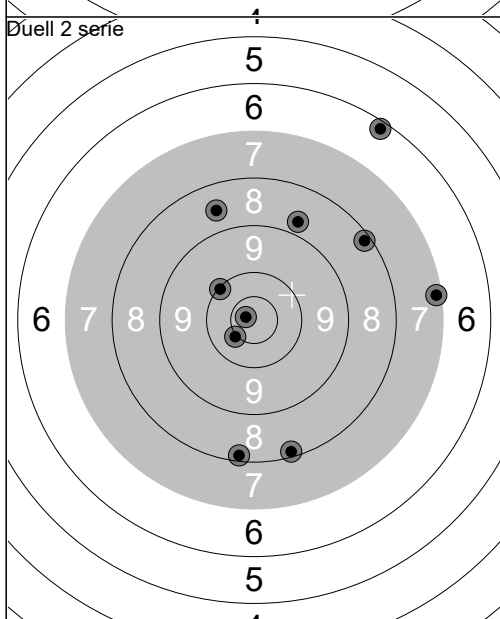

2.79s	8.2	↗
3.12s	10.9x	↖
2.78s	10.7x	↖
2.80s	10.5x	↖
2.84s	8.8	→
2.65s	9.7	↑
2.89s	9.5	↘
2.86s	9.8	↗
2.89s	9.5	↗
2.85s	9.5	↘
Serie	91 (3x)	
Total	459 (9x)	

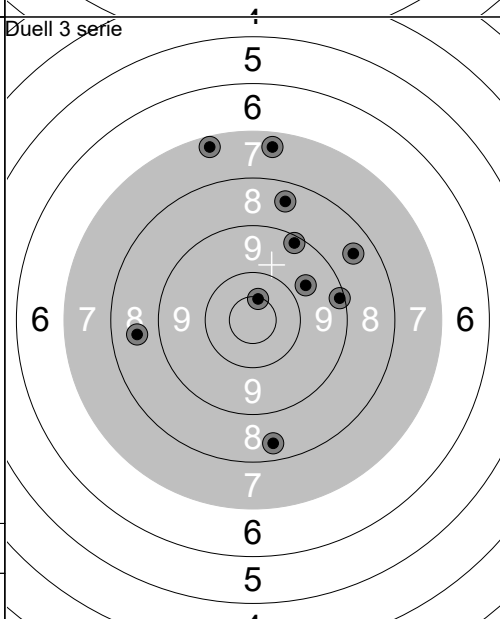

2.76s	8.9	↑
2.84s	10.3	↗
2.85s	9.7	↖
2.77s	9.6	↑
2.73s	9.0	↑
2.93s	10.7x	↑
3.05s	10.1	→
2.91s	9.6	↘
2.85s	10.1	↗
2.73s	9.7	↗
Serie	93 (1x)	
Total	552 (10x)	

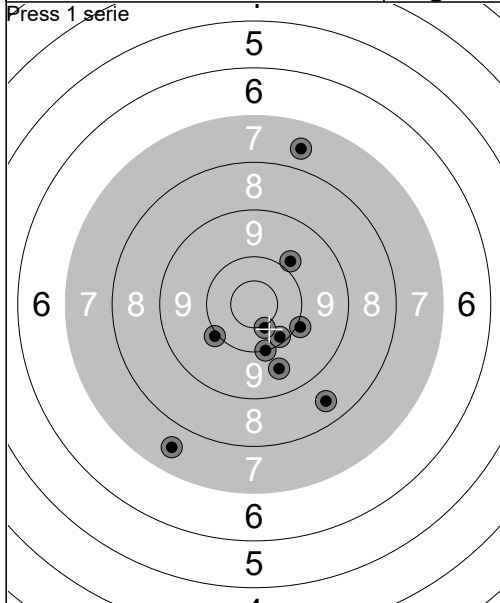

1:	7.6	↘
2:	10.0	↙
3:	7.6	↗
4:	9.9	↗
5:	10.0	↘
1:51m	10.2	↘
2:22m	10.5x	↘
2:54m	8.5	↘
3:18m	9.6	↘
3:51m	10.0	↗
Serie	90 (1x)	
Total	90 (1x)	

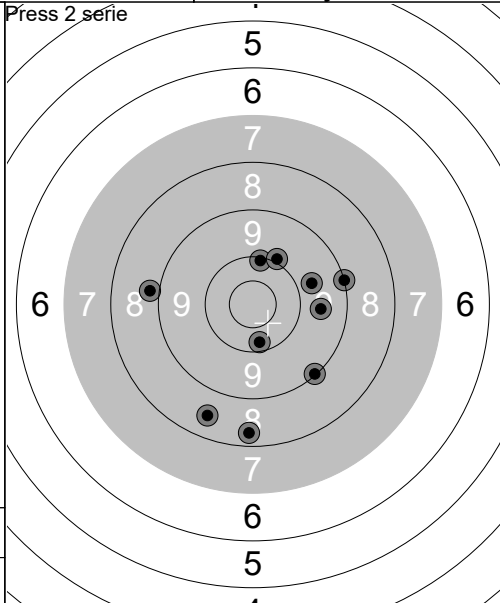

1:	8.5	↘
2:	9.1	→
3:	10.2	↘
4:	8.3	↘
5:	8.9	←
2:05m	10.1	↑
2:50m	9.6	→
3:29m	9.1	↘
3:58m	10.0	↗
4:34m	9.7	→
Serie	90 (0x)	
Total	180 (1x)	

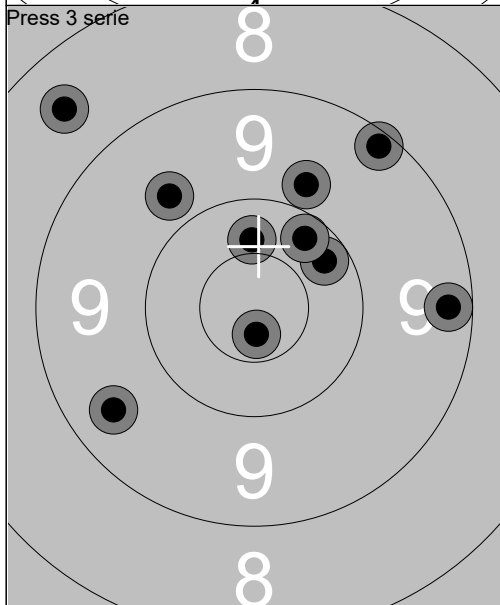

1:	10.7x	↘
2:	9.8	↗
3:	9.8	↖
4:	9.3	→
5:	10.2	↗
2:54m	9.5	↙
3:27m	8.5	↖
4:03m	10.4	↑
4:43m	10.2	↗
5:19m	9.2	↗
Serie	93 (1x)	
Total	273 (2x)	

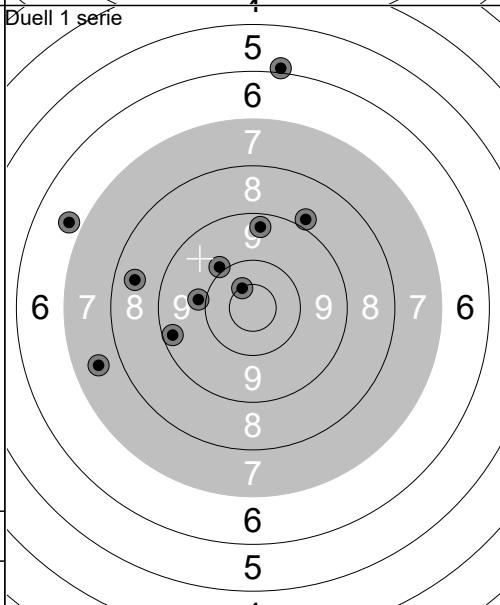

2.20s	9.1	↙
2.58s	10.4	↙
2.50s	8.6	↙
2.79s	10.1	↙
2.67s	10.4	↖
2.41s	8.1	↑
2.44s	9.9	↗
2.71s	9.7	↙
2.50s	10.7x	↖
2.50s	10.1	↑
Serie	93 (1x)	
Total	366 (3x)	

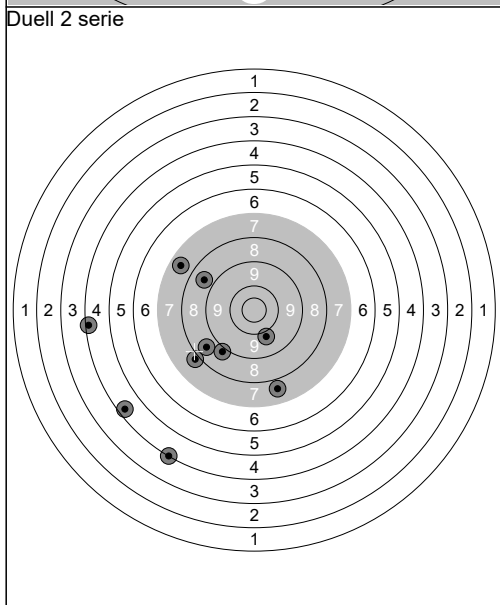

2.41s	9.1	↘
2.33s	7.0	←
2.59s	9.7	↙
2.59s	9.9	↙
2.25s	10.4	↘
2.43s	7.0	↙
2.40s	9.1	↖
2.42s	9.8	↖
2.47s	9.3	↙
2.43s	6.9	↘
Serie	84 (0x)	
Total	450 (3x)	

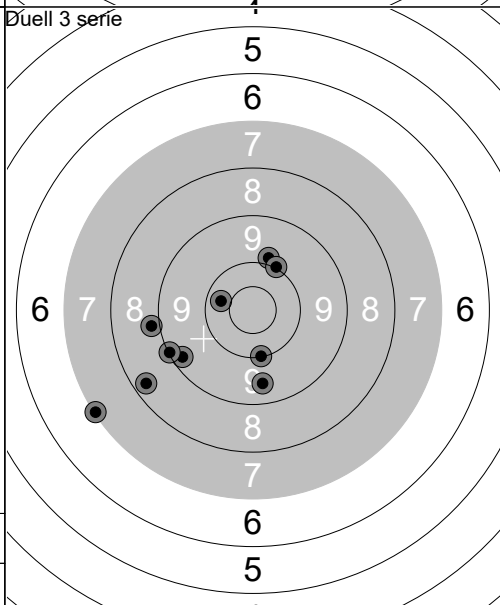

2.52s	10.2	↘
2.52s	8.8	↙
2.38s	10.5x	↘
2.65s	10.4	↑
2.66s	10.6x	↙
2.40s	9.6	↙
2.49s	10.1	↙
2.58s	10.0	↙
2.71s	9.9	←
2.75s	10.5x	↗
Serie	96 (3x)	
Total	546 (6x)	

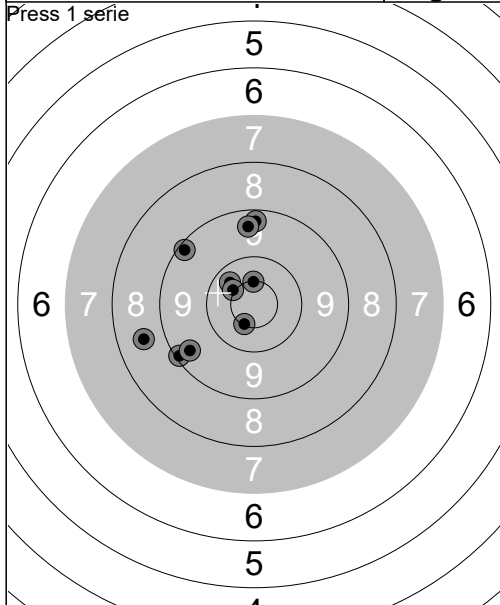

1:	10.5x	↑
2:	10.3	↖
3:	10.5x	↖
4:	10.5x	↘
8.56s	9.2	↖
1:46m	8.6	←
2:16m	9.1	↖
2:46m	9.4	↖
3:24m	9.3	↑
3:51m	9.4	↑
Serie	93 (3x)	
Total	93 (3x)	

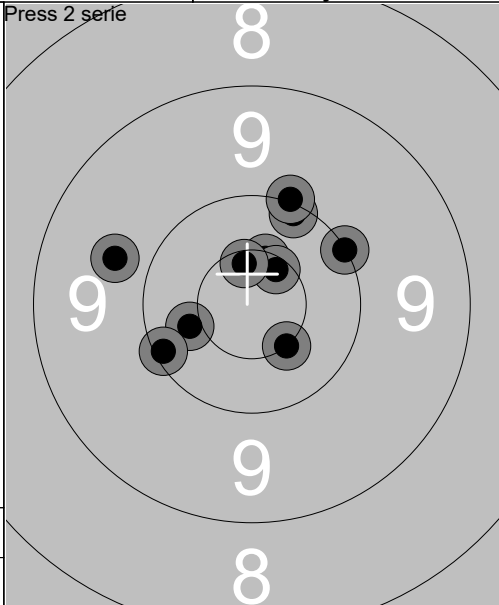

1:	10.4x	←
2:	10.6x	↑
3:	10.5x	↘
4:	10.1	←
5:	10.1	↑
2:02m	9.7	←
2:30m	10.6x	↗
3:24m	10.6x	↑
3:44m	10.0	↑
4:10m	10.1	↗
Serie	99 (5x)	
Total	192 (8x)	

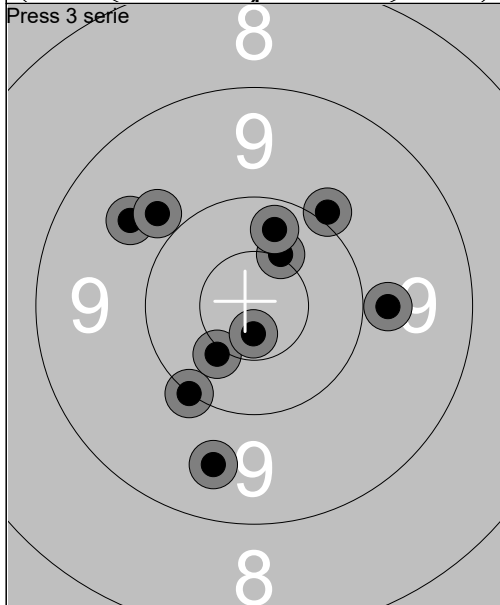

1:	10.0	↗
2:	9.7	↖
3:	9.6	↓
4:	10.5x	↑
5:	9.8	→
3:06m	10.3	↑
3:31m	10.1	↘
3:53m	9.8	↖
4:20m	10.4x	↘
4:46m	10.7x	↓
Serie	96 (3x)	
Total	288 (11x)	

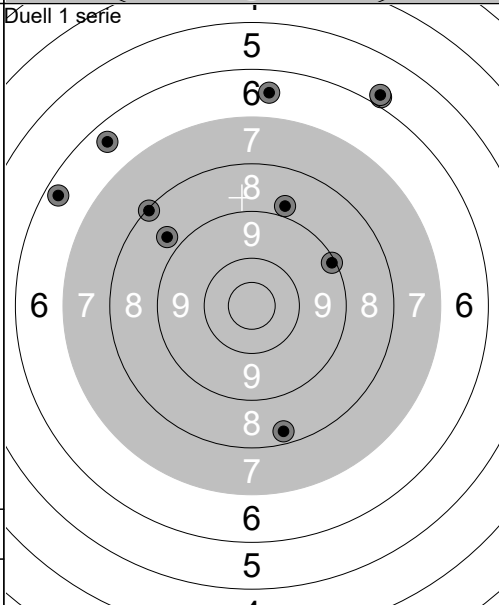

2.35s	9.4	↖
2.56s	8.0	↑
2.44s	10.0	↗
2.76s	8.0	↑
3.09s	8.3	↖
2.60s	8.4	↖
2.48s	8.4	↑
2.50s	9.6	↓
2.66s	9.9	↑
2.64s	9.8	↖
Serie	86 (0x)	
Total	374 (11x)	

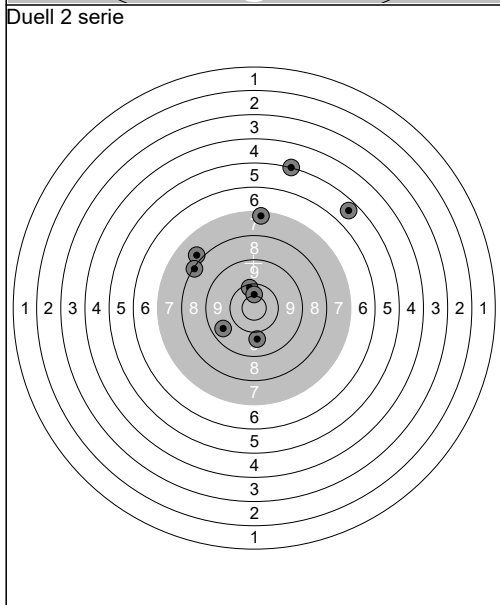

2.24s	8.9	↑
2.42s	7.5	↑
2.34s	10.5x	↑
2.46s	9.2	↖
2.38s	9.4	↖
	--	
2.47s	10.7x	↑
2.74s	7.8	↗
2.49s	10.3	↓
2.38s	10.2	↖
Serie	80 (2x)	
Total	454 (13x)	

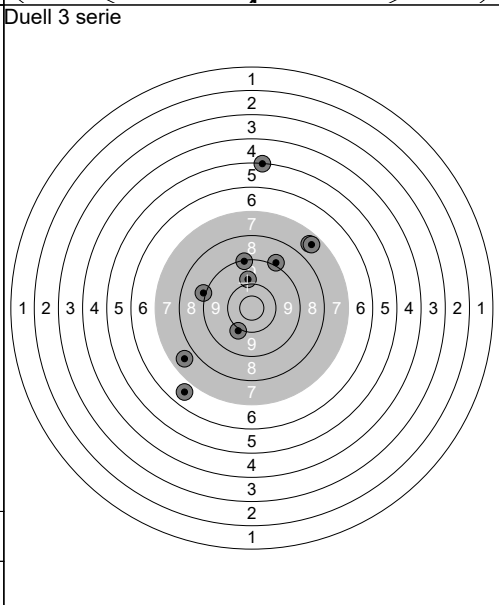

2.42s	9.0	↗
2.42s	10.4	↑
2.23s	9.1	↖
2.56s	10.0	←
2.35s	10.4x	↘
2.74s	7.5	↑
2.41s	10.0	↑
2.20s	8.5	↘
2.38s	9.9	↑
2.54s	9.0	↗
Serie	91 (1x)	
Total	545 (14x)	