

1:	7.8	↗
2:	7.4	↖
3:	9.3	→
4:	8.5	↙
5:	8.4	↘
6:	8.3	↑
7:	6.2	→
8:	7.5	↑
9:	7.7	↗
10:	8.7	↙
Serie		75 (0x)
Total		75 (0x)

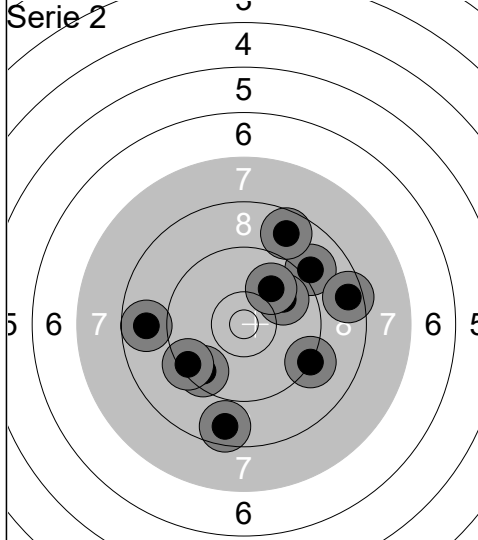

1:	8.8	←
2:	9.0	↗
3:	9.9	↗
4:	9.2	↘
5:	9.6	↙
6:	8.6	↓
7:	9.9	↗
8:	9.4	↙
9:	8.7	↗
10:	8.5	→
Serie		86 (0x)
Total		161 (0x)

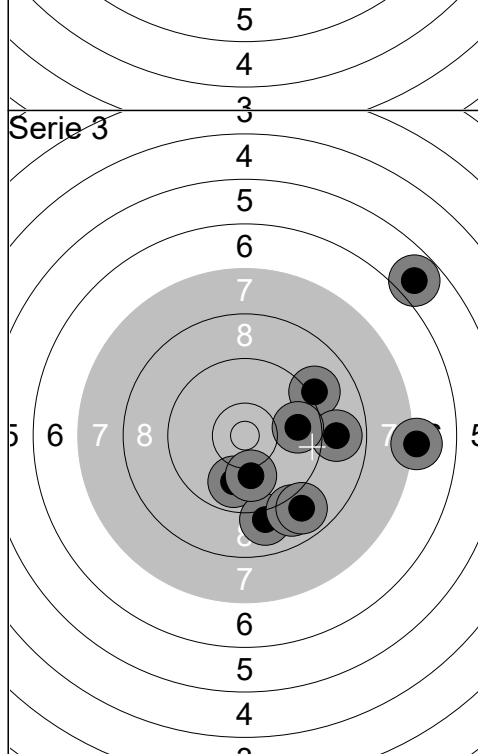

1:	9.9	↓
2:	9.1	↗
3:	9.0	↓
4:	5.8	↗
5:	8.9	→
6:	10.0	↓
7:	9.7	→
8:	9.0	↓
9:	7.1	→
10:	8.9	↘
Serie		83 (0x)
Total		244 (0x)

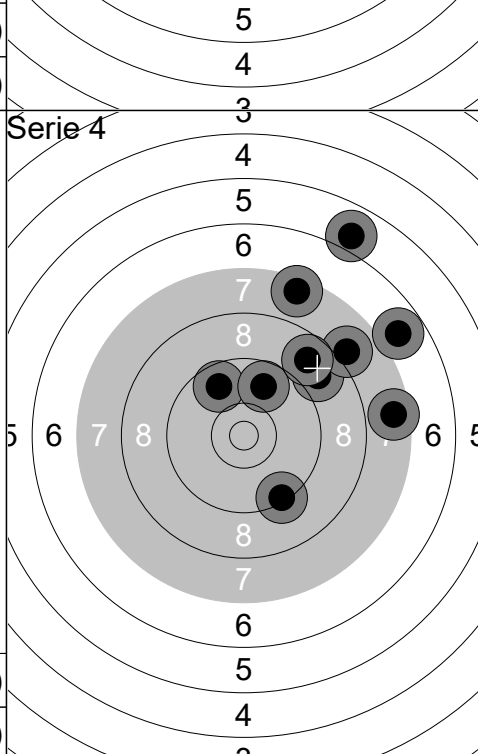

1:	7.6	→
2:	9.3	↘
3:	8.8	↗
4:	8.0	↗
5:	7.5	↑
6:	6.8	↗
7:	9.7	↖
8:	9.8	↑
9:	8.7	↗
10:	5.9	↗
Serie		76 (0x)
Total		320 (0x)

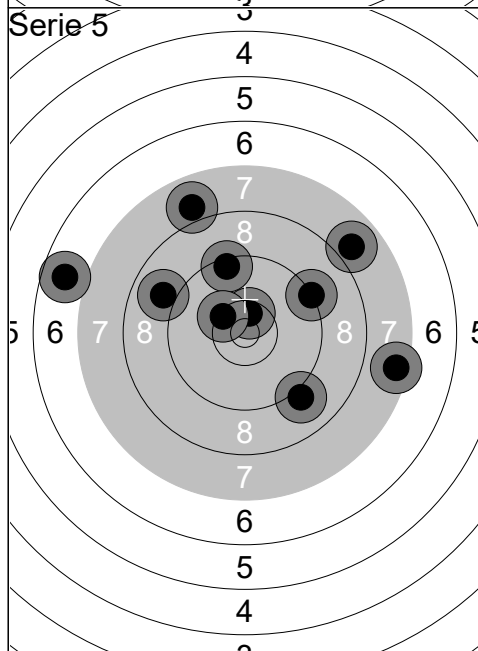

1:	9.4	↑
2:	9.2	↗
3:	10.5x	↑
4:	8.9	←
5:	7.9	↑
6:	7.5	→
7:	6.7	←
8:	7.9	↗
9:	9.0	↘
10:	10.3	↖
Serie		82 (1x)
Total		402 (1x)

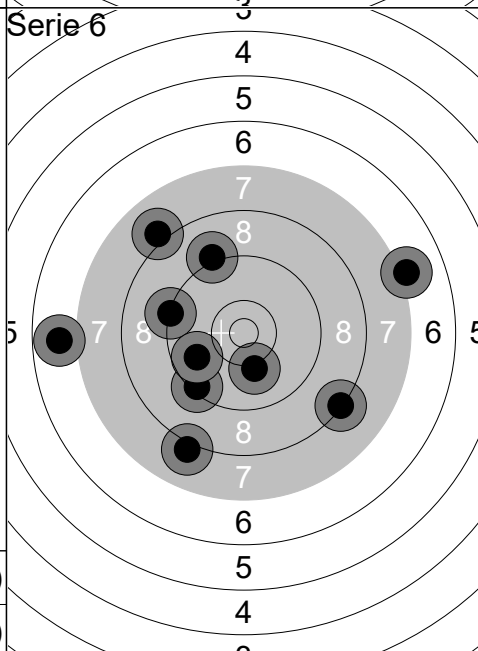

1:	8.1	↓
2:	9.1	↑
3:	7.1	→
4:	6.8	←
5:	9.3	↙
6:	8.3	↘
7:	10.1	↓
8:	9.3	←
9:	8.0	↖
10:	9.8	←
Serie		83 (0x)
Total		485 (1x)

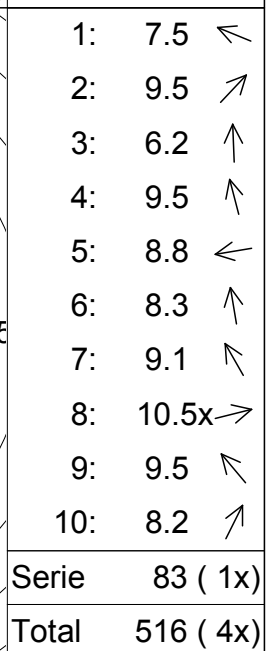
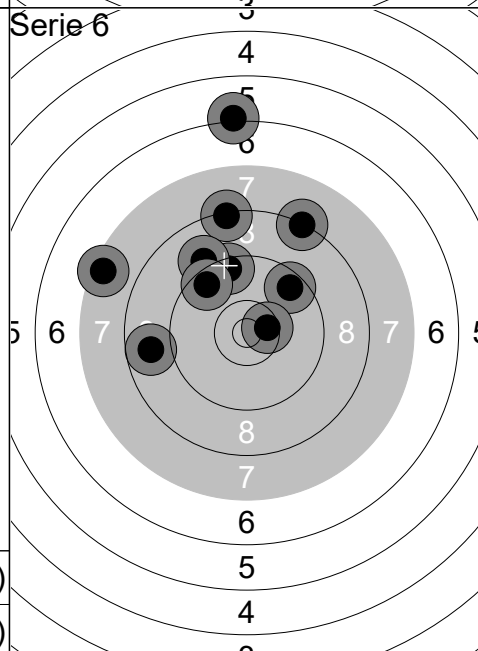
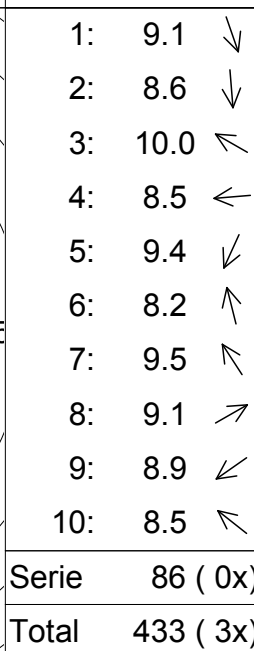
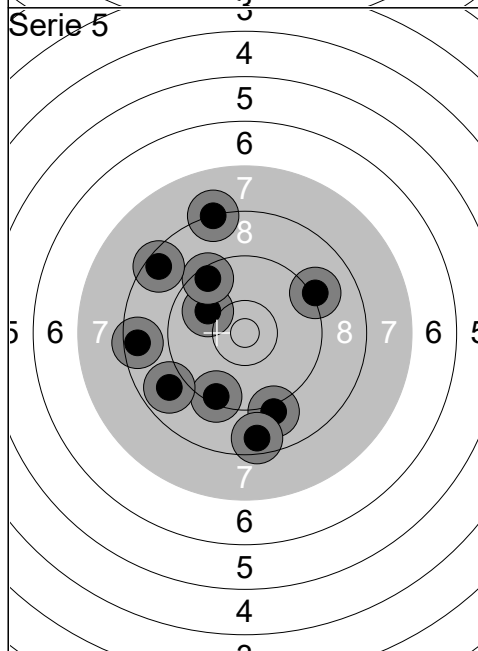
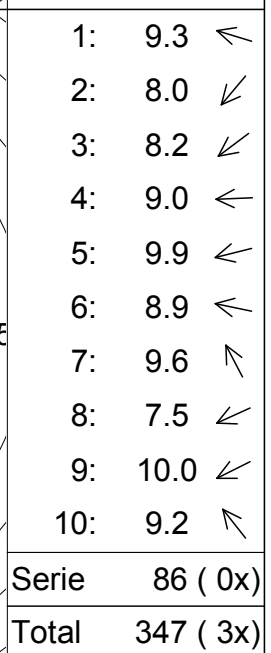
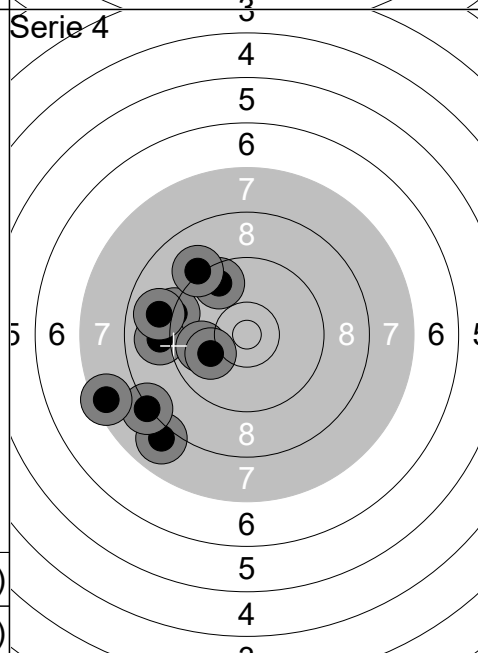
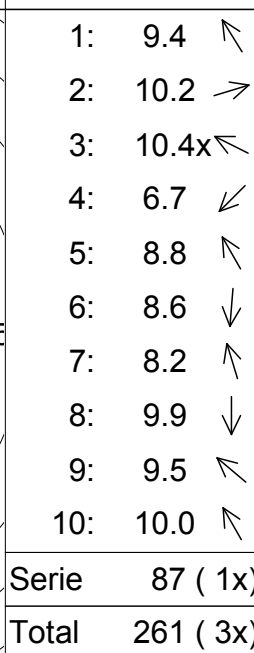
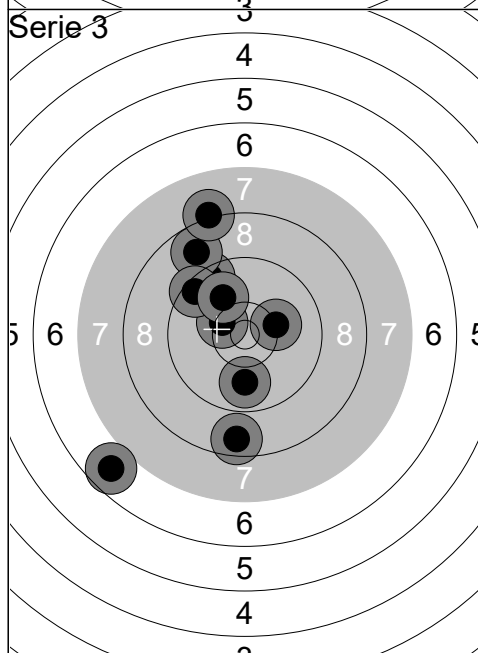
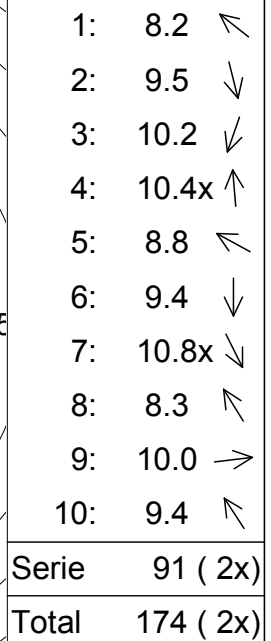
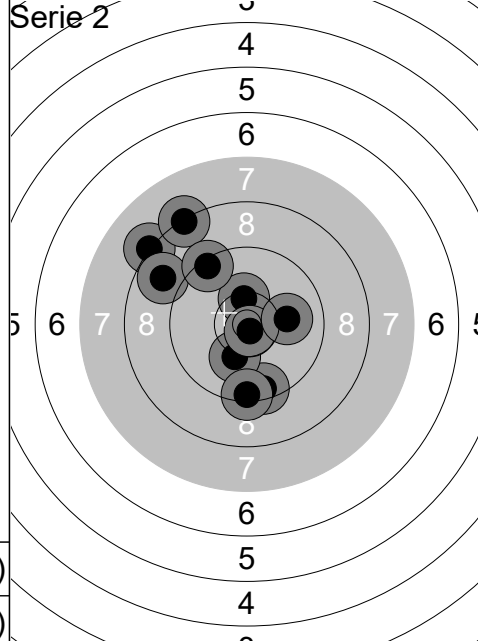
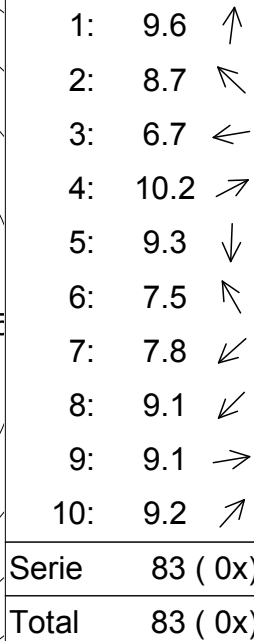
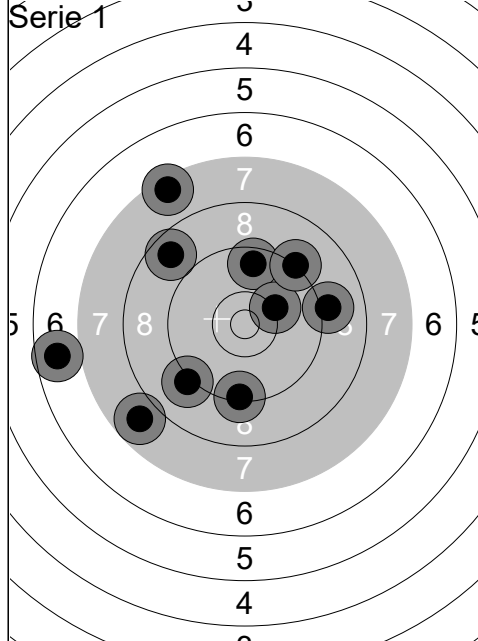

Serie 1

1:	7.2	↘
2:	9.9	↓
3:	8.3	↙
4:	7.9	↑
5:	☐	
6:	4.5	↙
7:	0.0	↗
8:	5.8	←
9:	10.6x	↓
10:	5.8	↙
Serie		55 (1x)
Total		55 (1x)

Serie 2

1:	7.0	↓
2:	9.2	↗
3:	10.1	↘
4:	9.7	←
5:	9.5	↖
6:	5.4	↑
7:	4.3	↙
8:	9.8	←
9:	10.2	↙
10:	8.7	↑
Serie		80 (0x)
Total		135 (1x)

Serie 3

1:	8.3	↖
2:	6.8	↑
3:	3.0	→
4:	7.9	↘
5:	8.9	↓
6:	8.8	←
7:	7.1	←
8:	6.2	↖
9:	5.4	→
10:	6.7	↓
Serie		64 (0x)
Total		199 (1x)

Serie 4

1:	8.2	↑
2:	6.1	↑
3:	9.1	↑
4:	9.5	↙
5:	8.0	↓
6:	8.3	→
7:	7.0	↓
8:	5.2	←
9:	7.7	↙
10:	7.6	↙
Serie		74 (0x)
Total		273 (1x)

Serie 5

1:	7.7	↙
2:	10.5x	↖
3:	8.2	→
4:	6.8	↙
5:	9.6	↙
6:	7.2	←
7:	8.2	↘
8:	6.7	↙
9:	5.0	→
10:	8.9	↖
Serie		74 (1x)
Total		347 (2x)

Serie 6

1:	9.5	↙
2:	3.7	↗
3:	4.6	↗
4:	10.1	↙
5:	8.2	↑
6:	3.7	↓
7:	8.7	↑
8:	7.9	↑
9:	8.5	←
10:	9.9	→
Serie		69 (0x)
Total		416 (2x)

Serie 6

1:	9.5	↙
2:	3.7	↗
3:	4.6	↗
4:	10.1	↙
5:	8.2	↑
6:	3.7	↓
7:	8.7	↑
8:	7.9	↑
9:	8.5	←
10:	9.9	→
Serie		69 (0x)
Total		416 (2x)

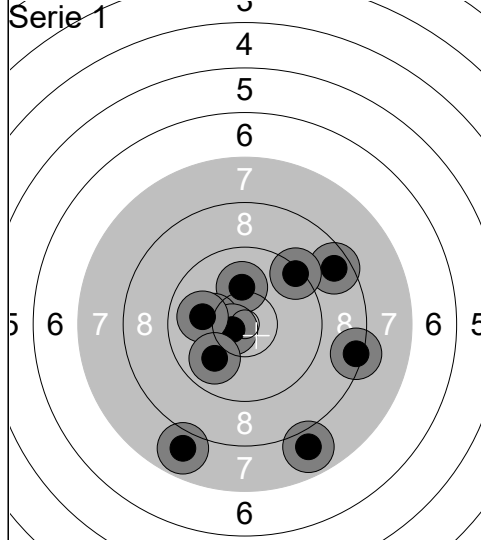

1:	10.1	↑
2:	10.2	←
3:	7.9	↘
4:	8.6	↗
5:	9.3	↗
6:	7.9	↘
7:	10.6x	←
8:	8.4	→
9:	10.0	←
10:	9.9	↘
Serie	88	(1x)
Total	88	(1x)

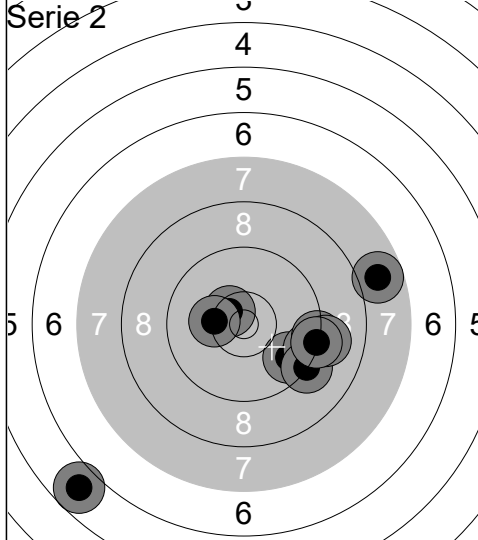

1:	9.7	↘
2:	9.4	→
3:	10.5x	↗
4:	10.3	←
5:	7.8	→
6:	9.3	→
7:	9.2	↘
8:	9.1	→
9:	9.3	→
10:	5.8	↘
Serie	86	(1x)
Total	174	(2x)

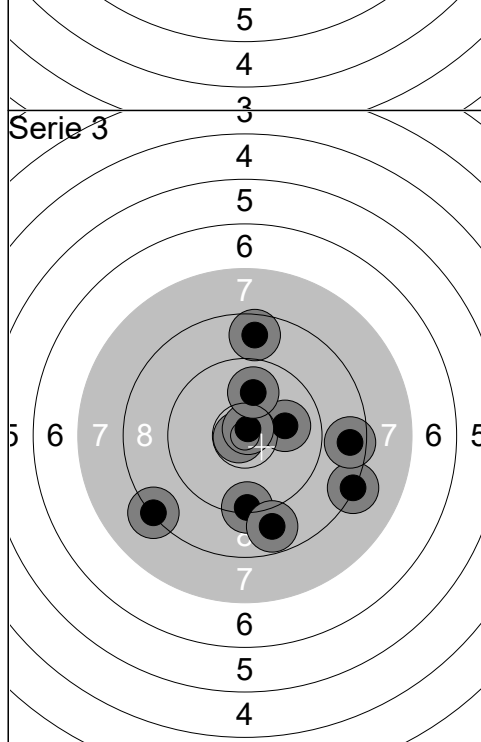

1:	8.3	↘
2:	9.3	↓
3:	10.8x	←
4:	10.0	→
5:	8.8	↘
6:	10.8x	↗
7:	10.0	↑
8:	8.3	→
9:	8.7	↑
10:	8.6	→
Serie	89	(2x)
Total	263	(4x)

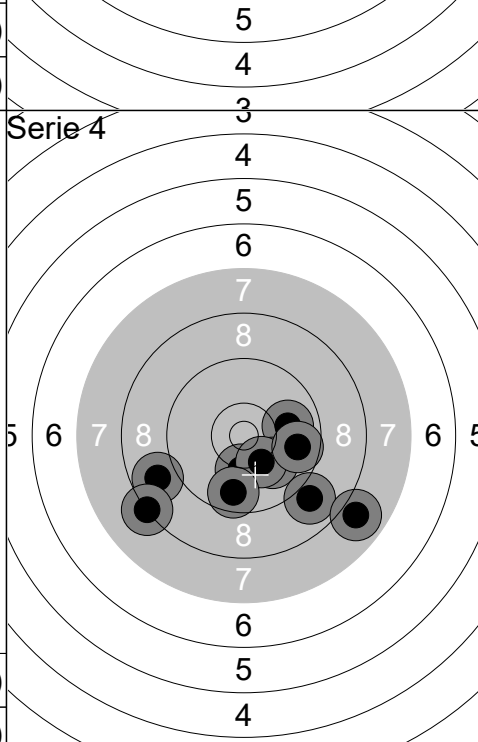

1:	9.9	→
2:	10.1	↘
3:	8.8	←
4:	10.2	↓
5:	8.9	↘
6:	10.2	↘
7:	9.7	→
8:	8.2	↘
9:	9.7	↓
10:	7.9	↘
Serie	88	(0x)
Total	351	(4x)

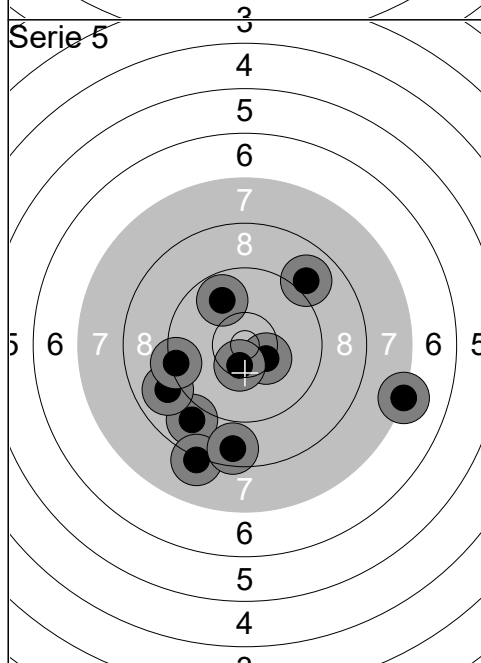

1:	8.9	↘
2:	8.2	↘
3:	10.4x	→
4:	7.2	→
5:	10.5x	↘
6:	9.0	←
7:	9.0	↗
8:	8.6	↘
9:	9.4	←
10:	9.8	↗
Serie	87	(2x)
Total	438	(6x)

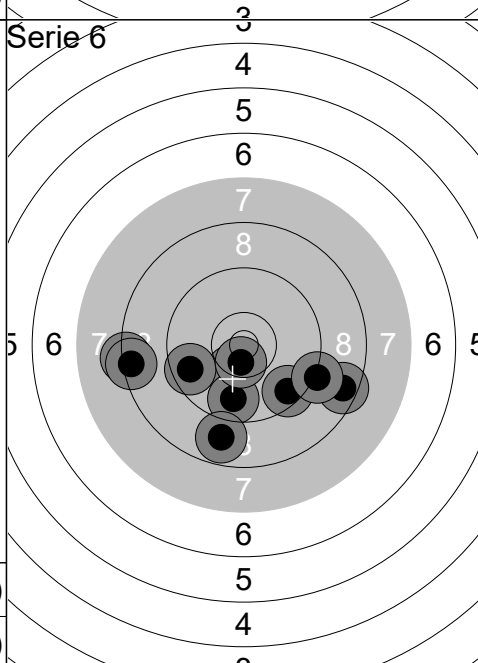

1:	9.5	↘
2:	8.3	←
3:	10.3	↘
4:	8.5	→
5:	9.7	↘
6:	9.6	←
7:	10.6x	↘
8:	9.1	→
9:	8.8	↘
10:	8.4	←
Serie	88	(1x)
Total	526	(7x)

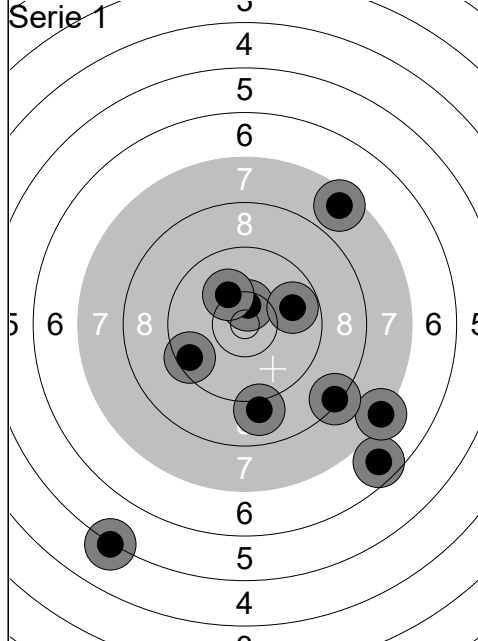

1:	10.5x ↑
2:	9.5 ↙
3:	6.6 ↘
4:	7.3 ↘
5:	9.8 →
6:	9.0 ↓
7:	10.2 ↑
8:	7.6 ↗
9:	5.2 ↓
10:	8.3 ↘
Serie	80 (1x)
Total	80 (1x)

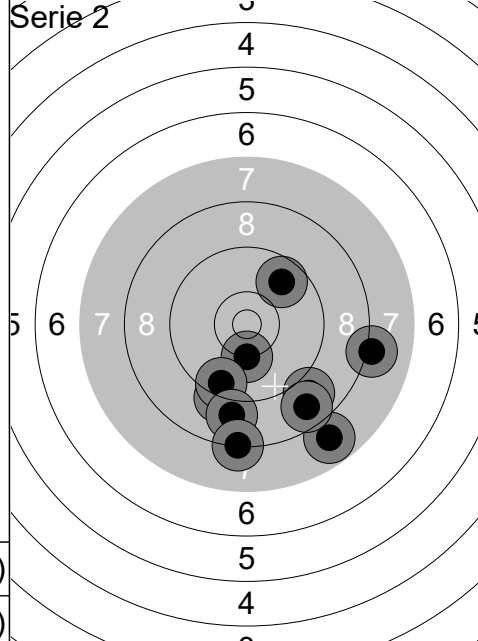

1:	9.7 ↗
2:	9.2 ↓
3:	8.9 ↘
4:	10.2 ↓
5:	9.5 ↓
6:	8.9 ↓
7:	7.8 ↘
8:	8.2 ↓
9:	8.1 →
10:	8.7 ↘
Serie	84 (0x)
Total	164 (1x)

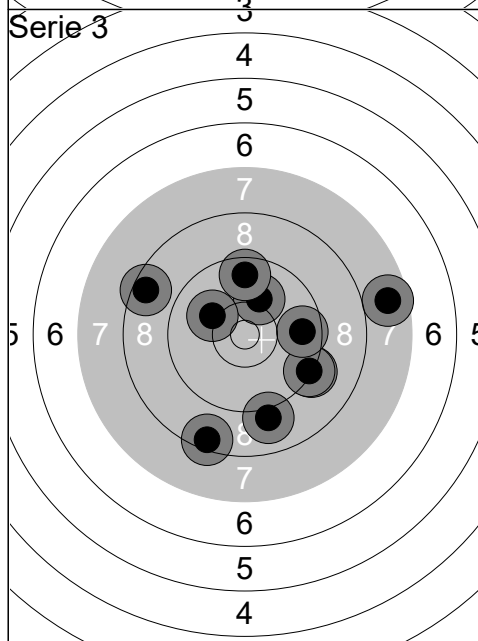

1:	10.1 ↑
2:	8.5 ↙
3:	9.2 ↘
4:	10.1 ↖
5:	8.5 ↓
6:	9.3 ↘
7:	9.7 →
8:	7.7 →
9:	9.6 ↑
10:	9.0 ↓
Serie	88 (0x)
Total	252 (1x)

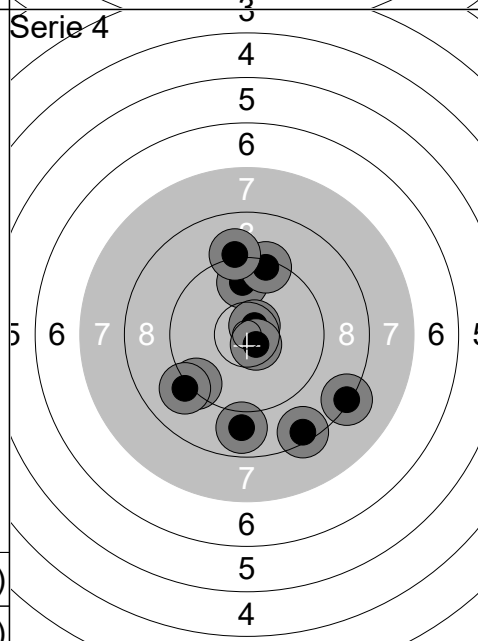

1:	9.8 ↑
2:	8.3 ↘
3:	8.4 ↘
4:	8.9 ↓
5:	9.4 ↑
6:	9.4 ↖
7:	9.1 ↑
8:	10.7x ↗
9:	10.6x ↘
10:	9.1 ↖
Serie	89 (2x)
Total	341 (3x)

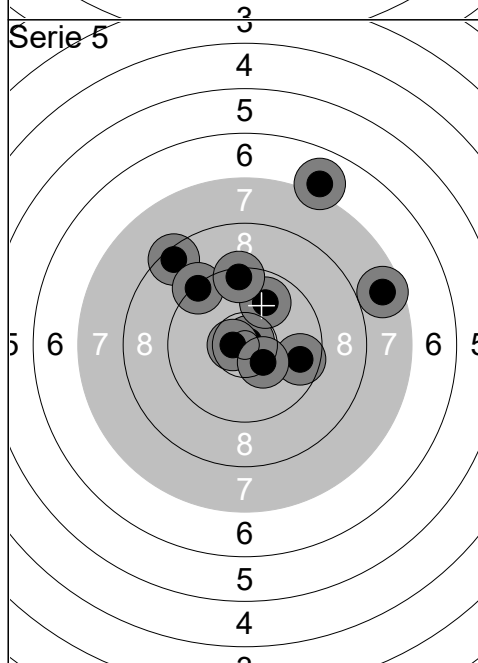

1:	7.0 ↑
2:	7.7 →
3:	10.8x ↗
4:	8.5 ↖
5:	10.7x ↖
6:	9.7 →
7:	9.3 ↗
8:	9.9 ↗
9:	10.4x ↘
10:	9.4 ↑
Serie	88 (3x)
Total	429 (6x)

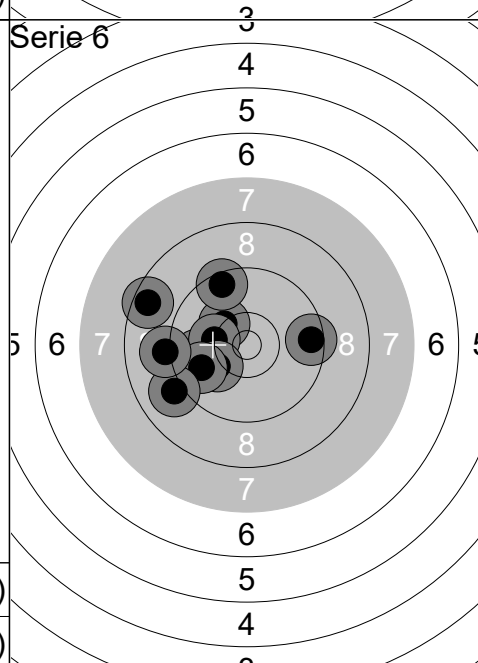

1:	9.5 →
2:	8.6 ↖
3:	10.3 ↗
4:	9.8 ↖
5:	10.2 ↖
6:	10.1 ↖
7:	9.8 ↖
8:	9.5 ↗
9:	9.0 ↖
10:	9.1 ↖
Serie	92 (0x)
Total	521 (6x)

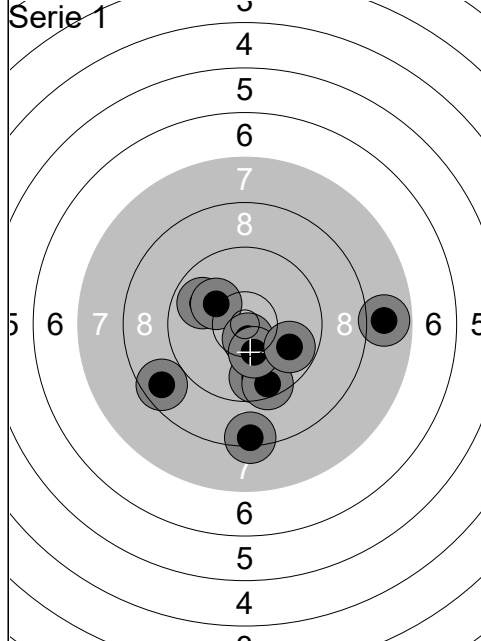

1:	7.8	→
2:	9.7	↓
3:	9.5	↓
4:	9.9	↖
5:	10.2	↖
6:	10.6x	↓
7:	8.4	↓
8:	8.7	↖
9:	10.3	↓
10:	9.8	→
Serie		89 (1x)
Total		89 (1x)

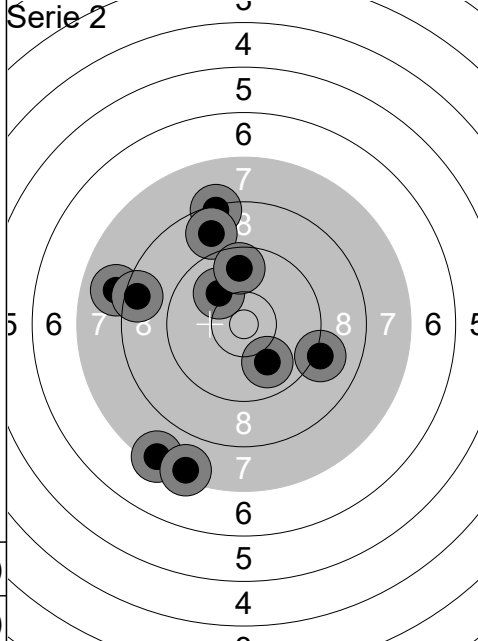

1:	10.0	↘
2:	8.0	↖
3:	8.3	↑
4:	7.4	↘
5:	8.8	↑
6:	9.1	→
7:	7.4	↘
8:	8.5	↖
9:	10.1	↖
10:	9.7	↑
Serie		84 (0x)
Total		173 (1x)

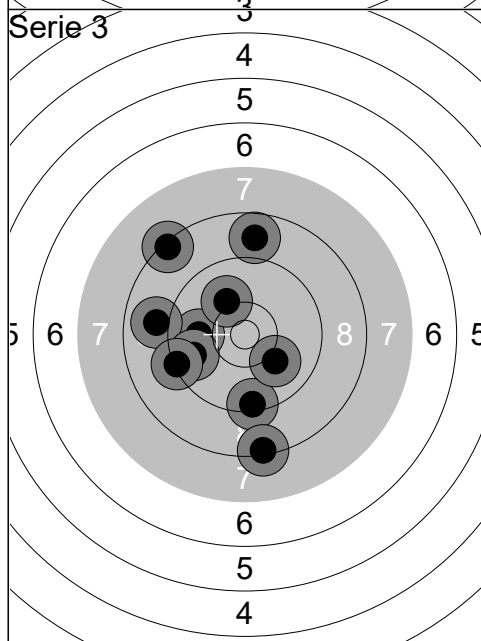

1:	8.3	↖
2:	9.4	↓
3:	9.9	↖
4:	8.9	↖
5:	8.8	↑
6:	9.7	↖
7:	9.3	↖
8:	10.0	↘
9:	8.3	↓
10:	10.1	↖
Serie		88 (0x)
Total		261 (1x)

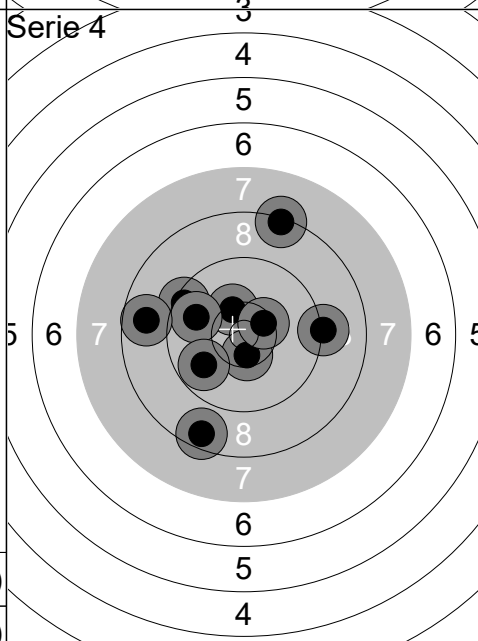

1:	10.3	↖
2:	9.4	↖
3:	9.2	→
4:	8.3	↑
5:	10.5x	↓
6:	9.8	↖
7:	10.4x	↗
8:	8.5	↓
9:	9.8	↖
10:	8.7	↖
Serie		90 (2x)
Total		351 (3x)

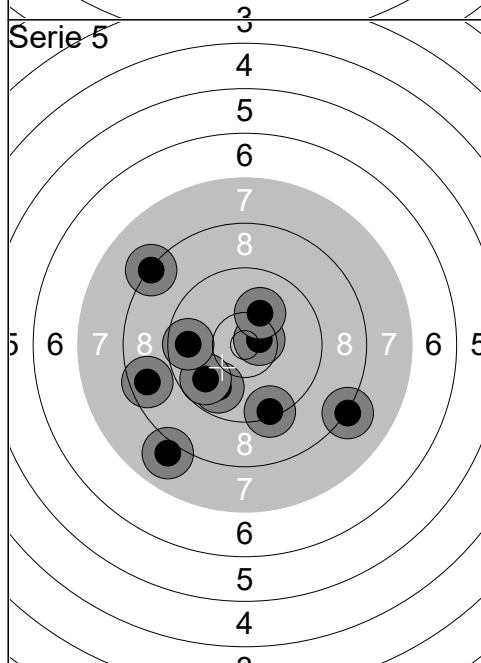

1:	9.8	↓
2:	9.8	↖
3:	8.2	↘
4:	10.6x	→
5:	10.2	↖
6:	9.4	↓
7:	8.0	↓
8:	9.7	↖
9:	8.6	↖
10:	8.3	↖
Serie		88 (1x)
Total		439 (4x)

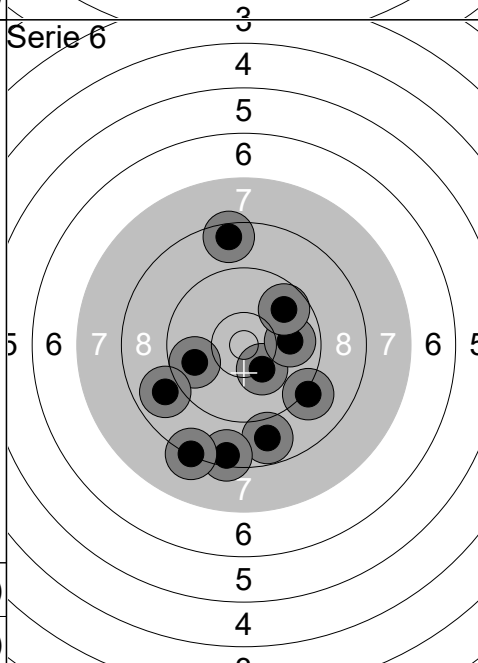

1:	10.3	↘
2:	9.1	↘
3:	8.8	↓
4:	8.5	↓
5:	8.2	↓
6:	9.9	→
7:	9.8	↖
8:	8.9	↖
9:	9.8	↖
10:	8.5	↑
Serie		86 (0x)
Total		525 (4x)

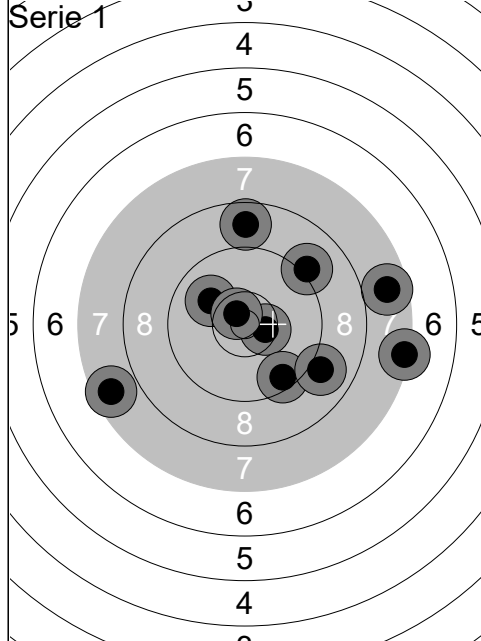

1:	10.5x	→
2:	7.3	→
3:	7.7	→
4:	9.5	↘
5:	9.0	↘
6:	8.7	↑
7:	7.6	←
8:	10.0	↖
9:	9.1	↗
10:	10.6x	↖
Serie		86 (2x)
Total		86 (2x)

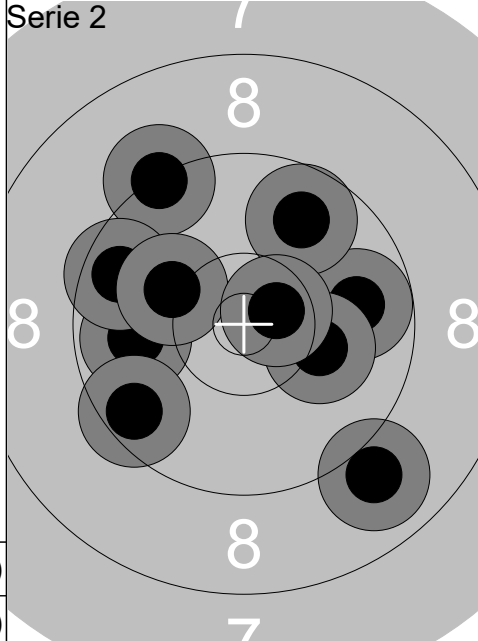

1:	9.8	→
2:	9.8	←
3:	9.3	↗
4:	9.6	↖
5:	9.5	↖
6:	10.1	↖
7:	9.8	↗
8:	10.1	→
9:	10.6x	→
10:	8.9	↘
Serie		92 (1x)
Total		178 (3x)

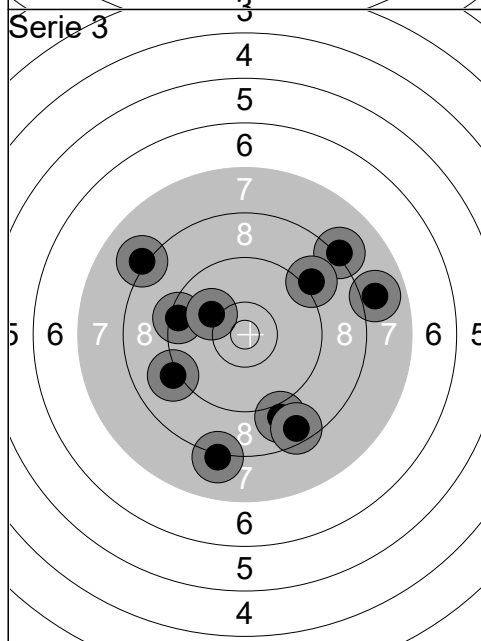

1:	8.2	↗
2:	8.9	↘
3:	9.4	←
4:	8.6	↘
5:	7.9	→
6:	9.1	←
7:	9.1	↗
8:	8.1	↘
9:	10.1	↖
10:	8.1	↖
Serie		84 (0x)
Total		262 (3x)

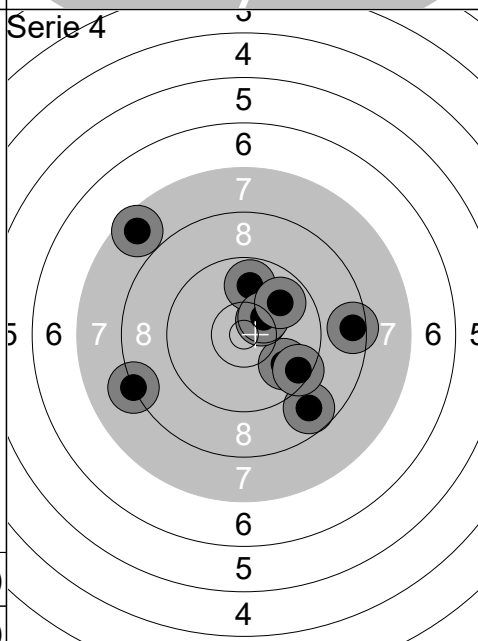

1:	9.8	↘
2:	10.4x	↗
3:	8.8	↘
4:	9.5	↘
5:	8.5	→
6:	9.8	↑
7:	8.2	←
8:	10.4x	↗
9:	9.9	↗
10:	7.6	↖
Serie		87 (2x)
Total		349 (5x)

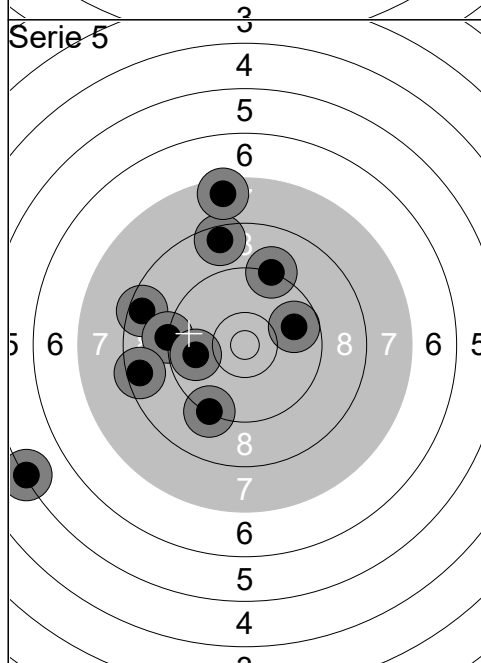

1:	8.5	↑
2:	8.5	←
3:	9.2	↗
4:	7.5	↑
5:	9.3	↘
6:	9.2	←
7:	5.3	←
8:	9.8	←
9:	9.8	→
10:	8.5	←
Serie		81 (0x)
Total		430 (5x)

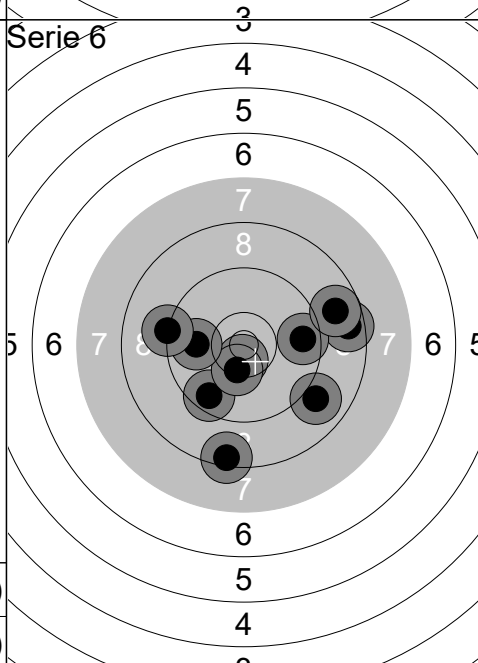

1:	10.6x	↘
2:	9.6	↘
3:	8.6	→
4:	9.6	→
5:	10.4x	↘
6:	9.9	←
7:	9.2	←
8:	8.8	→
9:	8.9	↘
10:	8.4	↘
Serie		88 (2x)
Total		518 (7x)

Serie 1

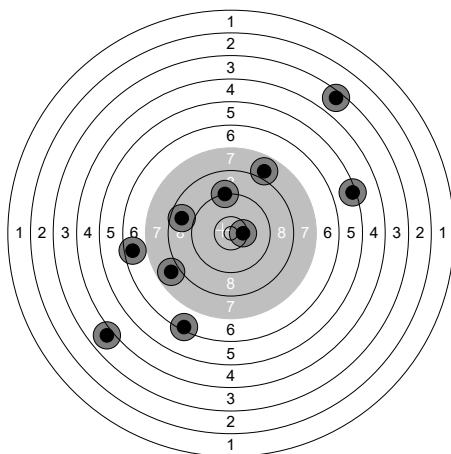

1: 6.6 ←
 2: 9.2 ↑
 3: 7.9 ↗
 4: 5.3 →
 5: 4.0 ↙
 6: 10.4x →
 7: 3.5 ↗
 8: 6.4 ↘
 9: 8.7 ←
 10: 7.9 ↙

Serie 65 (1x)

Total 65 (1x)

Serie 2

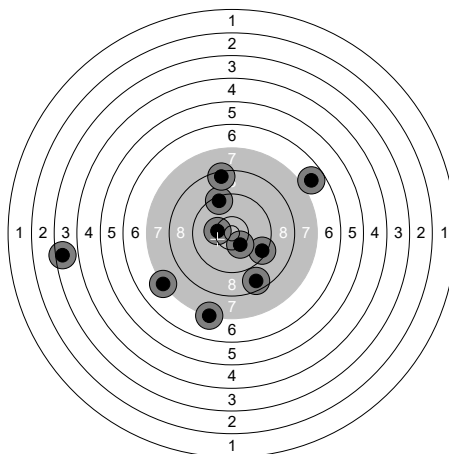

1: 8.6 ↘
 2: 6.8 ↗
 3: 9.4 ↘
 4: 9.4 ↑
 5: 7.2 ↘
 6: 8.4 ↑
 7: 3.5 ←
 8: 10.3 ↘
 9: 7.2 ↙
 10: 10.3 ←

Serie 77 (0x)

Total 142 (1x)

Serie 3

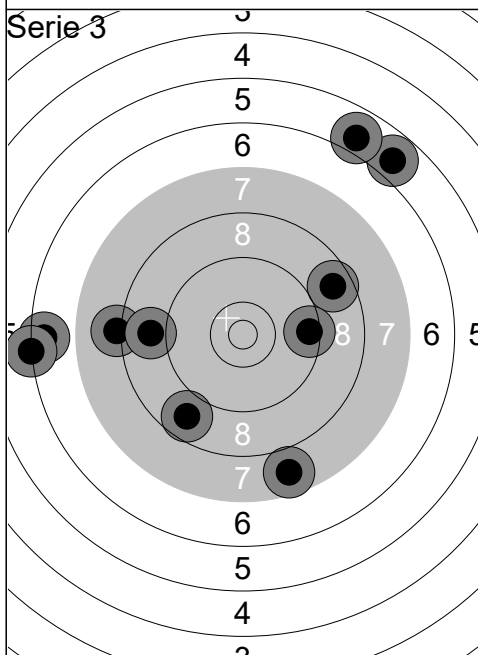

1: 8.7 ↗
 2: 8.1 ←
 3: 9.5 →
 4: 5.8 ↗
 5: 6.5 ←
 6: 7.7 ↘
 7: 6.2 ←
 8: 5.9 ↗
 9: 8.7 ↘
 10: 8.9 ←

Serie 70 (0x)

Total 212 (1x)

Serie 4

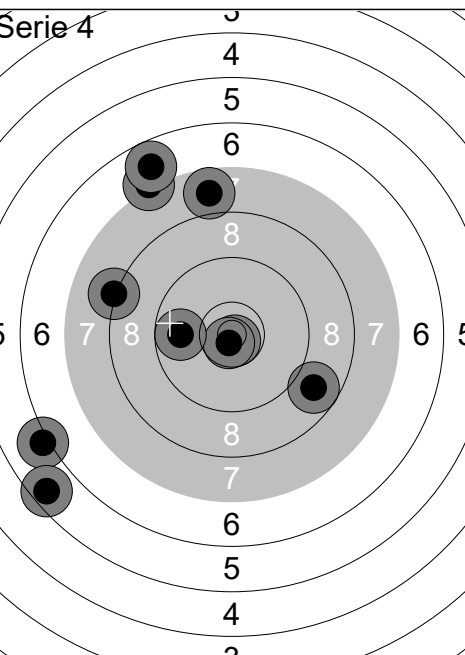

1: 6.1 ←
 2: 10.8x ↘
 3: 8.8 ↘
 4: 10.7x ↘
 5: 8.2 ←
 6: 5.5 ↙
 7: 7.1 ↗
 8: 9.8 ←
 9: 6.8 ↗
 10: 7.8 ↑

Serie 76 (2x)

Total 288 (3x)

Serie 5

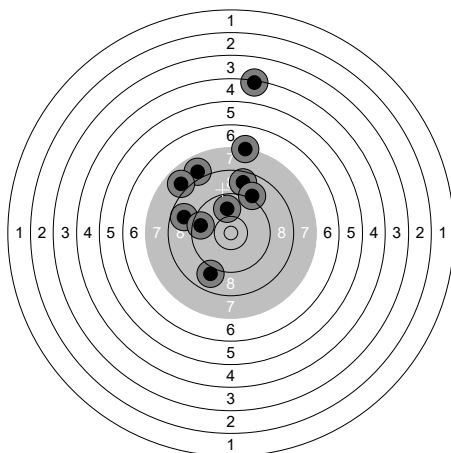

1: 7.9 ↗
 2: 7.9 ↗
 3: 8.8 ←
 4: 9.9 ↑
 5: 8.7 ↑
 6: 7.2 ↑
 7: 9.6 ←
 8: 9.1 ↗
 9: 4.3 ↑
 10: 8.9 ↘

Serie 76 (0x)

Total 364 (3x)

Serie 6

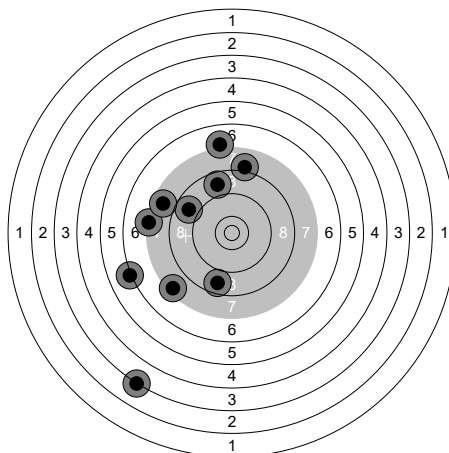

1: 7.1 ↑
 2: 8.8 ←
 3: 8.8 ↑
 4: 7.4 ↙
 5: 8.7 ↘
 6: 7.3 ←
 7: 7.7 ←
 8: 8.0 ↑
 9: 6.1 ←
 10: 3.2 ↘

Serie 69 (0x)

Total 433 (3x)

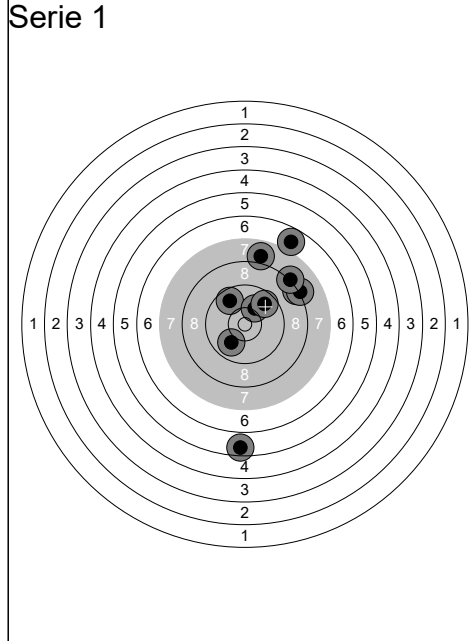

1:	9.7 ↖
2:	6.8 ↗
3:	8.3 ↗
4:	8.2 ↗
5:	10.1 ↗
6:	7.9 ↗
7:	8.2 ↗
8:	9.7 ↗
9:	5.6 ↓
10:	9.9 ↓
Serie	79 (0x)
Total	79 (0x)

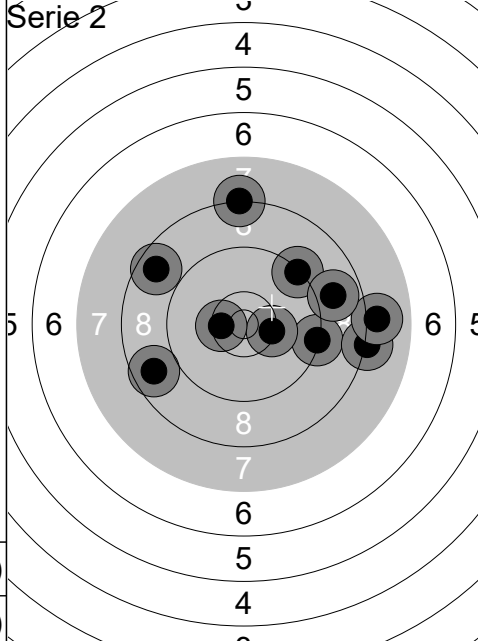

1:	9.3 →
2:	8.7 ↖
3:	9.3 ↗
4:	8.6 ↖
5:	8.2 →
6:	10.3 →
7:	8.0 →
8:	8.2 ↑
9:	10.4x ←
10:	8.9 →
Serie	86 (1x)
Total	165 (1x)

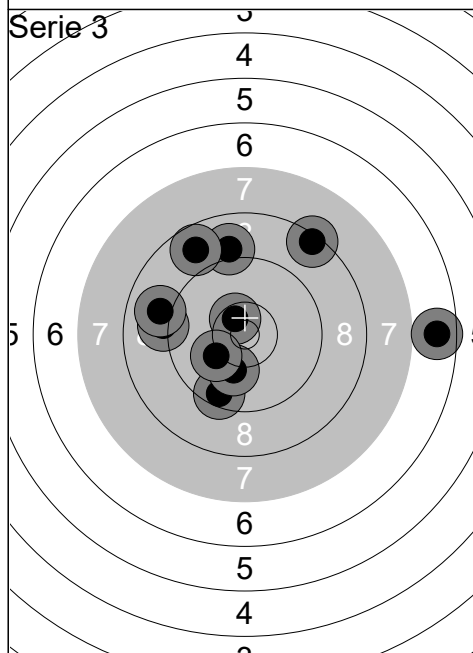

1:	6.7 →
2:	9.5 ↓
3:	8.4 ↗
4:	10.5x ↖
5:	10.1 ↓
6:	10.1 ←
7:	9.0 ↑
8:	9.1 ←
9:	8.8 ↗
10:	9.0 ←
Serie	88 (1x)
Total	253 (2x)

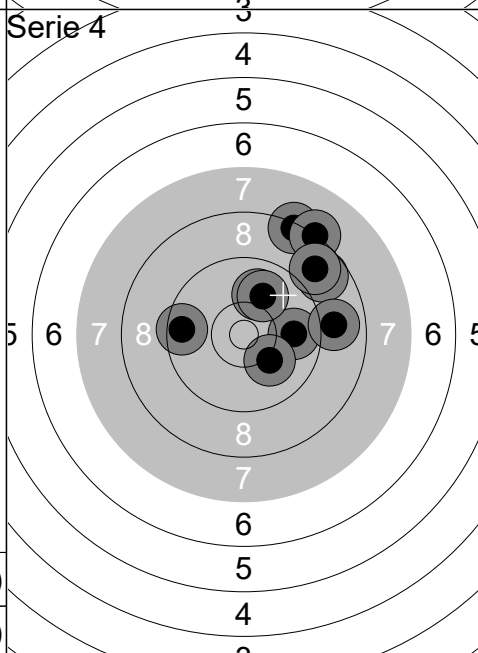

1:	10.0 ↑
2:	8.3 ↗
3:	9.6 ←
4:	9.8 →
5:	8.8 ↗
6:	8.2 ↗
7:	10.1 ↘
8:	8.9 →
9:	8.8 ↗
10:	10.0 ↗
Serie	88 (0x)
Total	341 (2x)

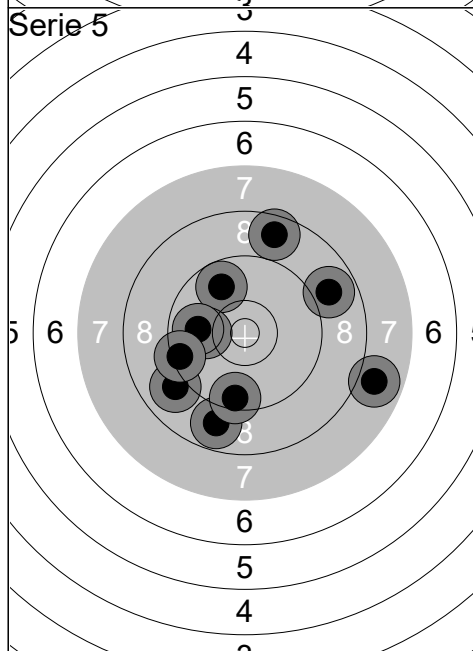

1:	8.8 ↓
2:	9.0 ↖
3:	9.8 ↗
4:	8.9 ↗
5:	10.1 ←
6:	8.7 ↗
7:	7.9 →
8:	9.5 ↓
9:	9.9 ←
10:	9.4 ←
Serie	86 (0x)
Total	427 (2x)

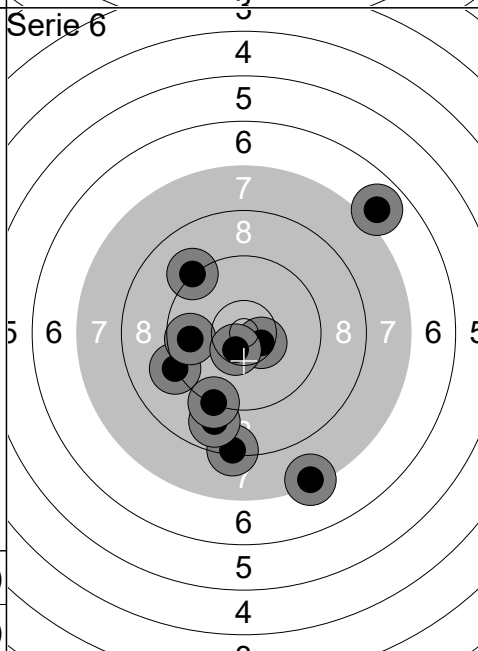

1:	6.9 ↗
2:	10.5x ↘
3:	9.2 ↖
4:	9.2 ↖
5:	8.3 ↓
6:	9.7 ←
7:	8.9 ↓
8:	9.3 ↓
9:	10.5x ↘
10:	7.4 ↓
Serie	85 (2x)
Total	512 (4x)

10 m seniorer

Umeå Pistolskytteklubb

D 1

25.03.2023

SM & JSM 10 m pistol

Umeå skytteallians

Serie 1

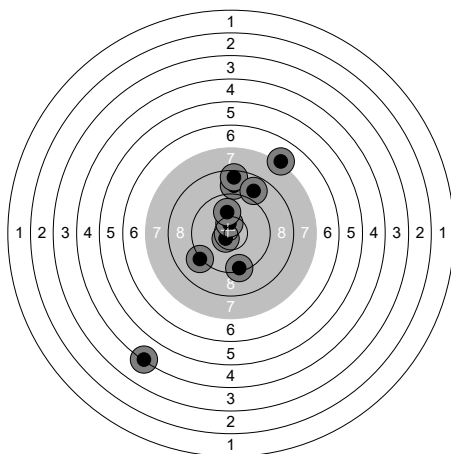

1: 9.2 ↙
 2: 8.8 ↑
 3: 10.6x ↙
 4: 10.5x ↑
 5: 10.0 ↑
 6: 8.5 ↑
 7: 4.3 ↙
 8: 7.1 ↗
 9: 9.4 ↓
 10: 8.8 ↗

Serie 83 (2x)

Total 83 (2x)

Serie 2

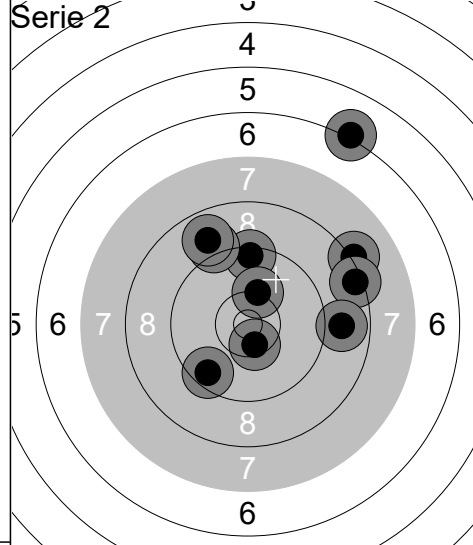

1: 9.4 ↑
 2: 10.5x ↓
 3: 9.5 ↙
 4: 8.1 ↗
 5: 9.1 ↖
 6: 10.2 ↑
 7: 8.4 ↗
 8: 8.9 →
 9: 8.9 ↖
 10: 6.2 ↗

Serie 85 (1x)

Total 168 (3x)

Serie 3

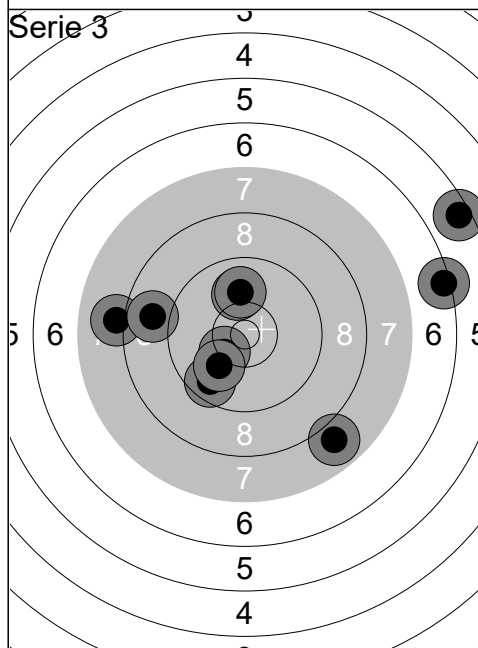

1: 7.9 ↘
 2: 8.1 ←
 3: 10.0 ↑
 4: 6.4 →
 5: 10.3 ↙
 6: 9.6 ↙
 7: 10.0 ↙
 8: 5.5 ↗
 9: 8.8 ←
 10: 10.0 ↑

Serie 83 (0x)

Total 251 (3x)

Serie 4

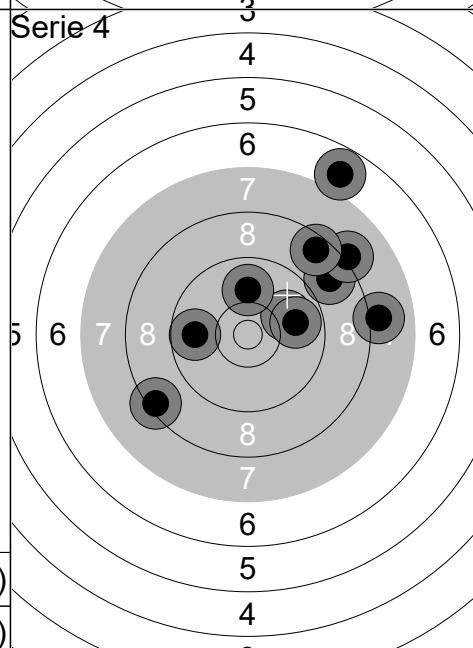

1: 8.4 ↙
 2: 8.7 ↗
 3: 8.1 ↗
 4: 9.8 ←
 5: 8.5 ↗
 6: 10.0 ↗
 7: 8.0 →
 8: 10.0 ↑
 9: 6.8 ↗
 10: 9.8 →

Serie 84 (0x)

Total 335 (3x)

Serie 5

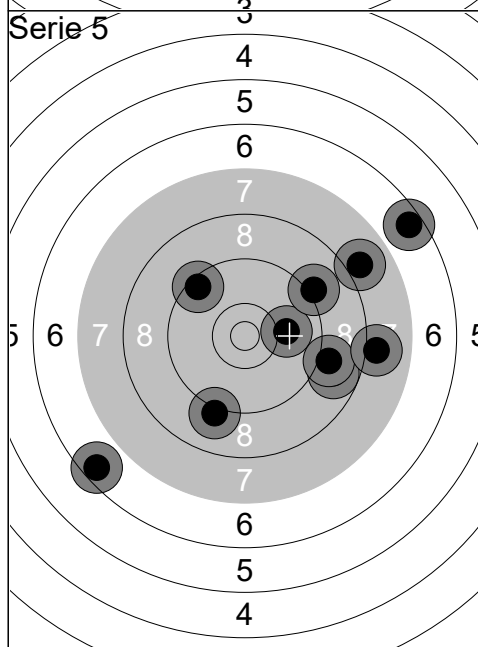

1: 8.8 →
 2: 9.1 ↓
 3: 6.5 ↙
 4: 6.5 ↗
 5: 9.4 ↖
 6: 7.9 ↗
 7: 10.0 →
 8: 9.0 →
 9: 8.0 →
 10: 9.1 ↗

Serie 81 (0x)

Total 416 (3x)

Serie 6

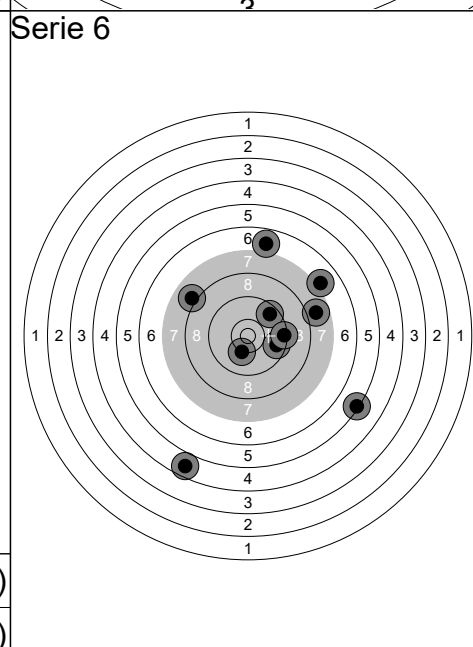

1: 7.8 →
 2: 7.0 ↗
 3: 5.3 ↘
 4: 6.9 ↑
 5: 4.7 ↓
 6: 8.0 ↖
 7: 9.6 ↗
 8: 10.2 ↓
 9: 9.6 →
 10: 9.4 →

Serie 74 (0x)

Total 490 (3x)

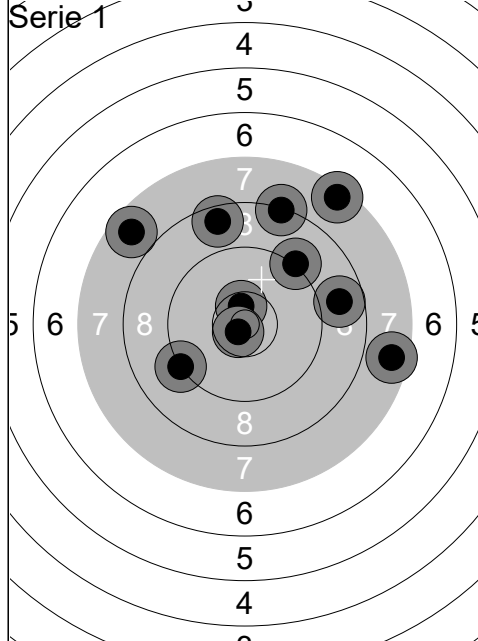

1:	10.5x	↑
2:	8.3	↑
3:	9.2	←
4:	7.6	→
5:	8.6	↑
6:	8.8	→
7:	7.7	↖
8:	10.7x	↙
9:	9.2	↗
10:	7.4	↗
Serie		83 (2x)
Total		83 (2x)

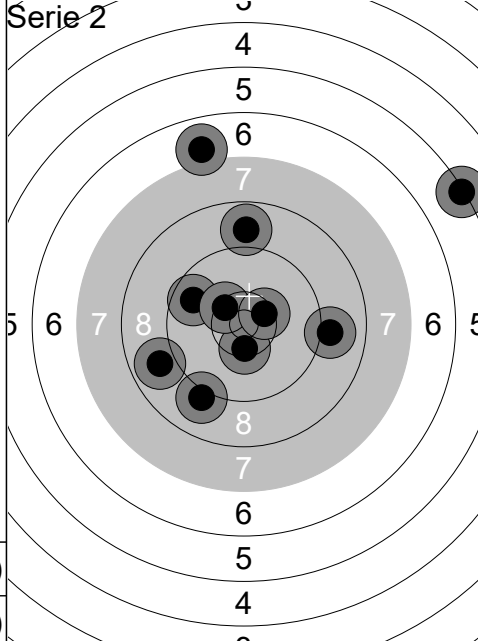

1:	10.4x	↓
2:	5.3	↗
3:	9.7	↖
4:	6.9	↑
5:	9.1	↓
6:	9.0	→
7:	10.4x	↖
8:	10.4x	↗
9:	8.8	↑
10:	8.9	↖
Serie		84 (3x)
Total		167 (5x)

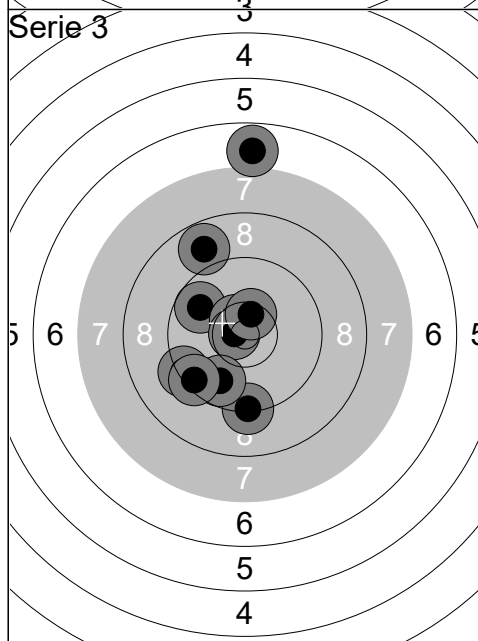

1:	6.9	↑
2:	9.3	↖
3:	9.8	↖
4:	10.6x	↖
5:	9.3	↓
6:	10.7x	↖
7:	10.5x	↑
8:	8.8	↑
9:	9.8	↓
10:	9.4	↖
Serie		89 (3x)
Total		256 (8x)

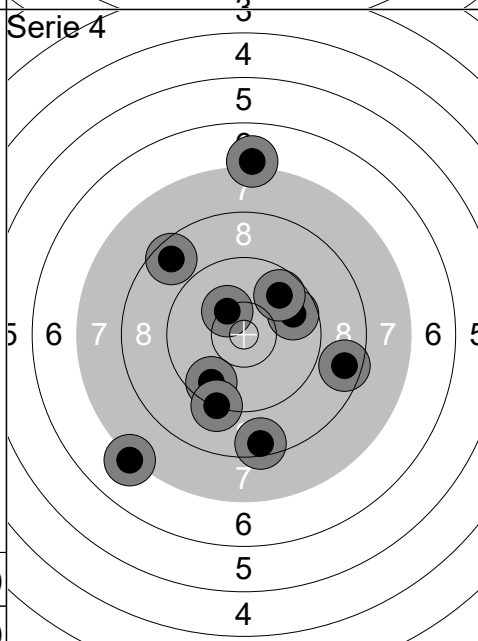

1:	9.8	↗
2:	8.5	↓
3:	7.2	↖
4:	9.7	↖
5:	7.1	↑
6:	9.8	↗
7:	10.3	↖
8:	9.2	↓
9:	8.6	→
10:	8.6	↖
Serie		84 (0x)
Total		340 (8x)

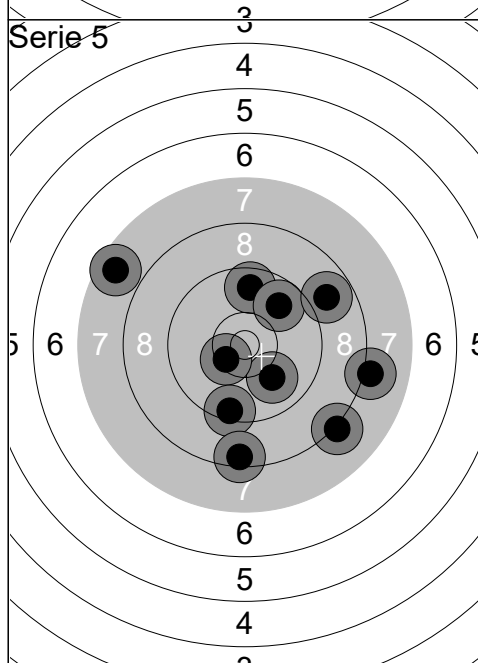

1:	10.0	↓
2:	10.4x	↖
3:	8.1	→
4:	9.6	↑
5:	7.6	↖
6:	9.8	↗
7:	8.8	↗
8:	8.2	↘
9:	9.4	↓
10:	8.4	↓
Serie		86 (1x)
Total		426 (9x)

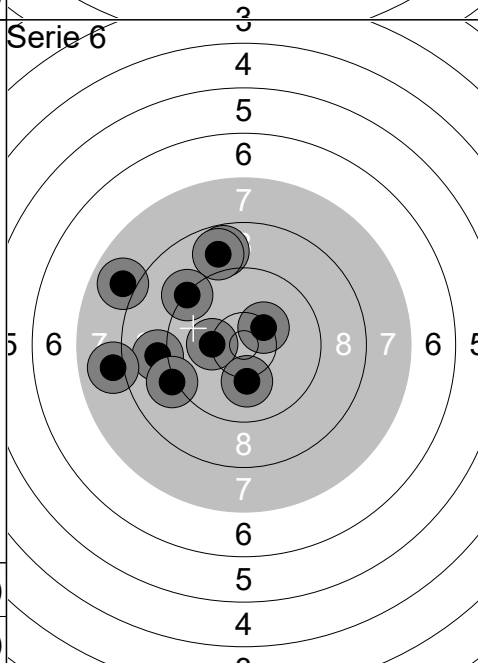

1:	9.0	←
2:	8.0	←
3:	9.1	↖
4:	8.8	↑
5:	10.2	←
6:	10.4x	↗
7:	8.8	↑
8:	7.9	↖
9:	9.3	↖
10:	10.1	↓
Serie		88 (1x)
Total		514 (10x)

10 m seniorer

Umeå Pistolskytteklubb

H 1

25.03.2023

SM & JSM 10 m pistol

Umeå skytteallians

Serie 1

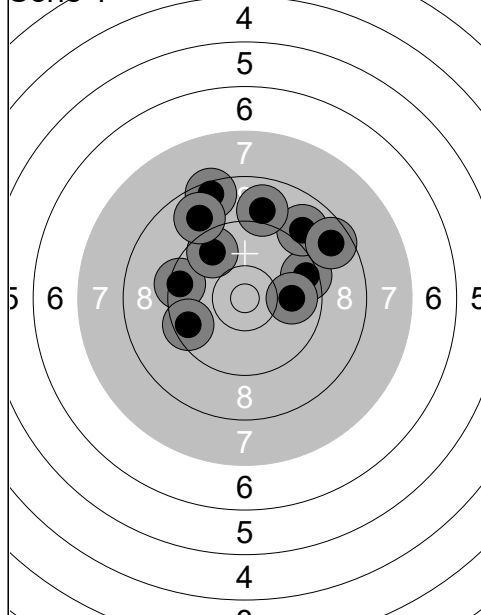

1: 9.5 →
 2: 8.5 ↑
 3: 9.0 ↗
 4: 9.5 ←
 5: 9.9 →
 6: 9.7 ↗
 7: 8.7 ↗
 8: 8.9 ↑
 9: 9.6 ←
 10: 9.0 ↑

Serie 87 (0x)
 Total 87 (0x)

Serie 2

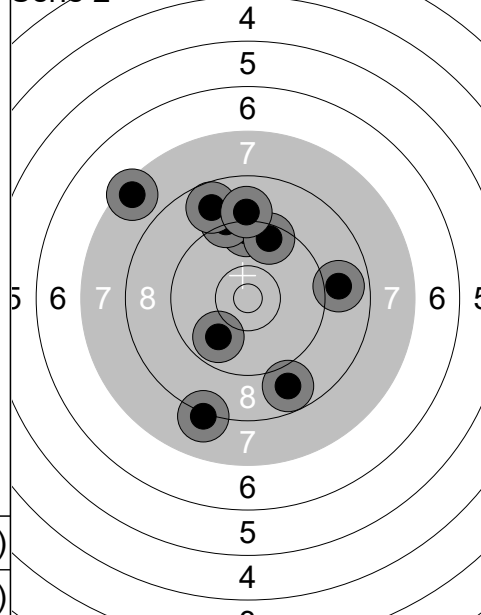

1: 9.4 ↑
 2: 7.5 ↖
 3: 8.8 ↓
 4: 9.2 ↑
 5: 9.5 ↑
 6: 8.8 ↑
 7: 9.0 ↑
 8: 8.1 ↓
 9: 9.9 ↓
 10: 8.9 →

Serie 84 (0x)
 Total 171 (0x)

Serie 3

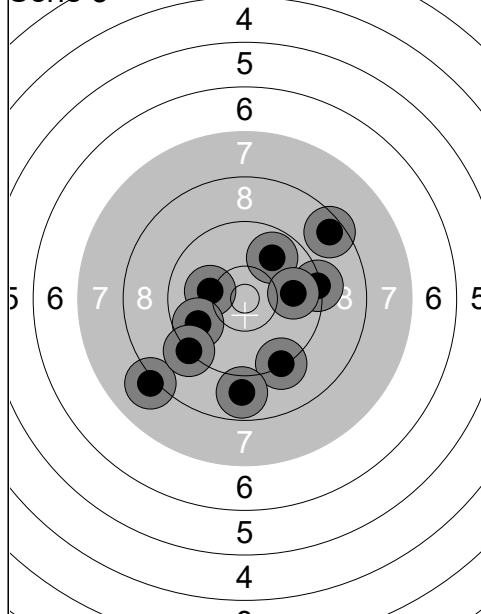

1: 10.1 ←
 2: 8.1 ↖
 3: 9.8 ←
 4: 9.8 ↗
 5: 9.3 →
 6: 9.3 ↓
 7: 8.9 ↓
 8: 9.2 ↖
 9: 9.9 →
 10: 8.5 ↗

Serie 88 (0x)
 Total 259 (0x)

Serie 4

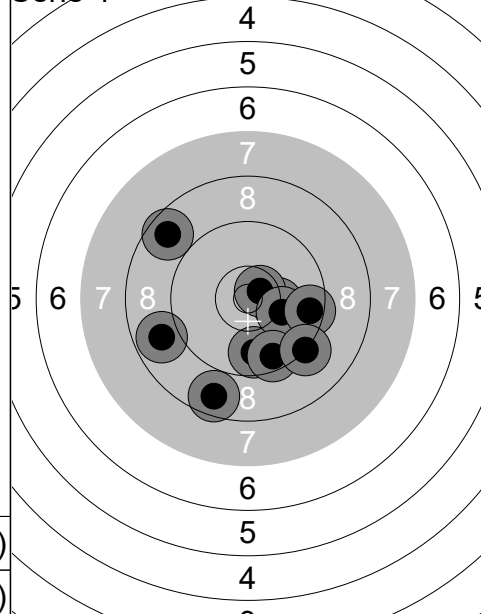

1: 8.9 ←
 2: 10.3 →
 3: 10.6x ↗
 4: 9.8 ↓
 5: 10.1 →
 6: 9.6 ↓
 7: 9.5 →
 8: 8.7 ↗
 9: 9.2 ↓
 10: 8.6 ↓

Serie 90 (1x)
 Total 349 (1x)

Serie 5

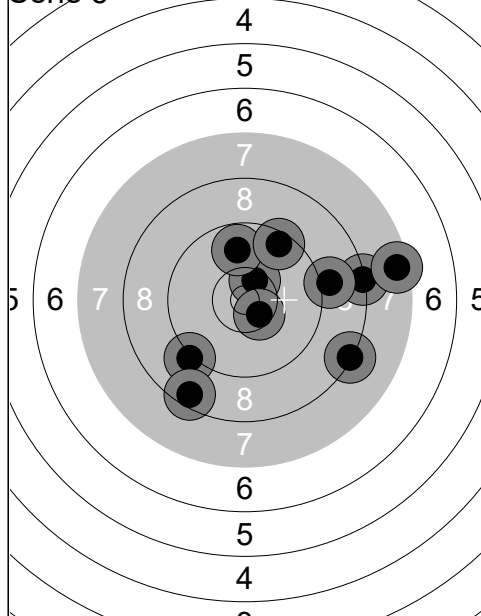

1: 8.3 →
 2: 10.5x ↗
 3: 8.3 ↘
 4: 7.5 →
 5: 9.8 ↑
 6: 9.5 ↗
 7: 9.0 →
 8: 9.2 ↖
 9: 8.5 ↓
 10: 10.5x ↘

Serie 87 (2x)
 Total 436 (3x)

Serie 6

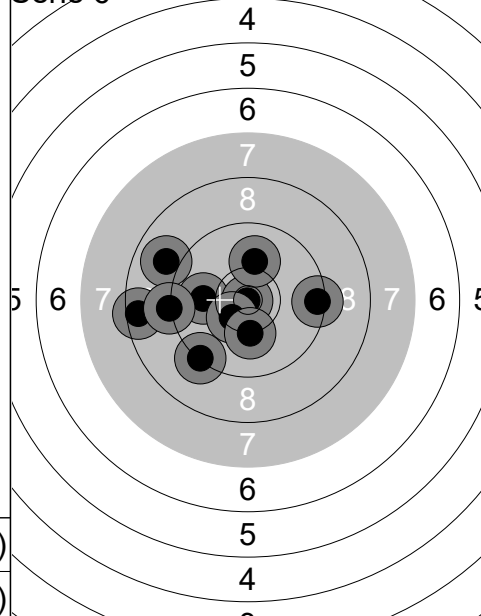

1: 9.9 ←
 2: 10.9x ↖
 3: 8.5 ←
 4: 9.4 →
 5: 10.4x ↖
 6: 8.9 ←
 7: 10.1 ↑
 8: 9.3 ↖
 9: 10.2 ↓
 10: 9.2 ←

Serie 92 (2x)
 Total 528 (5x)

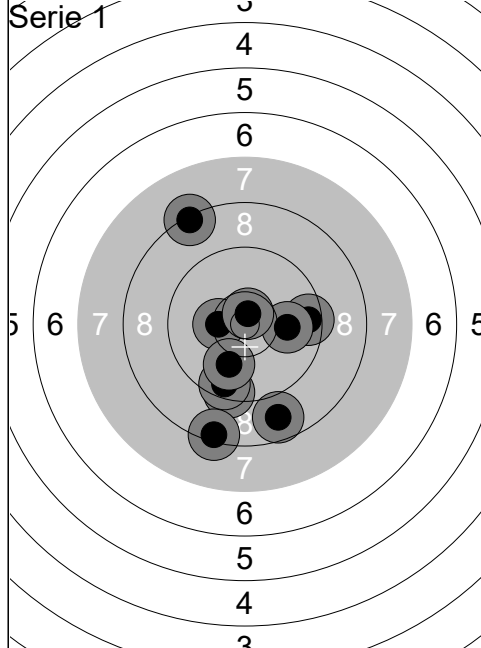

1:	10.4	←
2:	9.4	↓
3:	8.7	↓
4:	9.5	↓
5:	9.5	→
6:	10.0	↓
7:	8.3	↑
8:	8.4	↓
9:	10.0	→
10:	10.7x	↑
Serie		91 (1x)
Total		91 (1x)

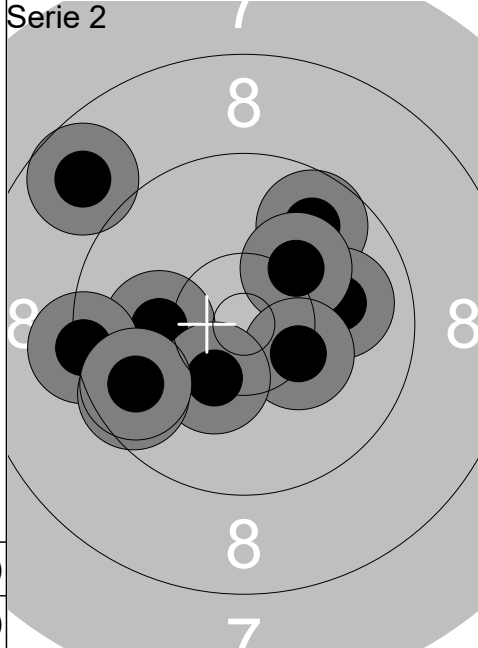

1:	10.1	←
2:	9.7	↗
3:	9.3	←
4:	10.0	→
5:	8.8	↖
6:	10.2	↗
7:	10.3	↘
8:	10.3	↓
9:	9.6	↖
10:	9.7	↖
Serie		94 (0x)
Total		185 (1x)

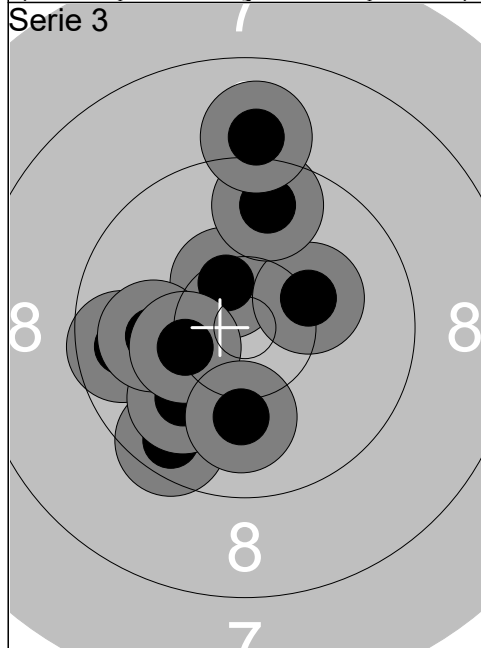

1:	9.7	←
2:	9.6	↓
3:	10.0	↖
4:	10.5x	↖
5:	10.0	←
6:	10.2	→
7:	9.7	↑
8:	10.3	←
9:	10.0	↓
10:	9.0	↑
Serie		96 (1x)
Total		281 (2x)

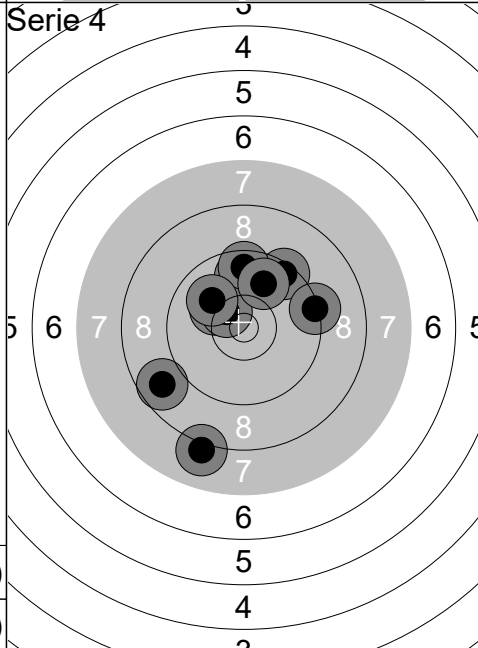

1:	10.2	↖
2:	9.4	↗
3:	9.8	↑
4:	9.3	→
5:	9.6	↑
6:	10.4x	↖
7:	10.0	↖
8:	9.9	↑
9:	8.1	↓
10:	8.7	↖
Serie		91 (1x)
Total		372 (3x)

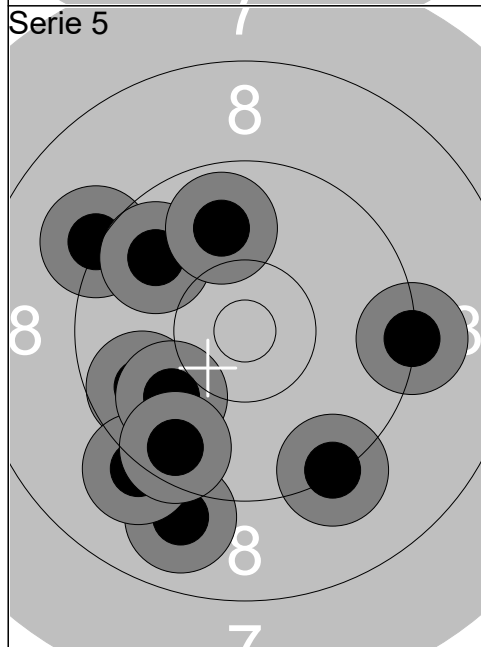

1:	9.8	↖
2:	9.0	↓
3:	9.2	↖
4:	9.3	↓
5:	9.2	↓
6:	9.9	↖
7:	9.6	↓
8:	9.3	→
9:	9.8	↖
10:	9.9	↑
Serie		90 (0x)
Total		462 (3x)

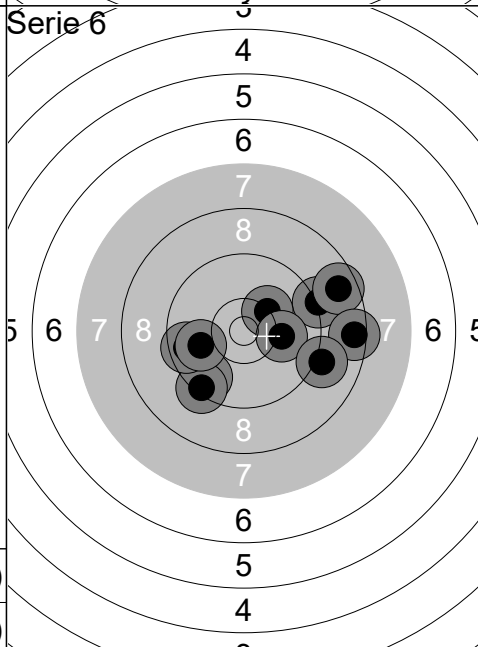

1:	9.6	↖
2:	9.2	→
3:	9.4	↖
4:	9.6	←
5:	8.6	→
6:	10.3	↗
7:	8.5	→
8:	10.1	→
9:	9.1	↘
10:	9.9	←
Serie		90 (0x)
Total		552 (3x)

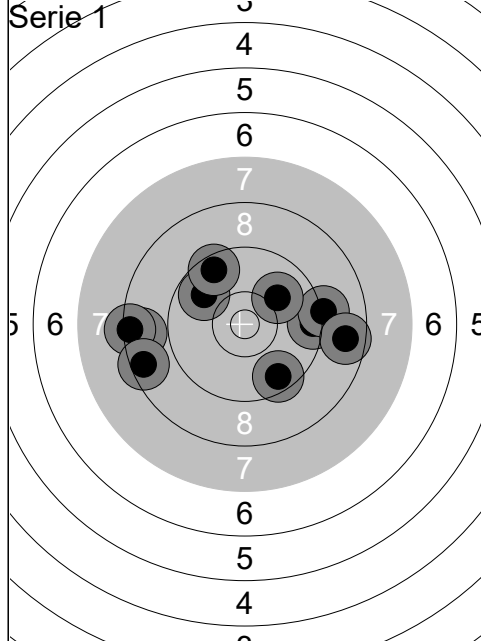

1:	9.4	→
2:	8.6	←
3:	9.2	→
4:	8.4	←
5:	8.5	←
6:	9.8	↖
7:	8.7	→
8:	9.5	↗
9:	9.6	↘
10:	10.0	↗
Serie		87 (0x)
Total		87 (0x)

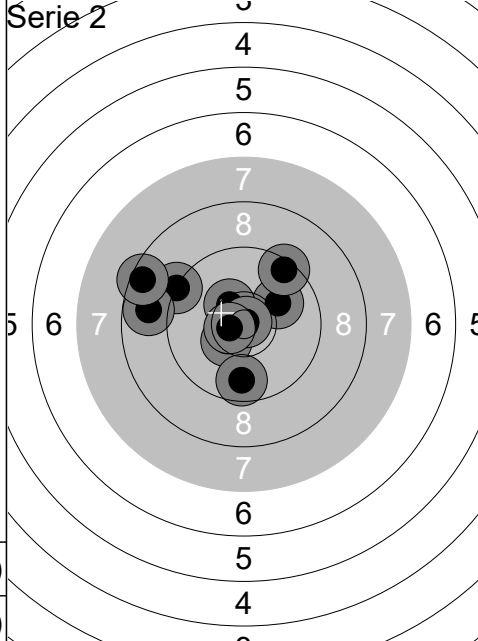

1:	9.2	↖
2:	10.0	↗
3:	10.4x	↙
4:	9.4	↗
5:	10.4x	↖
6:	10.9x	↗
7:	10.6x	←
8:	8.8	←
9:	8.5	↖
10:	9.7	↓
Serie		93 (4x)
Total		180 (4x)

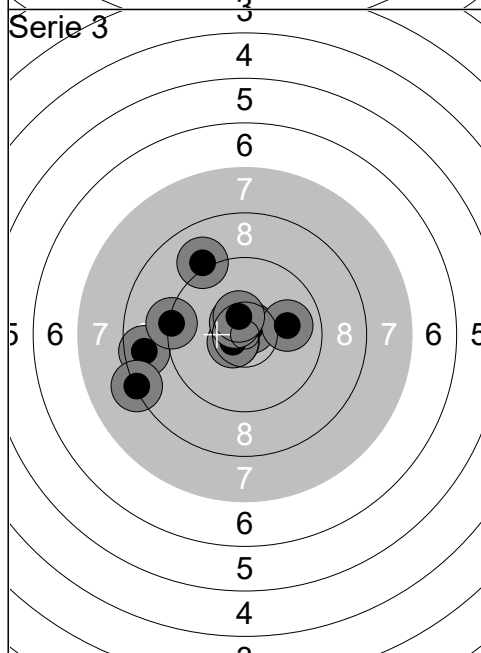

1:	8.7	←
2:	10.7x	↗
3:	10.0	→
4:	10.6x	↙
5:	10.6x	↙
6:	10.6x	↖
7:	9.1	↗
8:	8.3	←
9:	9.3	←
10:	10.5x	↗
Serie		94 (5x)
Total		274 (9x)

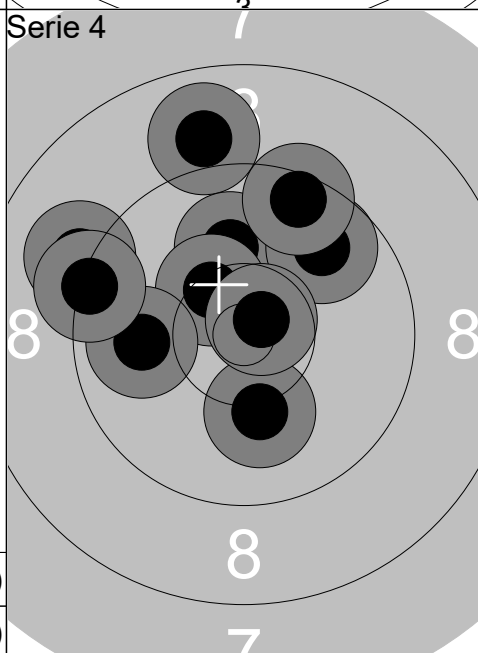

1:	8.9	↑
2:	10.1	↓
3:	10.1	↑
4:	9.8	↗
5:	9.1	↖
6:	10.4x	↖
7:	9.9	←
8:	9.5	↗
9:	9.3	←
10:	10.7x	↗
Serie		93 (2x)
Total		367 (11x)

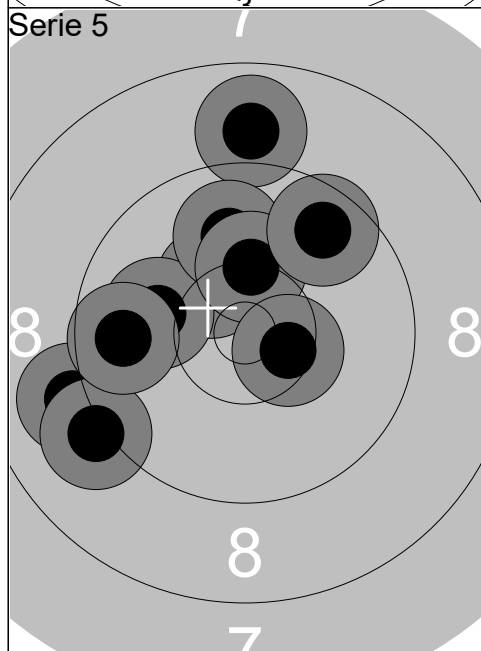

1:	8.9	↑
2:	9.1	←
3:	10.3	↖
4:	10.0	←
5:	9.9	↑
6:	10.3	↑
7:	10.5x	→
8:	9.6	↗
9:	9.1	←
10:	9.7	←
Serie		93 (1x)
Total		460 (12x)

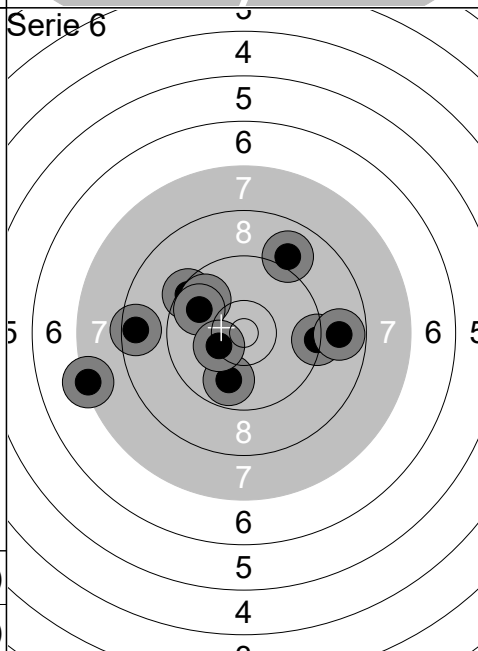

1:	9.4	↖
2:	9.8	↖
3:	7.3	←
4:	9.3	→
5:	8.5	←
6:	8.8	→
7:	9.8	↓
8:	9.0	↗
9:	9.8	↖
10:	10.3	←
Serie		87 (0x)
Total		547 (12x)

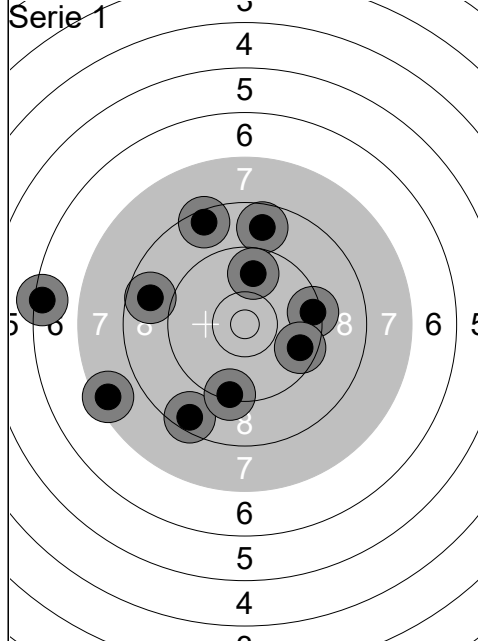

1:	8.8	←
2:	9.4	→
3:	8.5	↙
4:	9.3	↘
5:	6.4	←
6:	8.8	↑
7:	8.5	↑
8:	7.5	←
9:	9.6	→
10:	9.8	↑
Serie	81 (0x)	
Total	81 (0x)	

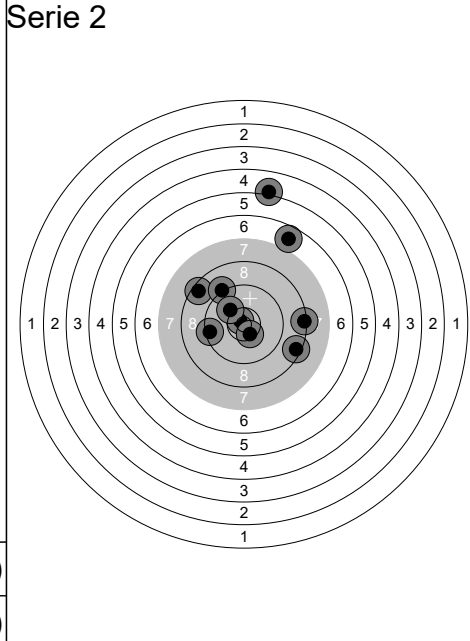

1:	8.4	→
2:	8.5	↖
3:	10.7x	↗
4:	9.2	↗
5:	5.1	↑
6:	10.1	↗
7:	9.4	←
8:	8.3	→
9:	6.7	↗
10:	10.4x	↘
Serie	83 (2x)	
Total	164 (2x)	

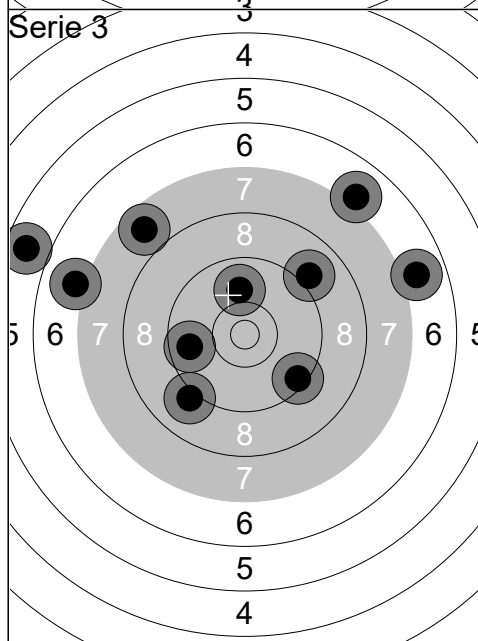

1:	9.0	↗
2:	7.0	←
3:	9.4	↘
4:	5.7	←
5:	6.9	→
6:	9.7	←
7:	7.7	↗
8:	10.0	↑
9:	9.1	↘
10:	7.0	↗
Serie	78 (0x)	
Total	242 (2x)	

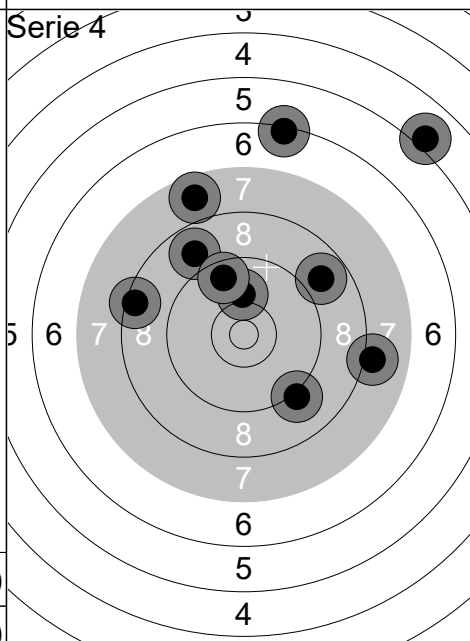

1:	8.4	←
2:	8.8	↗
3:	8.8	↖
4:	5.0	↗
5:	10.1	↑
6:	9.6	↑
7:	9.1	↘
8:	6.3	↑
9:	7.7	↑
10:	8.0	→
Serie	78 (0x)	
Total	320 (2x)	

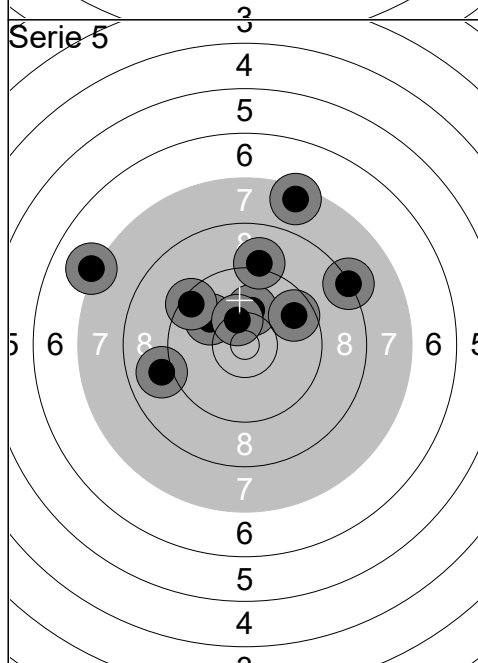

1:	10.0	↖
2:	10.2	↑
3:	9.0	←
4:	7.1	←
5:	9.1	↑
6:	9.4	↖
7:	7.5	↑
8:	9.7	↗
9:	10.4x	↖
10:	8.3	↗
Serie	88 (1x)	
Total	408 (3x)	

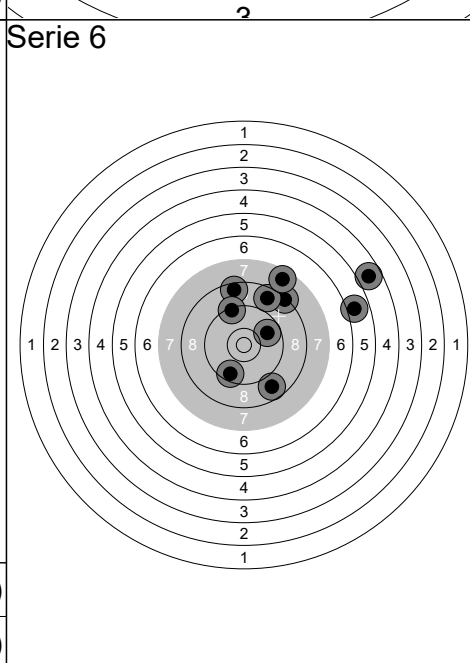

1:	8.3	↗
2:	4.8	↗
3:	8.8	↘
4:	8.7	↗
5:	5.9	→
6:	9.6	↘
7:	7.6	↗
8:	9.8	↗
9:	8.5	↑
10:	9.3	↑
Serie	75 (0x)	
Total	483 (3x)	

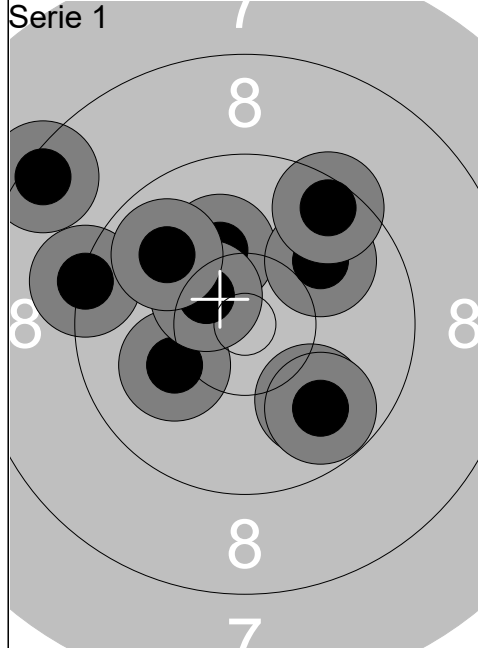

1:	10.2	↑
2:	9.9	↘
3:	9.9	↗
4:	9.8	↘
5:	10.1	↙
6:	9.3	←
7:	8.4	↖
8:	9.5	↗
9:	10.5x	↖
10:	9.9	↖
Serie		92 (1x)
Total		92 (1x)

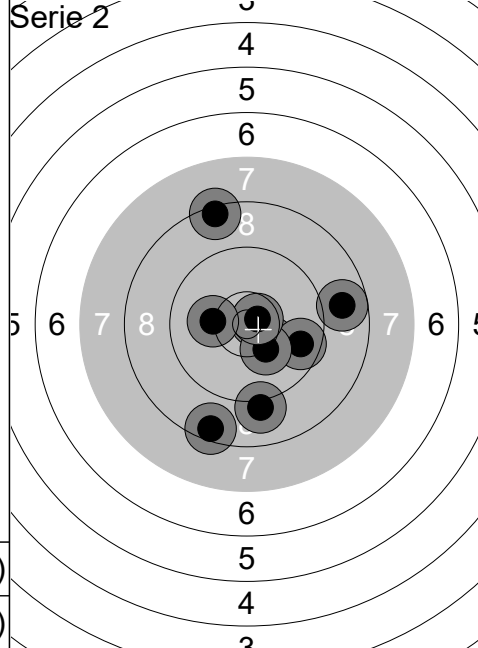

1:	8.5	↘
2:	8.4	↑
3:	10.7x	→
4:	9.1	↘
5:	10.3	↘
6:	9.7	→
7:	10.2	↘
8:	8.8	→
9:	10.7x	↗
10:	10.2	←
Serie		92 (2x)
Total		184 (3x)

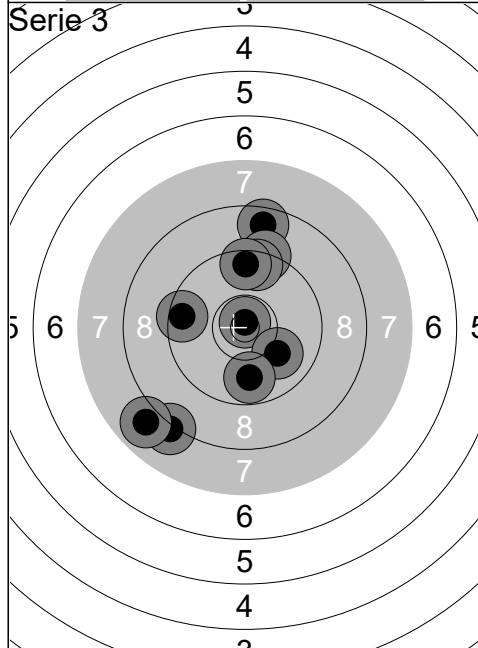

1:	10.8x	↑
2:	8.1	↘
3:	7.9	↙
4:	8.6	↑
5:	10.0	↘
6:	9.3	↑
7:	9.5	←
8:	9.5	↑
9:	9.5	↑
10:	9.8	↓
Serie		88 (1x)
Total		272 (4x)

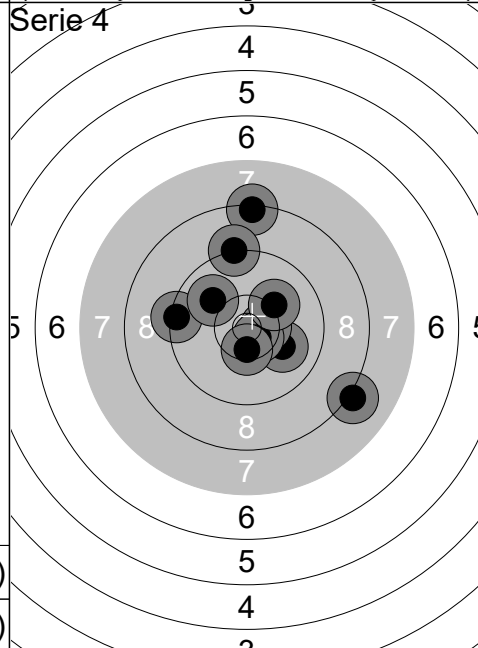

1:	9.4	←
2:	10.1	↘
3:	10.5x	→
4:	10.6x	↘
5:	10.0	↖
6:	8.3	↑
7:	9.2	↑
8:	10.5x	↓
9:	8.1	↘
10:	10.1	↗
Serie		94 (3x)
Total		366 (7x)

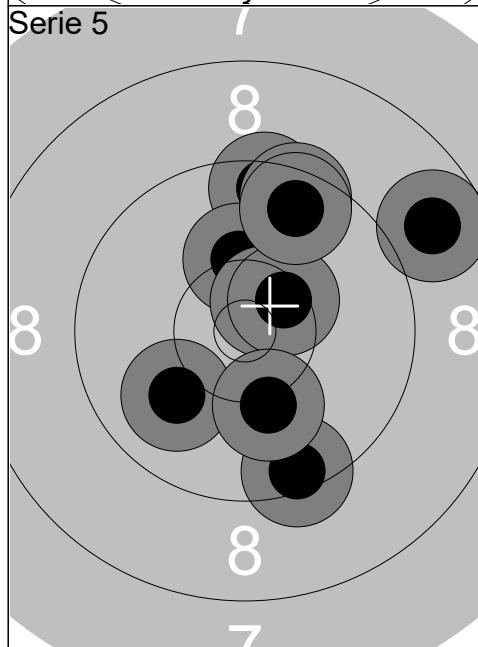

1:	9.5	↑
2:	10.0	↙
3:	8.8	↗
4:	10.2	↑
5:	10.6x	↗
6:	9.5	↑
7:	10.4x	↗
8:	9.4	↘
9:	10.2	↘
10:	9.6	↑
Serie		94 (2x)
Total		460 (9x)

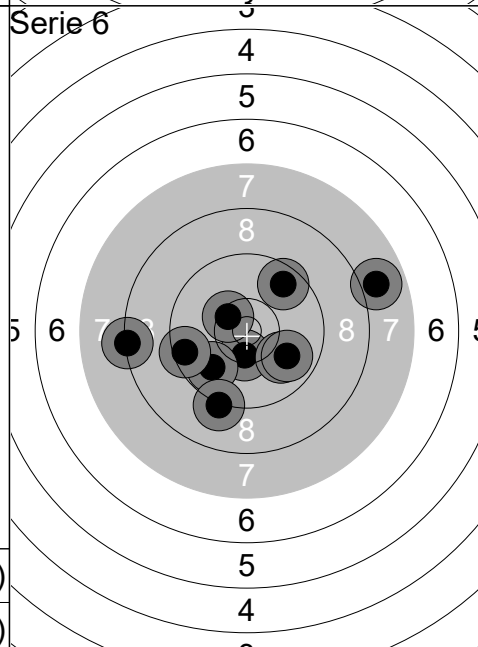

1:	10.4x	↓
2:	9.8	↙
3:	9.6	↗
4:	10.0	↘
5:	7.9	→
6:	8.3	←
7:	10.4x	↖
8:	9.9	↘
9:	9.5	←
10:	9.2	↓
Serie		90 (2x)
Total		550 (11x)

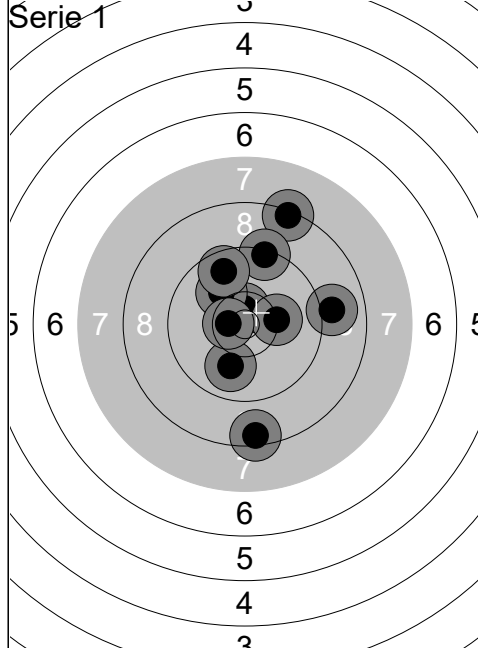

1:	10.0	↓
2:	10.6x	↑
3:	8.3	↗
4:	9.3	↑
5:	8.5	↓
6:	10.2	→
7:	10.1	↖
8:	10.6x	←
9:	9.7	↑
10:	9.0	→
Serie		93 (2x)
Total		93 (2x)

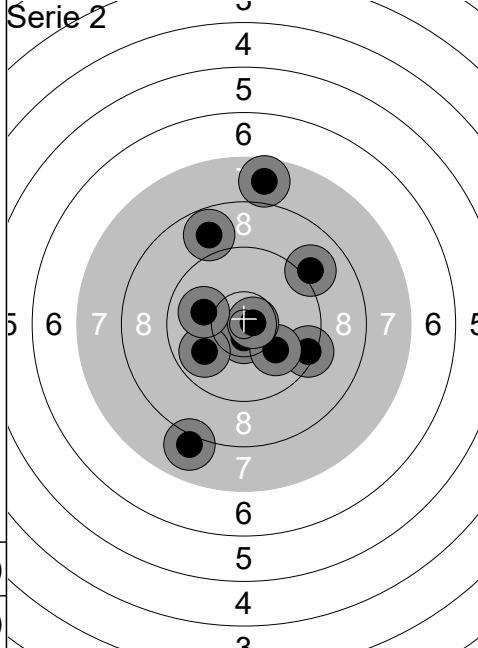

1:	8.8	↖
2:	7.7	↑
3:	9.4	→
4:	10.6x	↓
5:	8.0	↓
6:	9.0	↗
7:	10.0	↘
8:	10.7x	→
9:	9.9	↙
10:	10.0	←
Serie		90 (2x)
Total		183 (4x)

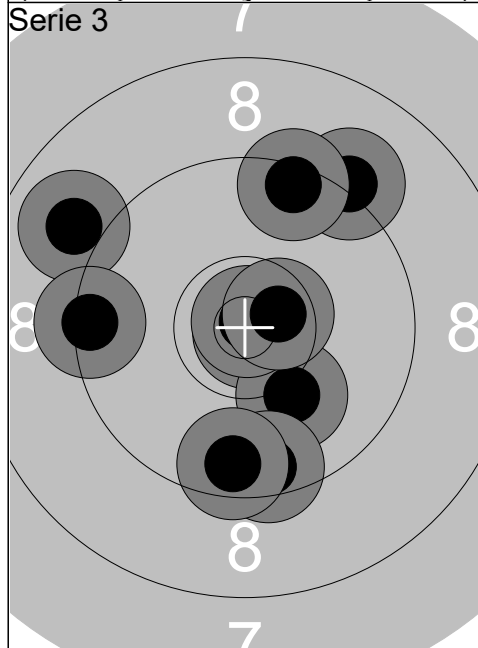

1:	8.9	↖
2:	10.9x	↘
3:	10.1	↘
4:	9.5	↓
5:	10.9x	↗
6:	9.6	↓
7:	10.6x	→
8:	9.1	↗
9:	9.4	←
10:	9.4	↑
Serie		93 (3x)
Total		276 (7x)

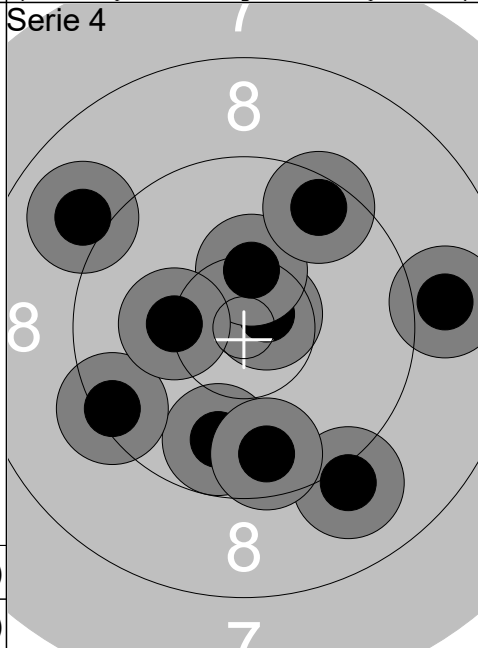

1:	8.9	→
2:	10.7x	↗
3:	9.8	↓
4:	9.0	↖
5:	9.1	↘
6:	10.4x	↑
7:	9.6	↓
8:	9.5	↗
9:	9.4	↖
10:	10.2	←
Serie		92 (2x)
Total		368 (9x)

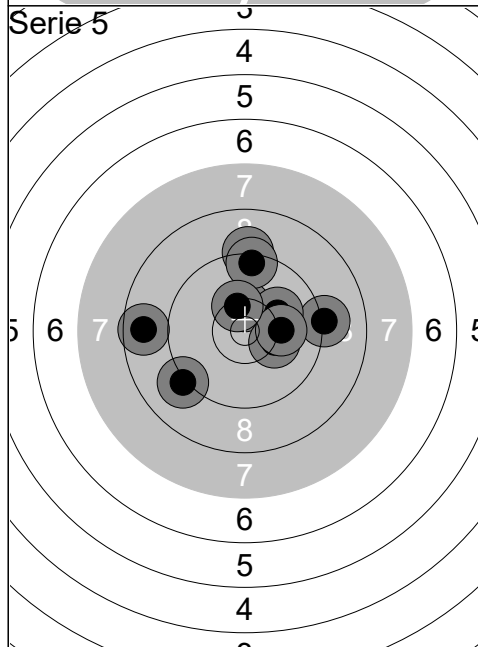

1:	9.1	↖
2:	9.2	→
3:	8.7	←
4:	10.4x	↑
5:	9.2	↑
6:	10.1	↗
7:	9.4	↑
8:	10.3	→
9:	10.1	→
10:	10.4x	↑
Serie		94 (2x)
Total		462 (11x)

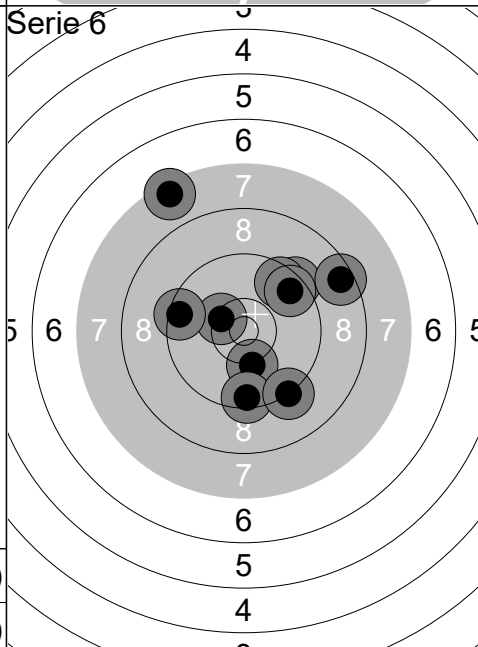

1:	10.2	↓
2:	10.4x	↖
3:	9.4	↗
4:	8.5	↗
5:	9.6	↗
6:	9.5	←
7:	9.5	↓
8:	9.6	↗
9:	9.2	↘
10:	7.5	↖
Serie		89 (1x)
Total		551 (12x)

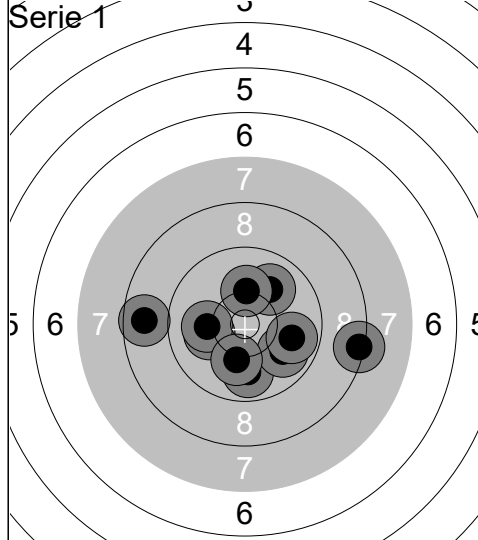

1:	9.9	↓
2:	9.9	↘
3:	10.1	←
4:	10.1	←
5:	8.7	←
6:	9.9	→
7:	8.3	→
8:	10.0	↗
9:	10.2	↑
10:	10.1	↓
Serie		93 (0x)
Total		93 (0x)

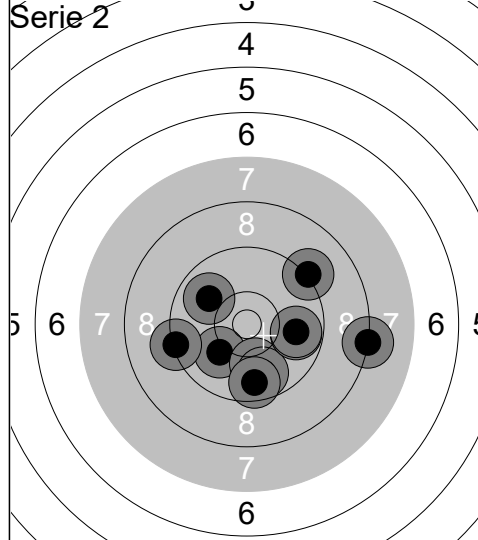

1:	10.1	↙
2:	10.1	↓
3:	8.2	→
4:	9.8	↓
5:	9.2	↗
6:	9.6	↓
7:	9.8	→
8:	9.9	↖
9:	9.3	←
10:	9.8	→
Serie		91 (0x)
Total		184 (0x)

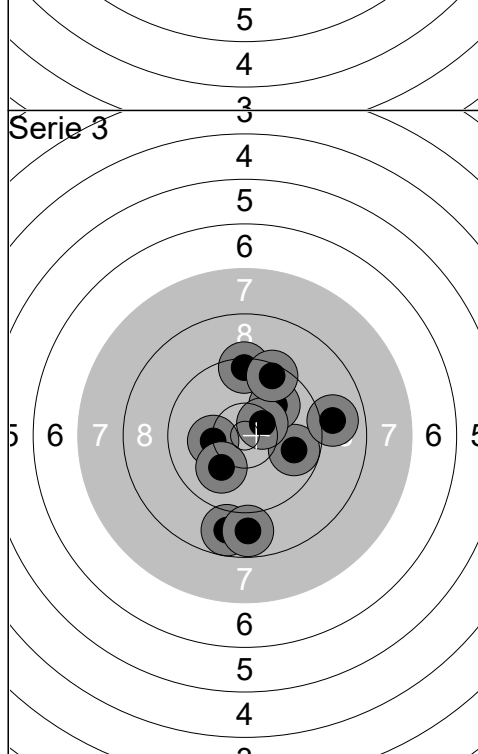

1:	9.8	→
2:	10.0	↗
3:	10.2	←
4:	8.8	↓
5:	8.9	→
6:	8.8	↓
7:	10.5x	↗
8:	10.1	↙
9:	9.4	↑
10:	9.5	↗
Serie		91 (1x)
Total		275 (1x)

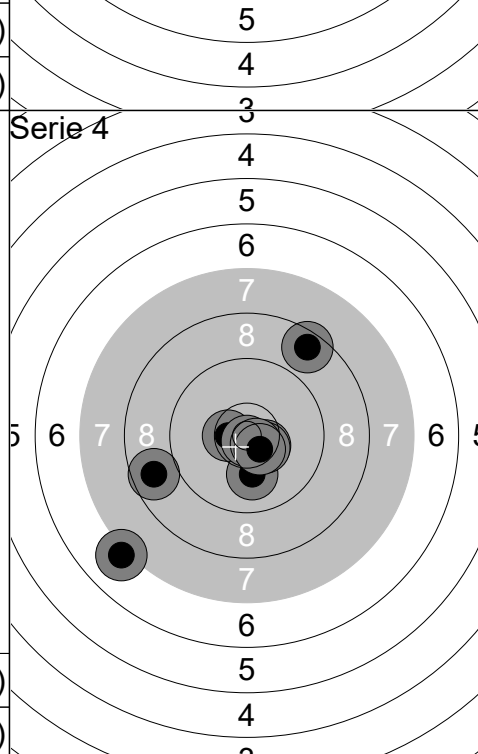

1:	10.1	↓
2:	10.5x	←
3:	8.6	↗
4:	10.5x	↘
5:	10.5x	↘
6:	10.8x	↓
7:	7.1	↙
8:	10.7x	↘
9:	8.7	←
10:	10.5x	↘
Serie		93 (6x)
Total		368 (7x)

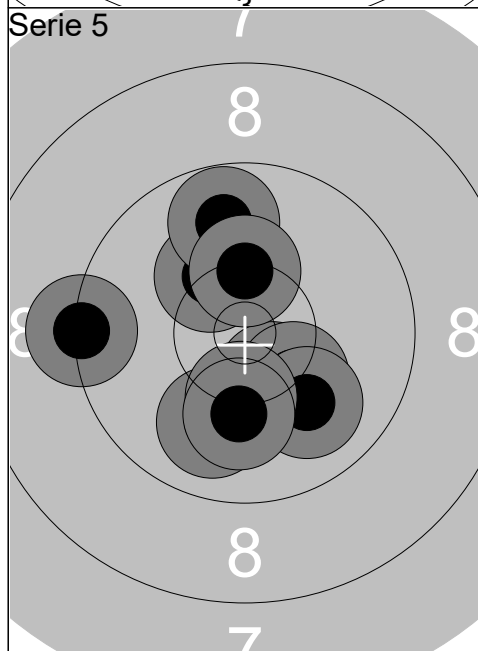

1:	10.4x	↘
2:	10.3	↘
3:	10.0	↘
4:	10.3	↗
5:	10.0	↓
6:	10.3	↓
7:	9.8	↑
8:	10.3	↑
9:	9.3	←
10:	10.1	↓
Serie		98 (1x)
Total		466 (8x)

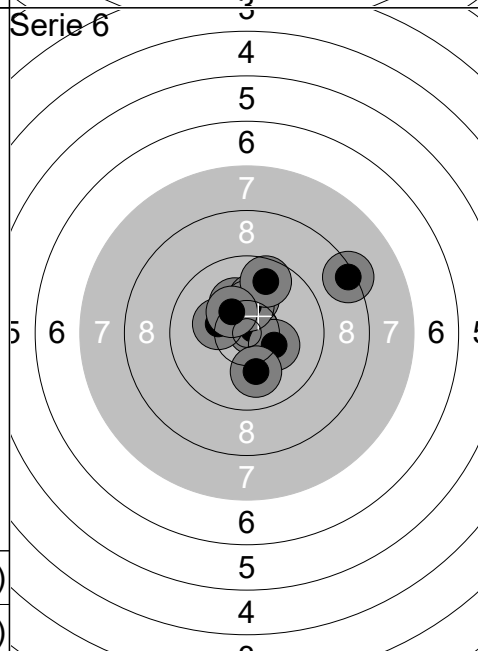

1:	10.8x	↗
2:	10.3	←
3:	10.3	→
4:	10.1	↓
5:	10.2	↗
6:	10.2	↑
7:	8.4	↗
8:	10.3	↑
9:	9.7	↗
10:	10.4x	↖
Serie		97 (2x)
Total		563 (10x)

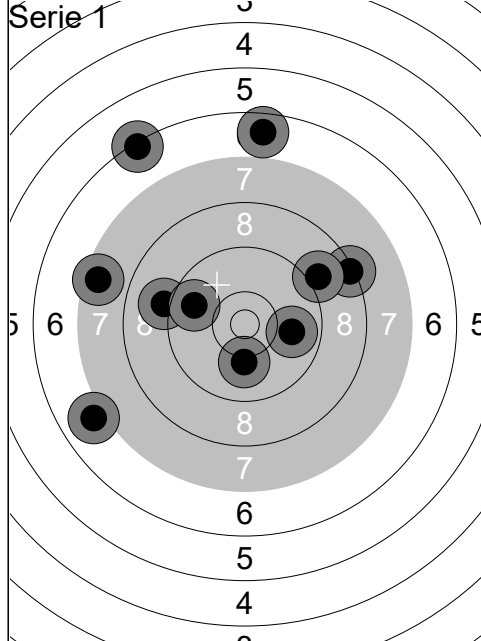

1:	8.3	➔
2:	7.0	↙
3:	6.6	↑
4:	9.1	↙
5:	10.1	↓
6:	9.0	➔
7:	6.3	↗
8:	7.5	↙
9:	9.7	↙
10:	9.9	➔
Serie		80 (0x)
Total		80 (0x)

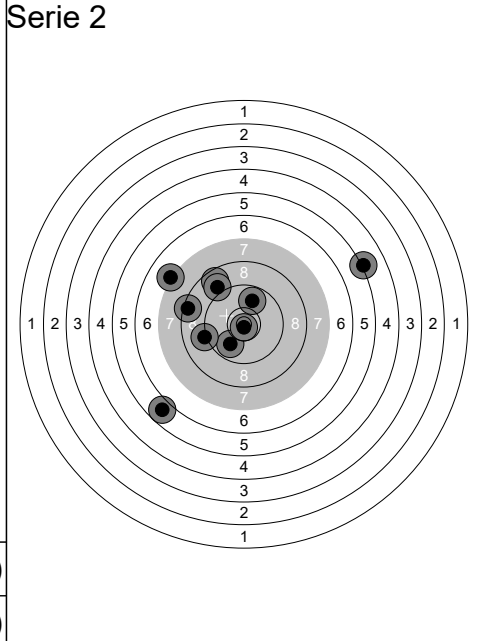

1:	5.2	➔
2:	9.9	↙
3:	9.2	↙
4:	8.7	↗
5:	5.8	↙
6:	9.9	↗
7:	10.8x	↓
8:	7.1	↙
9:	8.4	↙
10:	9.0	↗
Serie		79 (1x)
Total		159 (1x)

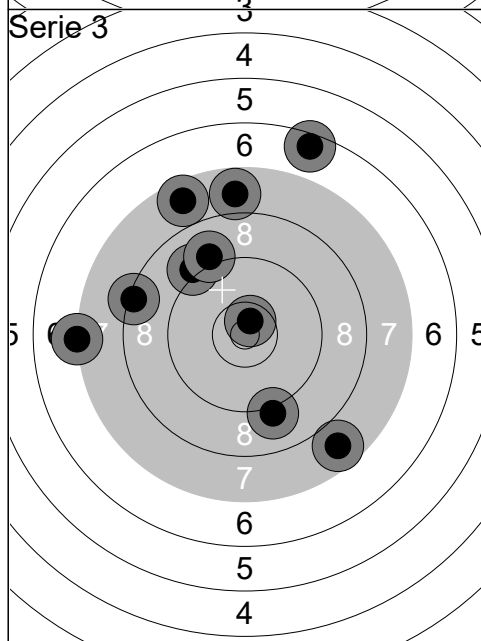

1:	6.5	↗
2:	7.2	↙
3:	9.1	↗
4:	7.8	↑
5:	7.7	↗
6:	7.7	↘
7:	8.3	↙
8:	9.0	↗
9:	9.1	↘
10:	10.6x	↗
Serie		79 (1x)
Total		238 (2x)

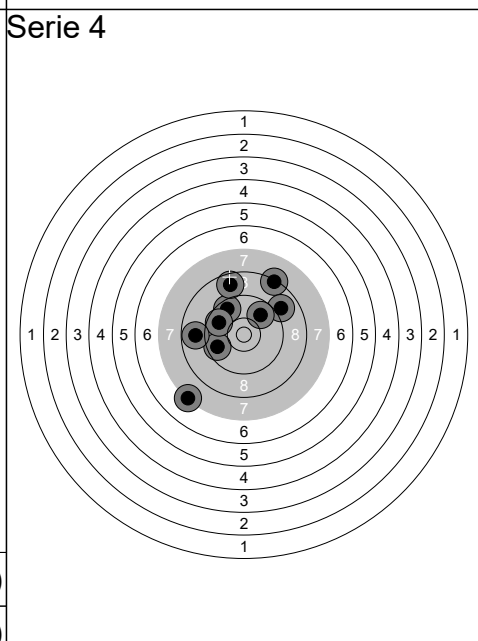

1:	9.6	↗
2:	9.7	↙
3:	9.8	↙
4:	8.7	↑
5:	7.3	↘
6:	0.0	↑
7:	8.3	↗
8:	8.8	↙
9:	9.0	➔
10:	9.8	↗
Serie		76 (0x)
Total		314 (2x)

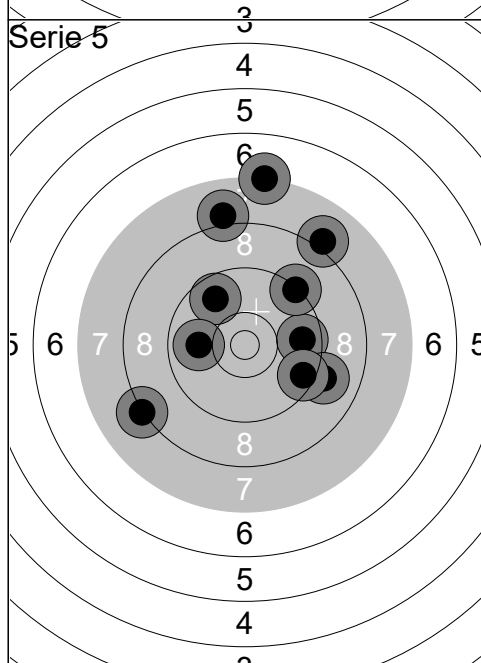

1:	9.7	➔
2:	9.7	↗
3:	8.0	↗
4:	9.3	↗
5:	9.0	➔
6:	8.0	↑
7:	9.9	↙
8:	9.5	➔
9:	8.2	↙
10:	7.2	↑
Serie		85 (0x)
Total		399 (2x)

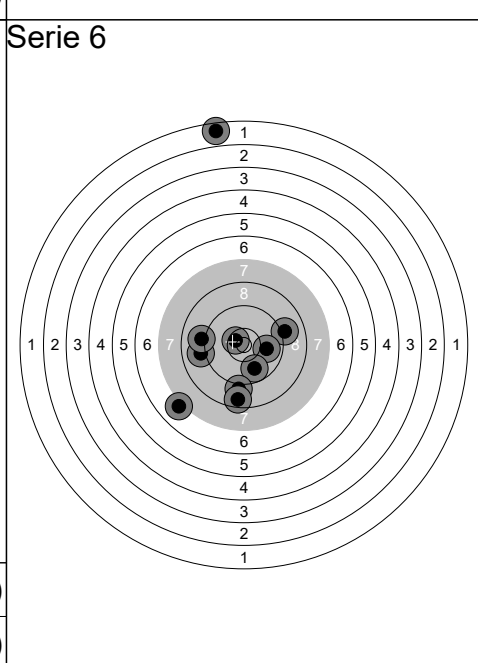

1:	9.0	↙
2:	9.1	➔
3:	9.1	↙
4:	9.9	➔
5:	9.8	↘
6:	9.0	↓
7:	8.6	↓
8:	10.5x	↙
9:	7.1	↙
10:	1.6	↑
Serie		80 (1x)
Total		479 (3x)

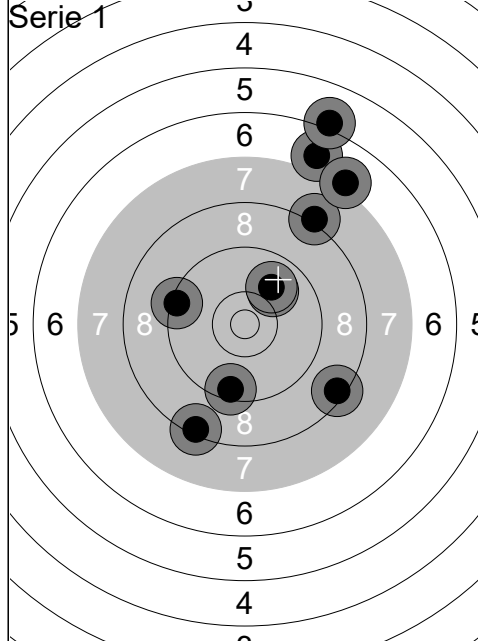

1:	9.5	↓
2:	10.0	↗
3:	9.9	↗
4:	6.9	↗
5:	8.4	↓
6:	6.1	↗
7:	8.4	↘
8:	9.3	←
9:	8.1	↗
10:	7.1	↗
Serie		80 (0x)
Total		80 (0x)

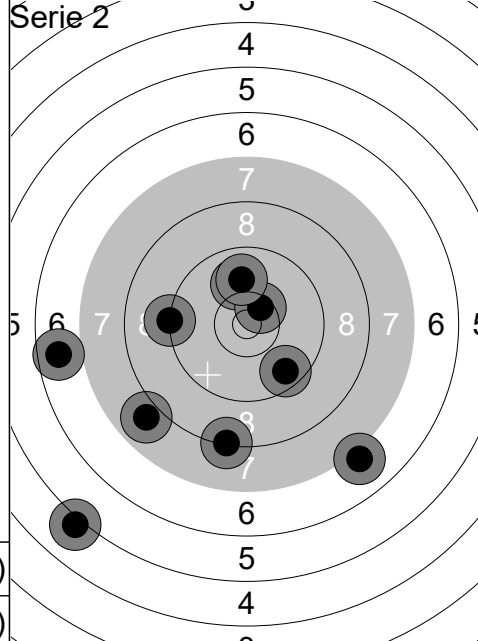

1:	7.9	↙
2:	10.0	↑
3:	10.5x	↗
4:	9.6	↘
5:	7.0	↘
6:	9.2	←
7:	8.3	↓
8:	9.9	↑
9:	5.1	↙
10:	6.7	←
Serie		80 (1x)
Total		160 (1x)

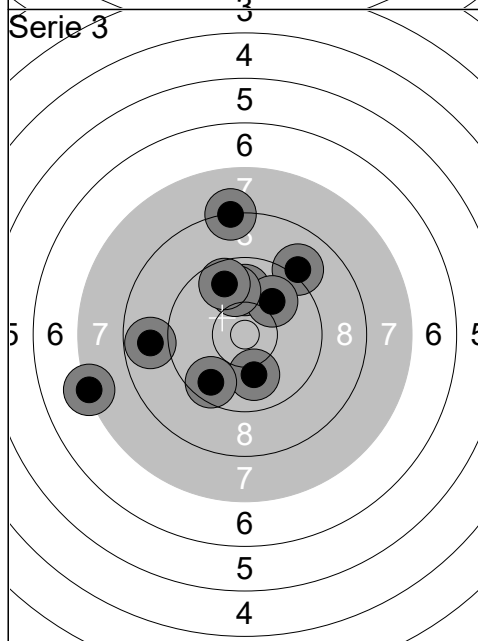

1:	8.2	↑
2:	10.0	↓
3:	9.9	↑
4:	9.1	↗
5:	7.3	←
6:	9.6	↘
7:	10.0	↗
8:	9.9	↑
9:	8.8	←
10:	9.7	↗
Serie		88 (0x)
Total		248 (1x)

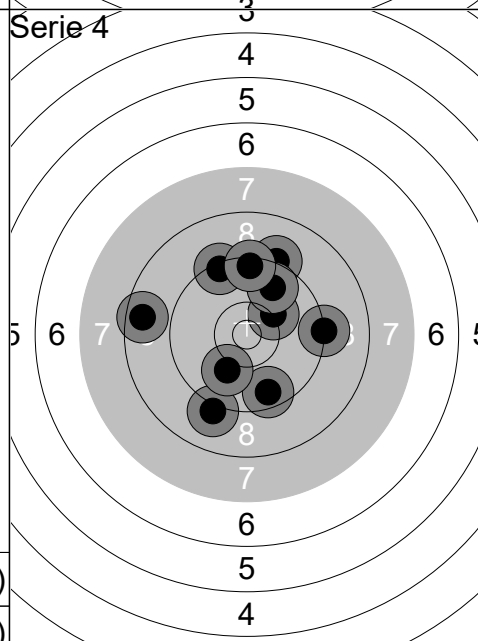

1:	9.1	↘
2:	9.4	↗
3:	9.2	↗
4:	10.2	↗
5:	9.6	↘
6:	8.6	←
7:	9.8	↗
8:	10.0	↘
9:	9.2	→
10:	9.4	↑
Serie		91 (0x)
Total		339 (1x)

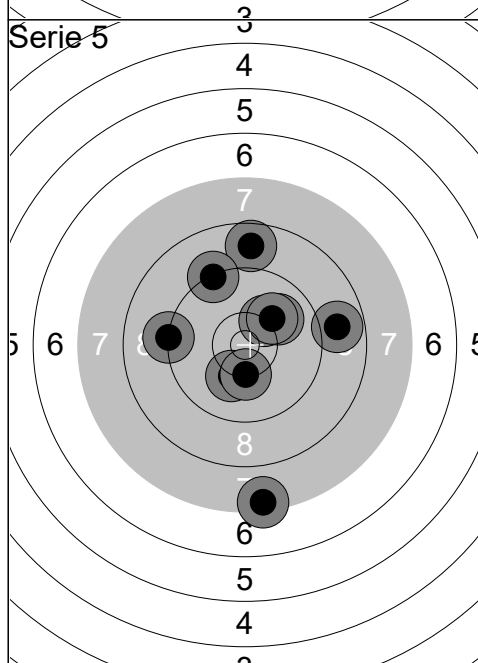

1:	10.2	↗
2:	10.0	↗
3:	10.2	↘
4:	8.7	↑
5:	9.3	↗
6:	9.2	←
7:	10.1	↗
8:	10.3	↓
9:	7.4	↓
10:	8.9	→
Serie		91 (0x)
Total		430 (1x)

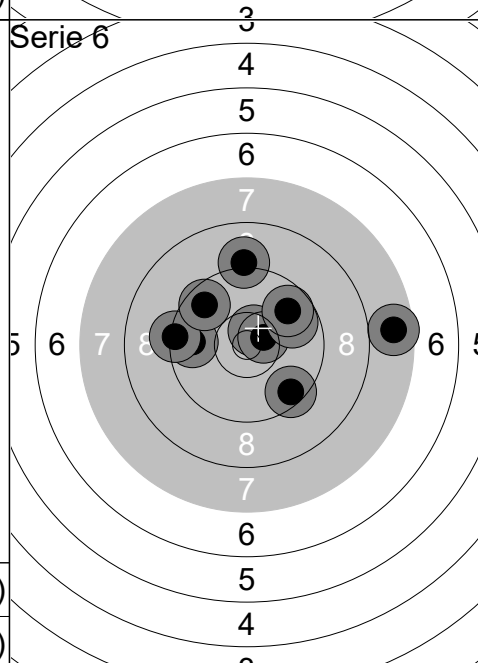

1:	9.7	←
2:	9.3	←
3:	10.6x	↗
4:	9.5	↘
5:	7.7	→
6:	9.6	↖
7:	9.1	↑
8:	10.5x	↗
9:	9.8	↗
10:	9.8	↗
Serie		90 (2x)
Total		520 (3x)

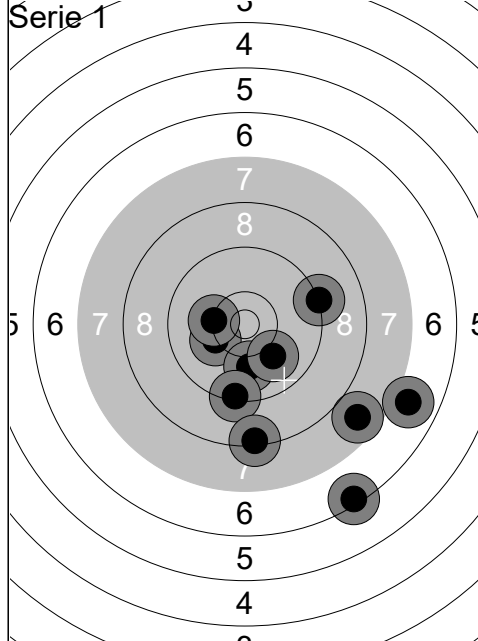

1:	10.2	↙
2:	7.7	↘
3:	10.0	↓
4:	9.3	↓
5:	6.9	↘
6:	6.4	↘
7:	10.3	←
8:	8.3	↓
9:	10.0	↓
10:	9.2	→
Serie	85 (0x)	
Total	85 (0x)	

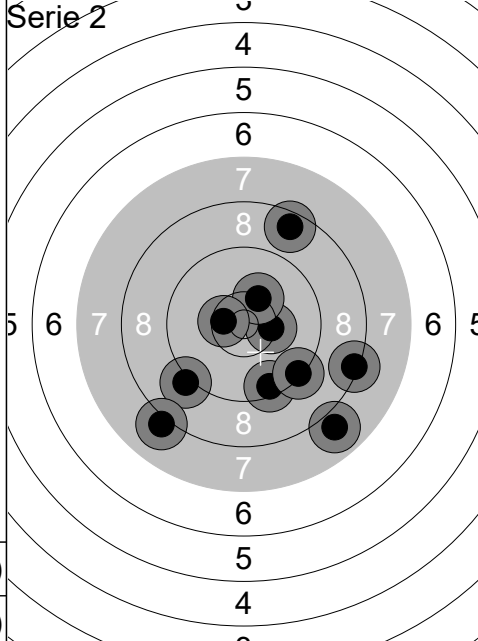

1:	9.4	↘
2:	9.3	↘
3:	8.5	↗
4:	10.3	→
5:	8.3	↘
6:	10.3	↗
7:	9.1	↙
8:	7.9	↘
9:	8.1	↙
10:	10.5x	←
Serie	88 (1x)	
Total	173 (1x)	

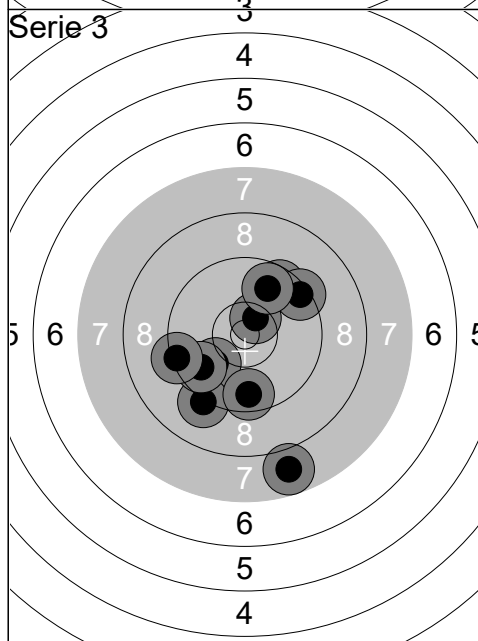

1:	10.5x	↗
2:	9.6	↗
3:	10.0	↙
4:	9.4	↗
5:	9.2	↘
6:	9.7	↙
7:	9.6	↓
8:	9.3	←
9:	7.8	↓
10:	9.8	↗
Serie	90 (1x)	
Total	263 (2x)	

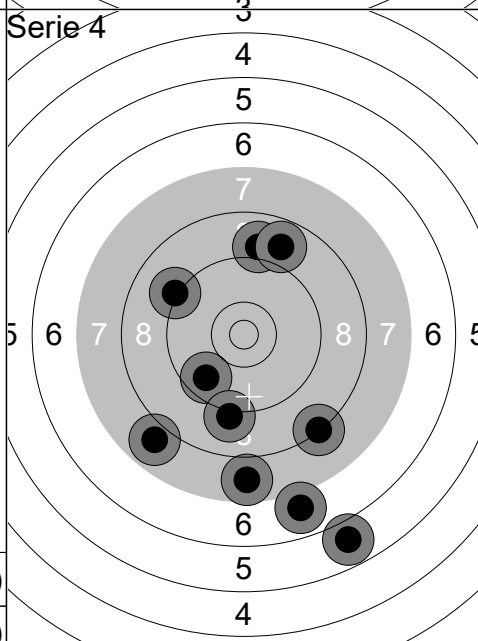

1:	9.7	↙
2:	9.1	↓
3:	9.0	↑
4:	8.8	↗
5:	7.7	↓
6:	7.9	↙
7:	9.1	↖
8:	6.9	↓
9:	5.8	↓
10:	8.3	↘
Serie	77 (0x)	
Total	340 (2x)	

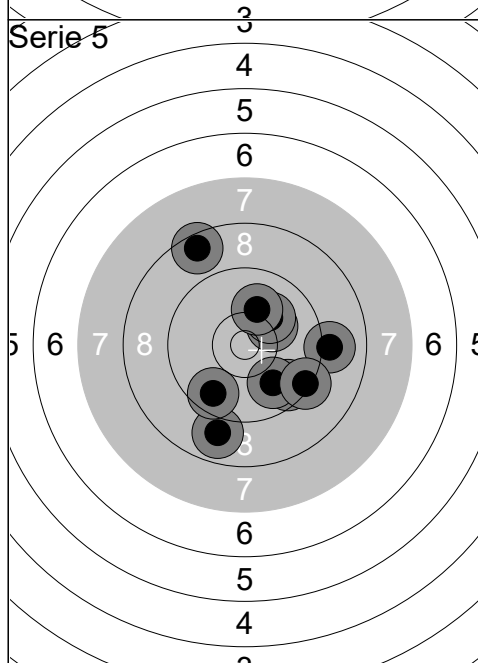

1:	10.2	↗
2:	9.6	↘
3:	8.5	↗
4:	9.1	→
5:	10.1	↗
6:	8.9	↓
7:	9.9	↘
8:	9.7	↘
9:	9.3	↘
10:	10.1	↗
Serie	91 (0x)	
Total	431 (2x)	

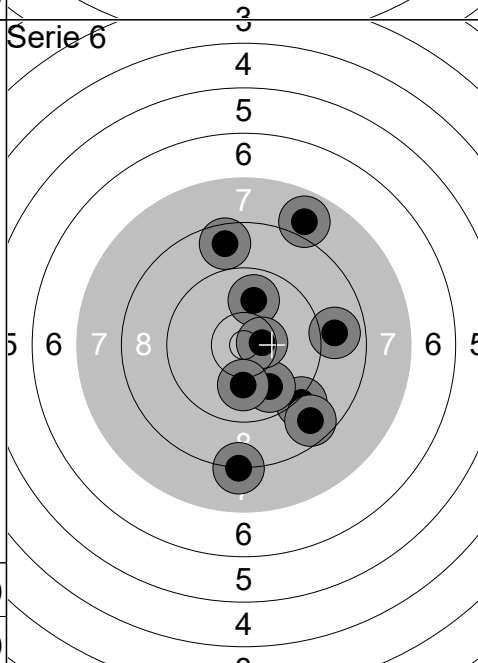

1:	8.9	→
2:	9.9	↑
3:	8.6	↑
4:	9.1	↘
5:	9.9	↘
6:	7.9	↗
7:	8.7	↘
8:	10.5x	→
9:	10.0	↓
10:	8.2	↓
Serie	86 (1x)	
Total	517 (3x)	

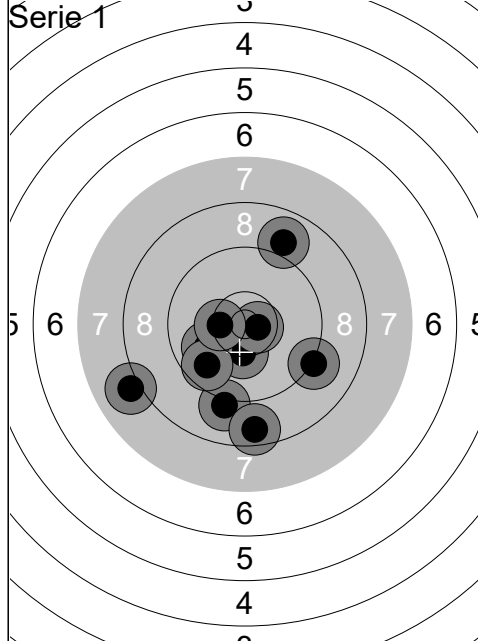

1:	9.2	↘
2:	9.1	↓
3:	8.9	↗
4:	10.3	↓
5:	8.6	↓
6:	10.0	↙
7:	10.6x	→
8:	9.7	↘
9:	10.4x	↙
10:	8.0	↙
Serie		91 (2x)
Total		91 (2x)

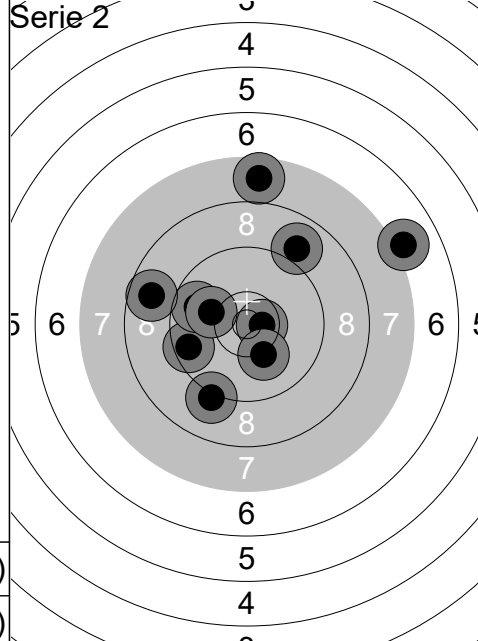

1:	9.6	↙
2:	9.8	↙
3:	7.7	↑
4:	8.9	↗
5:	9.1	↓
6:	8.7	↙
7:	10.1	↙
8:	7.0	↗
9:	10.6x	→
10:	10.2	↓
Serie		87 (1x)
Total		178 (3x)

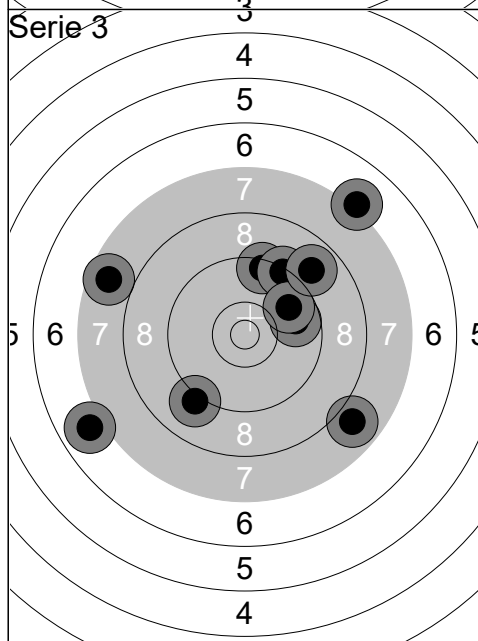

1:	9.4	↑
2:	9.3	↗
3:	6.9	↙
4:	7.7	↙
5:	9.8	→
6:	7.1	↗
7:	9.8	↗
8:	9.1	↘
9:	8.9	↗
10:	7.9	↘
Serie		80 (0x)
Total		258 (3x)

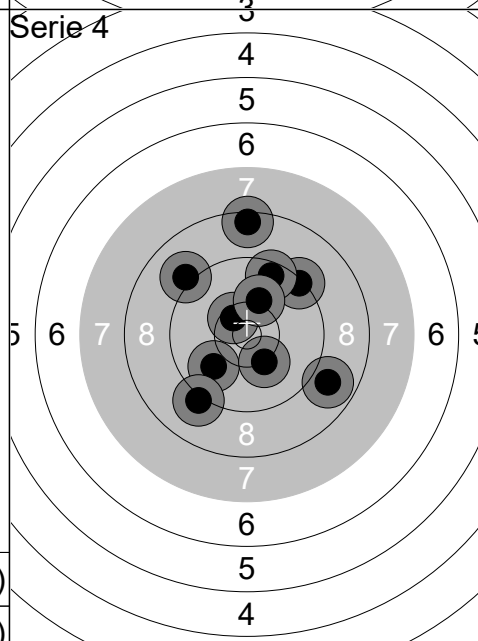

1:	8.8	↘
2:	9.9	↘
3:	9.3	↗
4:	10.5x	↖
5:	10.2	↓
6:	9.1	↖
7:	9.5	↗
8:	8.4	↑
9:	10.1	↑
10:	9.1	↘
Serie		91 (1x)
Total		349 (4x)

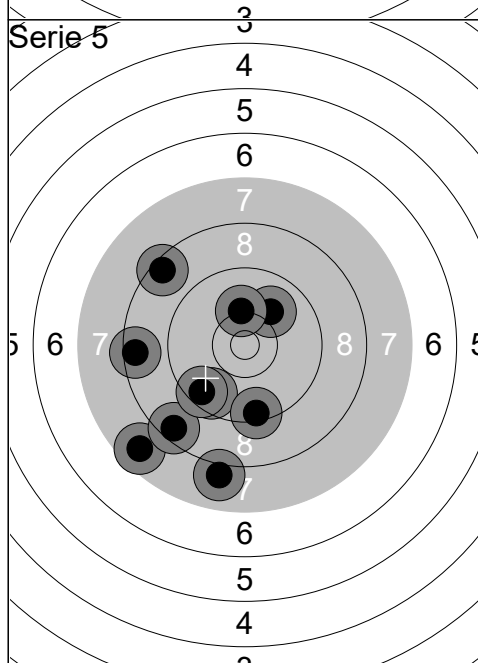

1:	10.0	↗
2:	10.2	↑
3:	7.7	↘
4:	8.0	↓
5:	8.5	↙
6:	9.6	↘
7:	8.5	↘
8:	8.5	↖
9:	9.5	↘
10:	9.4	↓
Serie		86 (0x)
Total		435 (4x)

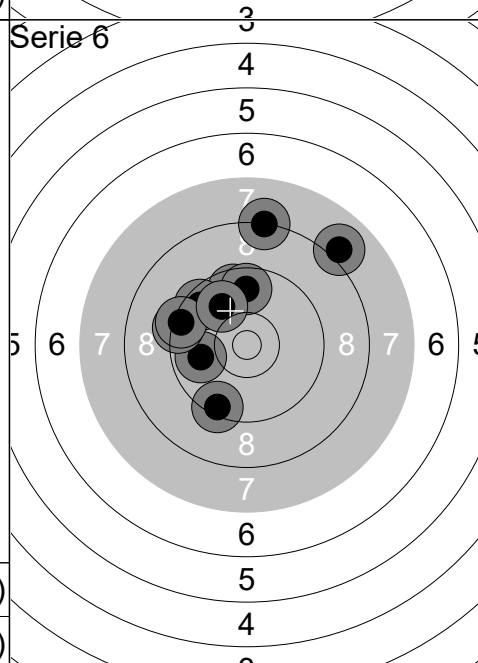

1:	8.2	↑
2:	9.9	↙
3:	9.7	↑
4:	8.0	↗
5:	9.7	↑
6:	9.4	↙
7:	9.6	↖
8:	9.4	↙
9:	9.9	↗
10:	9.4	↓
Serie		88 (0x)
Total		523 (4x)

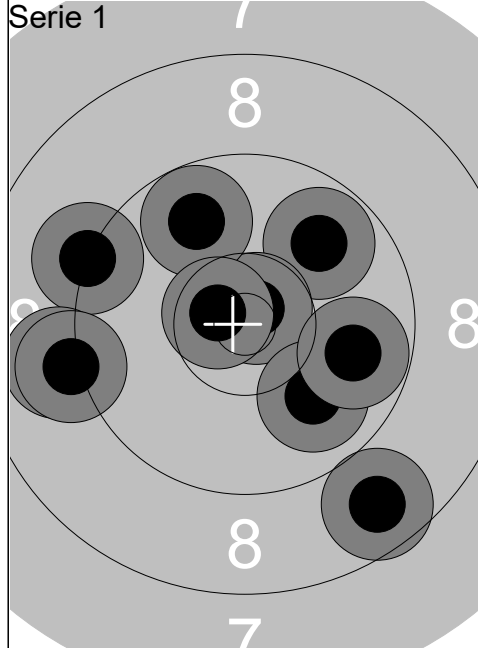

1:	9.2	←
2:	9.0	←
3:	9.8	↗
4:	9.1	←
5:	8.7	↘
6:	10.7x	↗
7:	9.8	↗
8:	10.6x	←
9:	9.9	↘
10:	9.8	→
Serie		91 (2x)
Total		91 (2x)

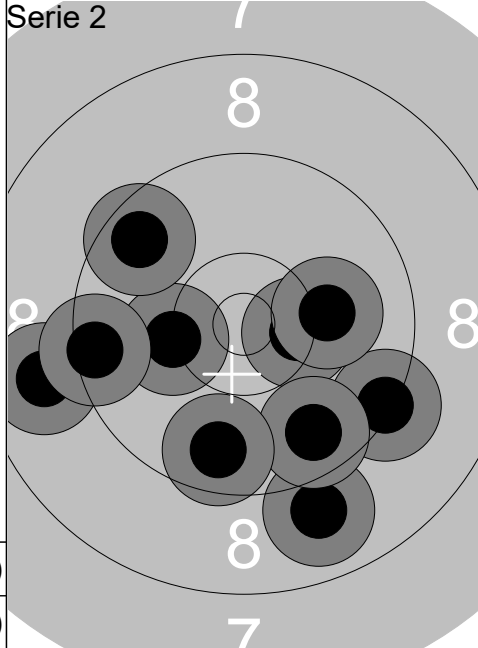

1:	10.4x	→
2:	9.3	↘
3:	10.2	←
4:	9.6	↗
5:	8.9	↘
6:	10.1	→
7:	8.9	←
8:	9.7	↘
9:	9.4	←
10:	9.7	↘
Serie		91 (1x)
Total		182 (3x)

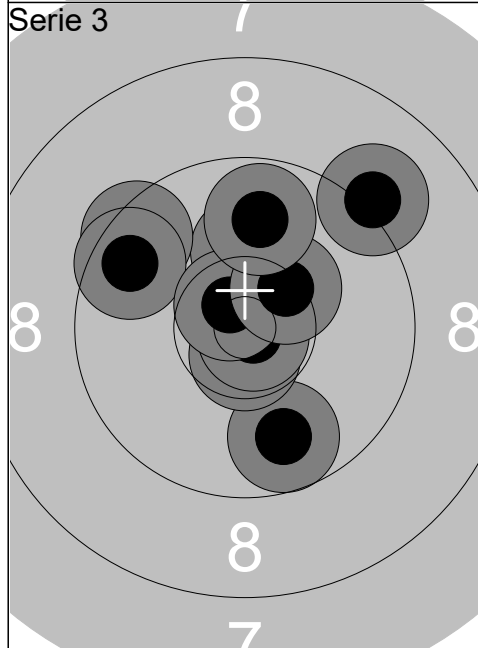

1:	10.2	↑
2:	9.8	↘
3:	10.7x	↘
4:	9.1	↗
5:	9.5	↗
6:	10.8x	↘
7:	9.6	←
8:	10.7x	↗
9:	10.4x	↗
10:	9.8	↑
Serie		95 (4x)
Total		277 (7x)

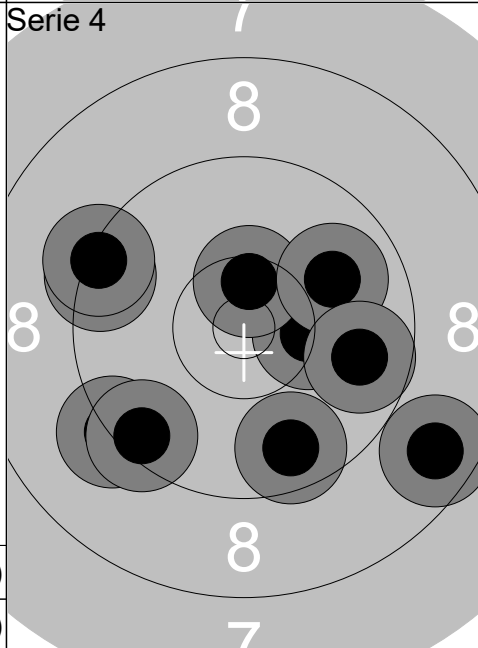

1:	9.6	↘
2:	8.6	↘
3:	9.3	↙
4:	10.3	→
5:	10.5x	↑
6:	9.9	↗
7:	9.4	↙
8:	9.7	→
9:	9.4	←
10:	9.3	↙
Serie		91 (1x)
Total		368 (8x)

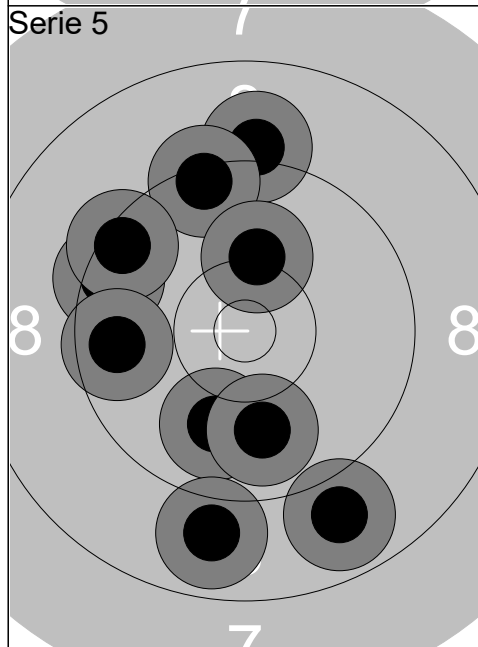

1:	10.0	↘
2:	9.5	←
3:	8.9	↘
4:	9.1	↑
5:	9.9	↘
6:	9.4	↑
7:	9.4	↖
8:	8.9	↘
9:	10.2	↑
10:	9.6	←
Serie		90 (0x)
Total		458 (8x)

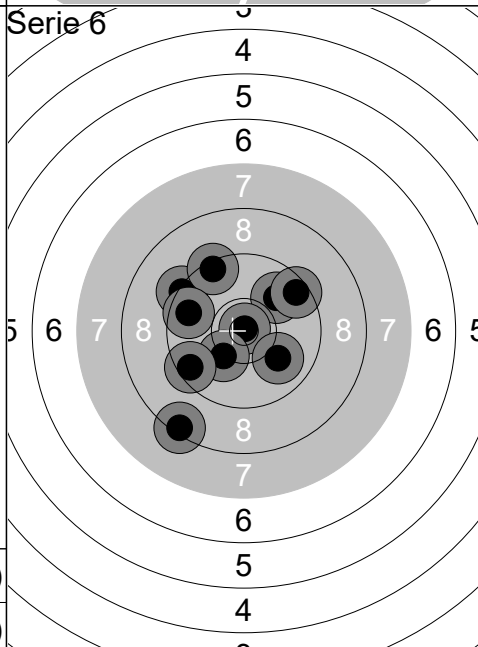

1:	9.9	↗
2:	9.5	↗
3:	9.3	↖
4:	8.4	↘
5:	10.9x	↑
6:	10.0	↘
7:	10.2	↘
8:	9.4	↗
9:	9.5	←
10:	9.7	←
Serie		92 (1x)
Total		550 (9x)

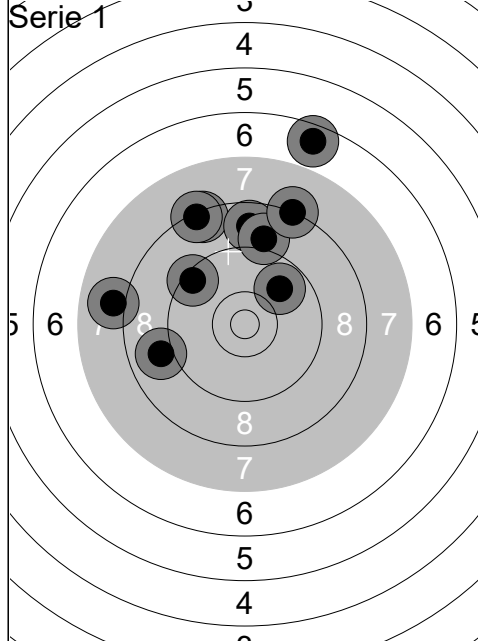

1:	9.8	↗
2:	9.4	↖
3:	8.4	↗
4:	8.0	←
5:	8.7	↑
6:	6.6	↗
7:	9.0	↑
8:	8.3	↗
9:	8.2	↗
10:	9.0	←
Serie		82 (0x)
Total		82 (0x)

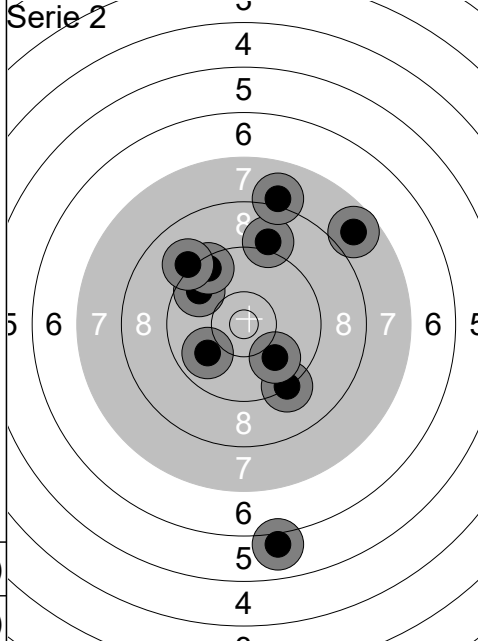

1:	9.2	↘
2:	9.7	↖
3:	6.0	↓
4:	9.9	↖
5:	9.0	↑
6:	8.0	↗
7:	9.5	↗
8:	7.8	↗
9:	9.1	↖
10:	9.9	↘
Serie		84 (0x)
Total		166 (0x)

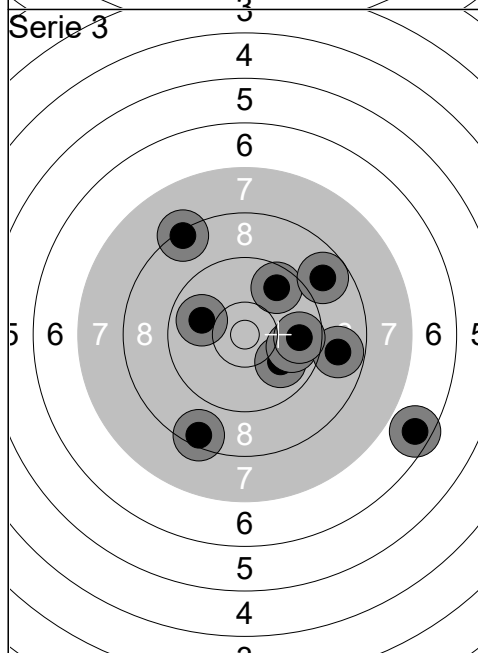

1:	9.9	↘
2:	9.9	→
3:	9.7	↗
4:	8.3	↗
5:	9.9	←
6:	8.5	↓
7:	8.8	↗
8:	8.8	→
9:	6.6	↘
10:	9.7	→
Serie		83 (0x)
Total		249 (0x)

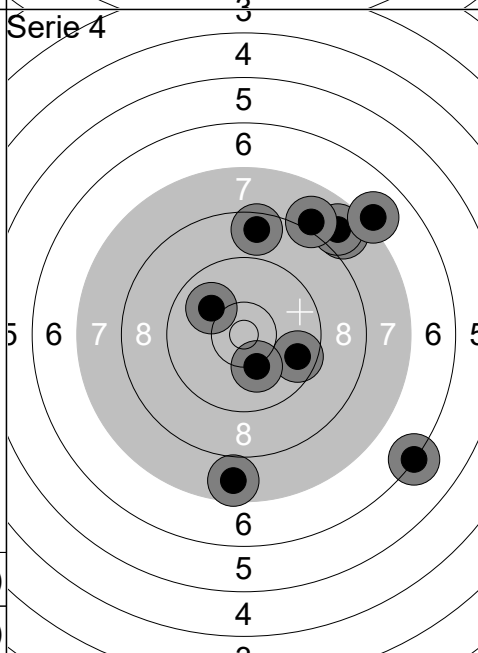

1:	7.8	↗
2:	7.7	↓
3:	6.3	↘
4:	7.8	↗
5:	9.7	→
6:	8.0	↗
7:	10.0	↖
8:	8.6	↑
9:	7.1	↗
10:	10.2	↘
Serie		79 (0x)
Total		328 (0x)

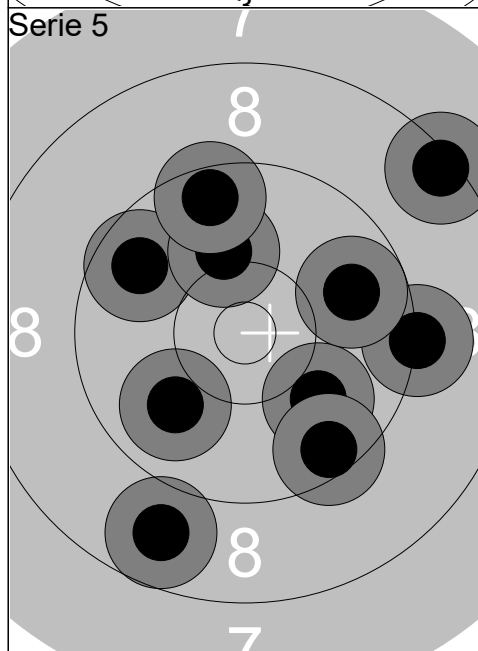

1:	10.0	↘
2:	9.7	↖
3:	9.9	↘
4:	9.5	↘
5:	9.2	→
6:	9.8	→
7:	10.1	↑
8:	8.8	↓
9:	8.4	↗
10:	9.5	↑
Serie		90 (0x)
Total		418 (0x)

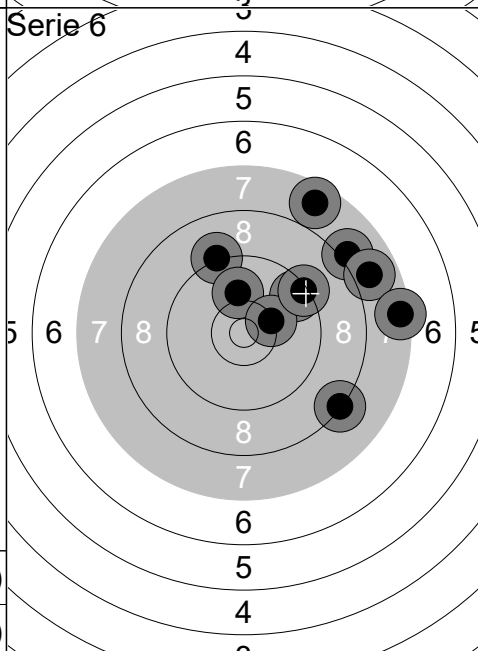

1:	8.0	↗
2:	9.5	↗
3:	9.2	↑
4:	10.0	↑
5:	10.3	↗
6:	7.9	→
7:	7.6	↗
8:	7.4	→
9:	9.3	↗
10:	8.3	↘
Serie		84 (0x)
Total		502 (0x)

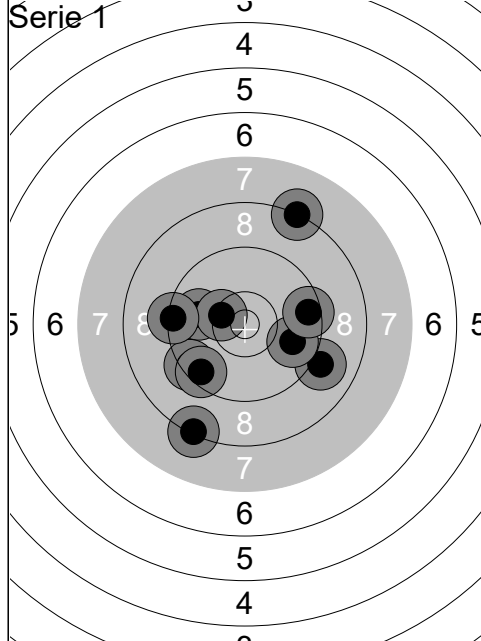

1:	9.9	←
2:	10.4x	←
3:	9.4	←
4:	9.3	←
5:	9.5	↙
6:	8.3	↘
7:	8.2	↗
8:	9.0	↘
9:	9.8	↘
10:	9.5	→
Serie	89	(1x)
Total	89	(1x)

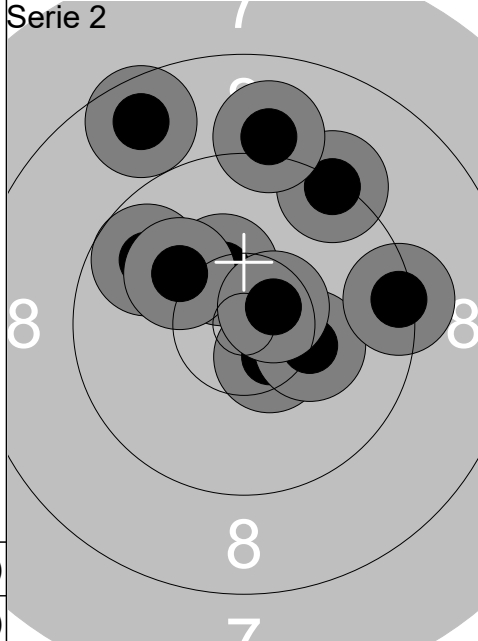

1:	8.7	↗
2:	10.5x	↘
3:	10.2	→
4:	10.4	↗
5:	9.8	↖
6:	9.3	↗
7:	10.1	↖
8:	9.4	→
9:	10.6x	↗
10:	9.0	↑
Serie	94	(2x)
Total	183	(3x)

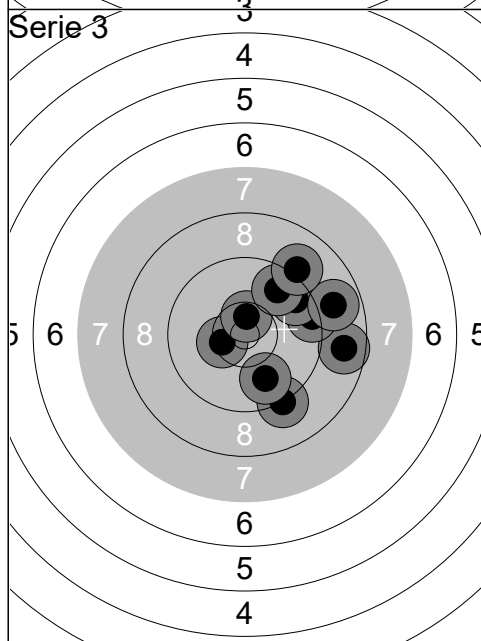

1:	8.7	→
2:	10.4x	←
3:	9.2	↘
4:	9.4	→
5:	10.5x	↑
6:	9.6	↗
7:	9.9	↘
8:	8.9	→
9:	9.7	↗
10:	9.1	↗
Serie	90	(2x)
Total	273	(5x)

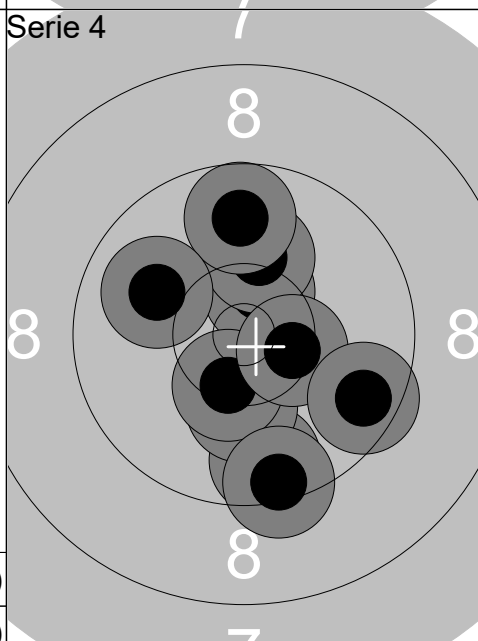

1:	9.7	↘
2:	10.2	↘
3:	10.5x	↗
4:	10.4x	↘
5:	10.2	↑
6:	9.8	↑
7:	10.4x	→
8:	10.0	↖
9:	9.6	↘
10:	9.4	↘
Serie	96	(3x)
Total	369	(8x)

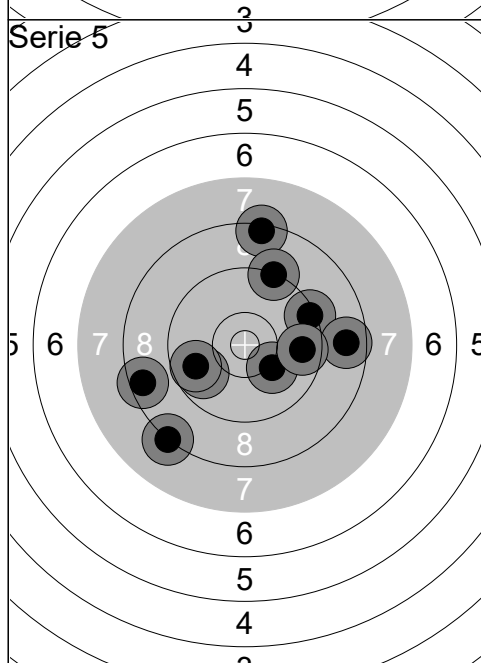

1:	9.8	←
2:	8.4	↑
3:	9.3	→
4:	8.2	↘
5:	9.2	↗
6:	8.5	←
7:	8.7	→
8:	10.1	↘
9:	9.8	←
10:	9.6	→
Serie	87	(0x)
Total	456	(8x)

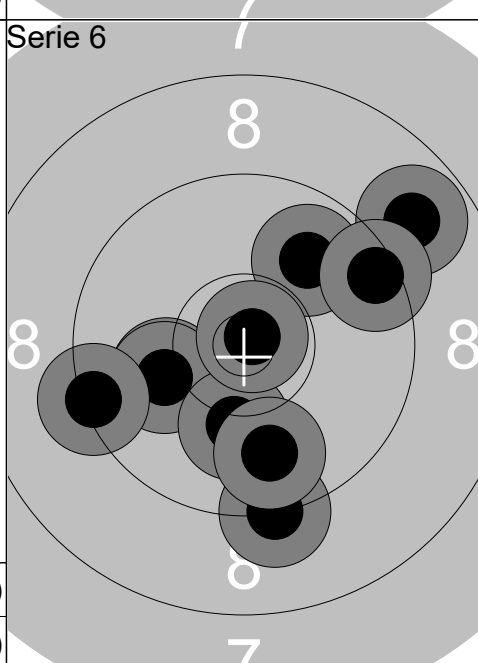

1:	8.8	↗
2:	10.1	←
3:	9.2	↘
4:	10.1	←
5:	9.9	↗
6:	10.1	↘
7:	10.8x	↗
8:	9.8	↘
9:	9.3	←
10:	9.4	↗
Serie	93	(1x)
Total	549	(9x)

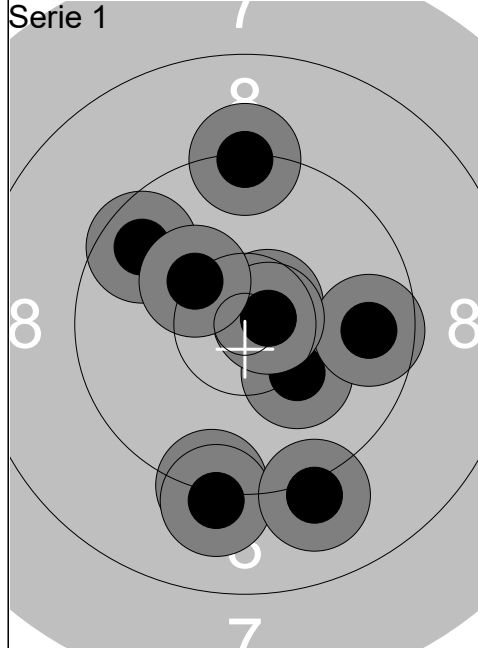

1:	9.3	↓
2:	10.7x	↗
3:	9.1	↓
4:	9.3	↑
5:	10.2	↘
6:	9.6	↗
7:	9.1	↓
8:	9.7	→
9:	10.7x	→
10:	10.3	↖
Serie	94	(2x)
Total	94	(2x)

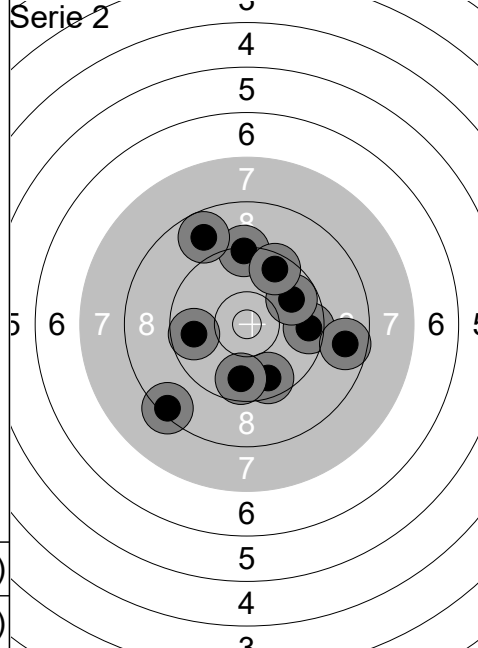

1:	9.6	→
2:	9.3	↑
3:	9.7	↓
4:	9.8	↗
5:	9.7	↓
6:	8.4	↙
7:	9.6	↗
8:	8.7	→
9:	8.8	↖
10:	9.7	←
Serie	87	(0x)
Total	181	(2x)

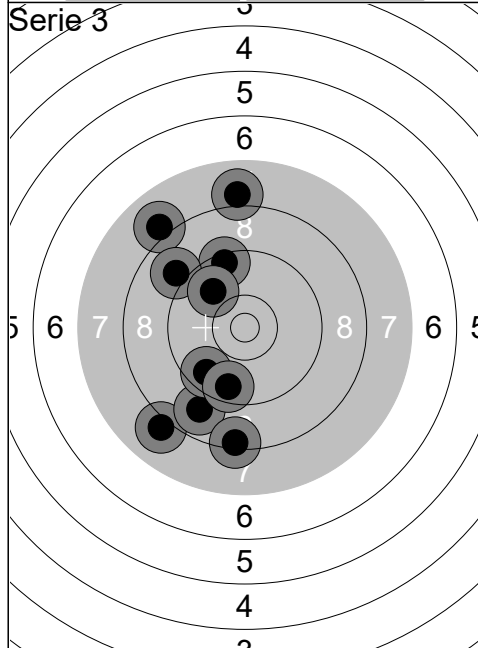

1:	8.0	↖
2:	9.4	↑
3:	9.0	↖
4:	8.0	↙
5:	8.9	↙
6:	9.6	↙
7:	9.9	↗
8:	8.4	↓
9:	9.6	↙
10:	8.0	↑
Serie	85	(0x)
Total	266	(2x)

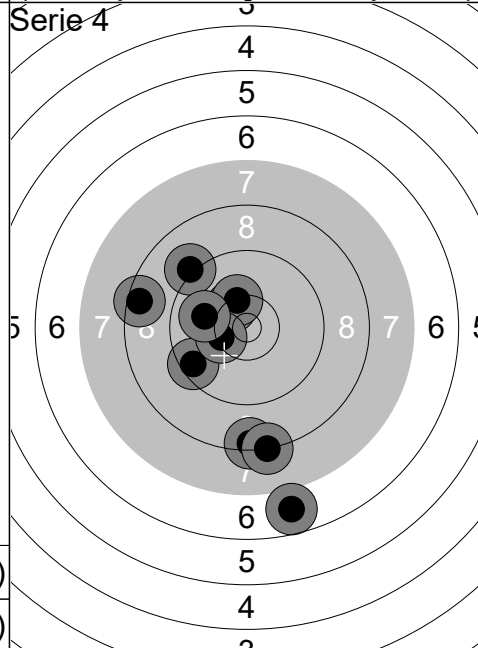

1:	10.4x	↖
2:	8.5	←
3:	10.3	↑
4:	9.5	↙
5:	8.4	↓
6:	10.3	←
7:	6.8	↓
8:	9.1	↗
9:	8.2	↓
10:	10.0	←
Serie	88	(1x)
Total	354	(3x)

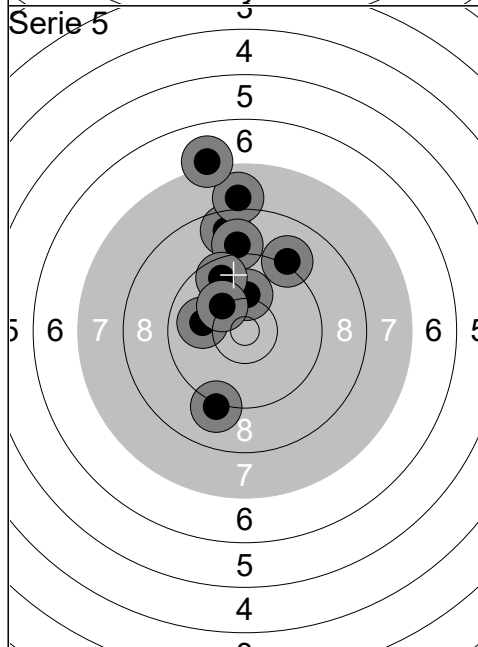

1:	8.7	↑
2:	8.0	↑
3:	7.1	↑
4:	9.0	↑
5:	10.0	←
6:	9.1	↙
7:	9.1	↗
8:	10.1	↑
9:	9.6	↗
10:	10.2	↖
Serie	89	(0x)
Total	443	(3x)

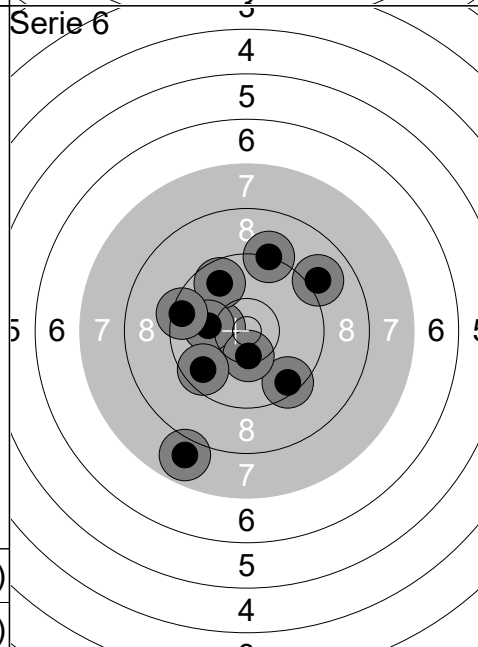

1:	9.2	↑
2:	10.3	←
3:	9.5	↘
4:	9.7	↗
5:	10.1	←
6:	10.4x	↓
7:	9.6	↙
8:	7.9	↙
9:	9.0	↗
10:	9.4	←
Serie	91	(1x)
Total	534	(4x)

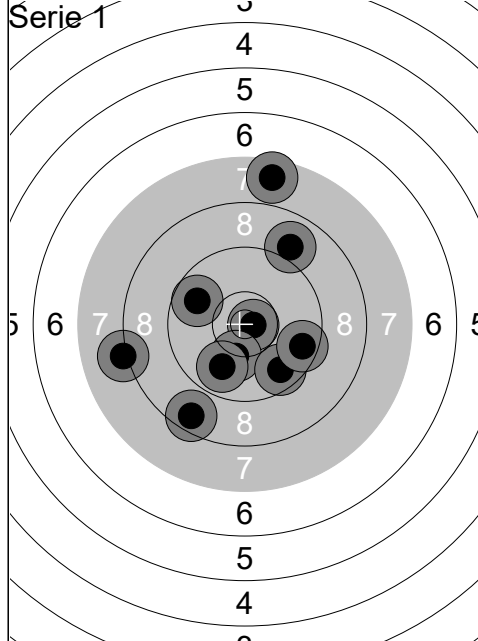

1:	9.0	↗
2:	9.8	↖
3:	7.6	↗
4:	10.8x	→
5:	10.2	↘
6:	9.9	↘
7:	9.7	↘
8:	8.1	↖
9:	9.6	→
10:	8.6	↘
Serie		88 (1x)
Total		88 (1x)

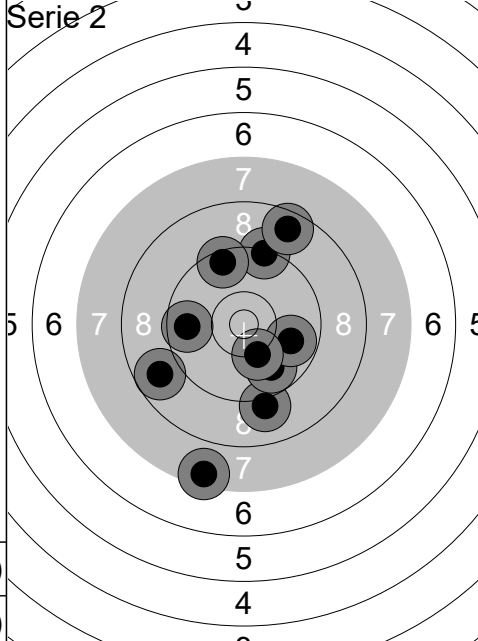

1:	7.5	↘
2:	9.1	↘
3:	9.7	↖
4:	9.8	↘
5:	9.8	→
6:	10.2	↘
7:	9.3	↗
8:	8.6	↗
9:	8.8	↖
10:	9.5	↗
Serie		87 (0x)
Total		175 (1x)

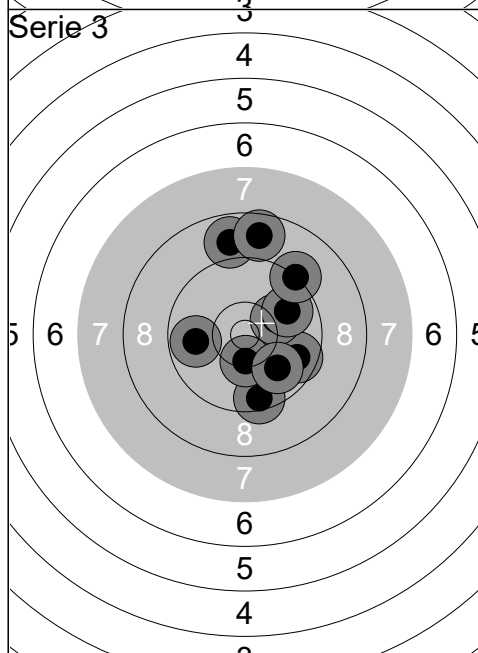

1:	9.7	→
2:	9.5	↘
3:	8.9	↗
4:	10.2	→
5:	10.4x	↘
6:	9.9	↘
7:	9.9	→
8:	8.7	↗
9:	9.8	↖
10:	9.2	↗
Serie		90 (1x)
Total		265 (2x)

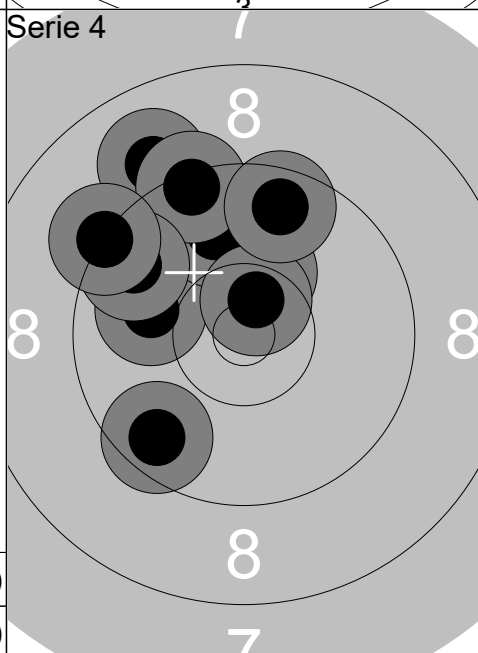

1:	10.0	↖
2:	10.3	↗
3:	9.9	↗
4:	9.0	↗
5:	9.6	↘
6:	9.4	↗
7:	9.6	↖
8:	10.6x	↗
9:	9.2	↖
10:	9.6	↗
Serie		93 (1x)
Total		358 (3x)

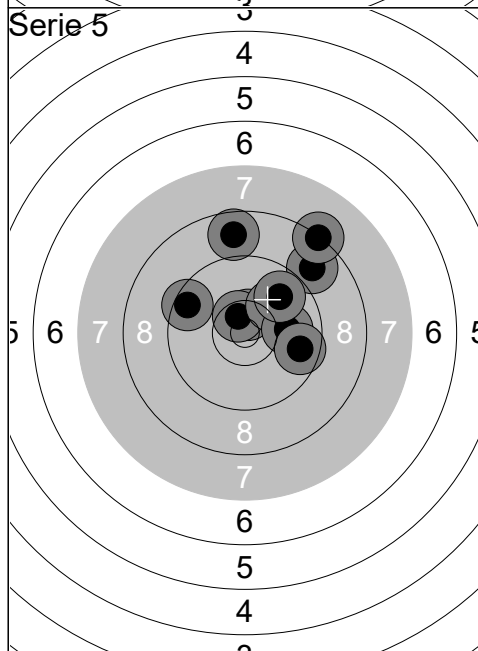

1:	9.5	↖
2:	10.5x	↗
3:	10.5x	↗
4:	8.9	↗
5:	10.1	↗
6:	8.7	↗
7:	8.3	↗
8:	10.0	→
9:	9.8	↗
10:	9.7	→
Serie		91 (2x)
Total		449 (5x)

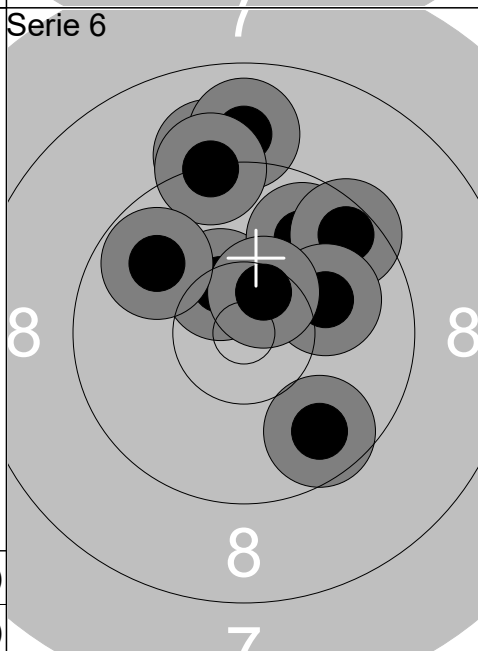

1:	10.4x	↗
2:	9.1	↗
3:	9.7	↘
4:	9.8	↗
5:	8.9	↗
6:	9.5	↗
7:	10.0	→
8:	9.3	↗
9:	10.5x	↗
10:	9.8	↖
Serie		92 (2x)
Total		541 (7x)

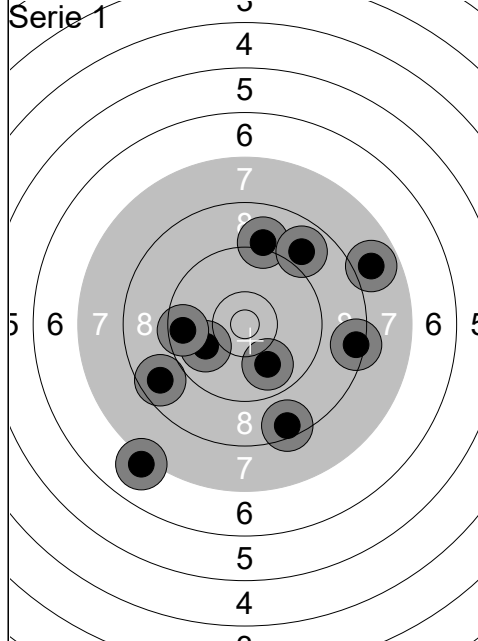

1:	8.5	↘
2:	9.9	↙
3:	9.1	↗
4:	9.5	↔
5:	8.4	→
6:	8.9	↗
7:	7.1	↘
8:	7.8	→
9:	9.9	↘
10:	8.7	↙
Serie		82 (0x)
Total		82 (0x)

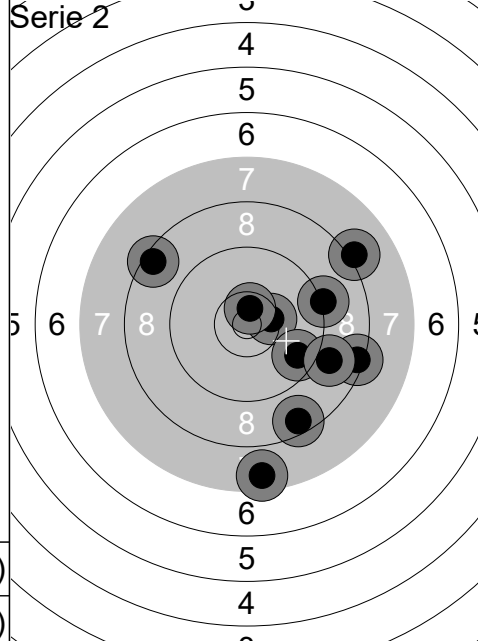

1:	8.1	↗
2:	10.4x	→
3:	8.4	→
4:	9.6	↘
5:	8.5	↘
6:	9.2	→
7:	8.9	→
8:	8.4	↖
9:	7.6	↓
10:	10.6x	↑
Serie		85 (2x)
Total		167 (2x)

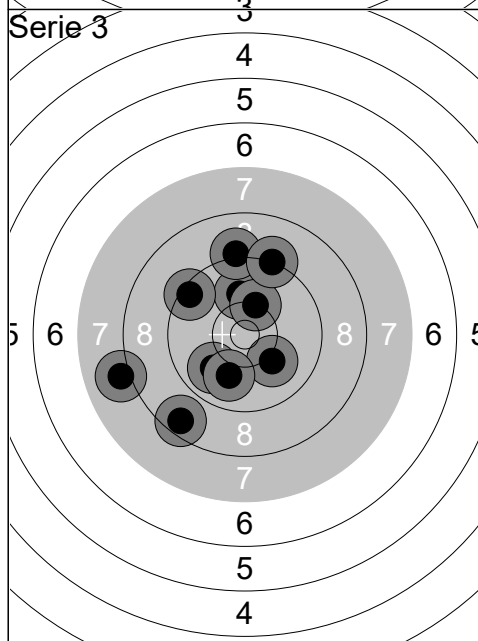

1:	8.0	↔
2:	8.5	↘
3:	10.0	↑
4:	10.1	↘
5:	9.9	↘
6:	10.0	↓
7:	10.2	↗
8:	9.1	↑
9:	9.4	↖
10:	9.2	↗
Serie		92 (0x)
Total		259 (2x)

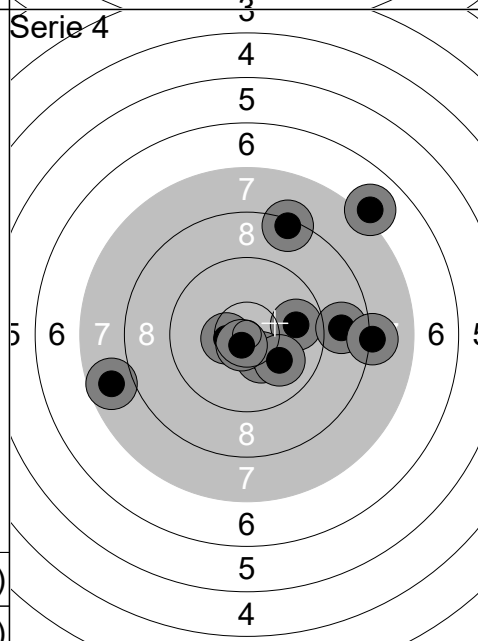

1:	9.8	→
2:	8.4	↗
3:	10.4	↘
4:	8.8	→
5:	10.0	↘
6:	10.5x	↔
7:	8.2	→
8:	10.7x	↘
9:	7.7	↔
10:	7.0	↗
Serie		87 (2x)
Total		346 (4x)

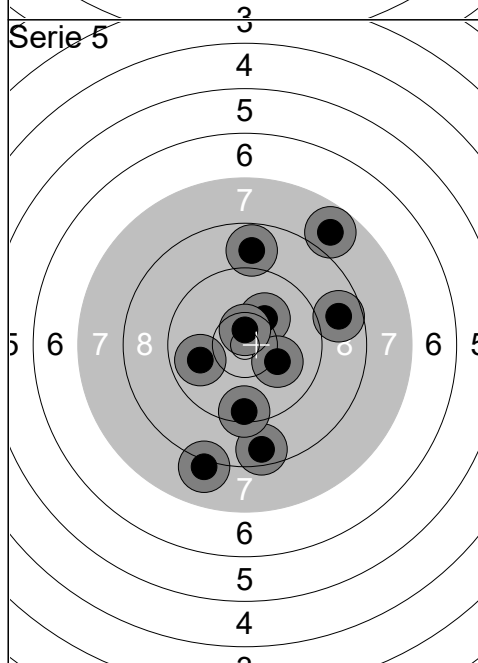

1:	8.1	↘
2:	7.8	↗
3:	10.2	↗
4:	10.1	→
5:	8.8	↑
6:	8.8	→
7:	8.6	↘
8:	10.6x	↑
9:	9.5	↘
10:	9.9	↔
Serie		87 (1x)
Total		433 (5x)

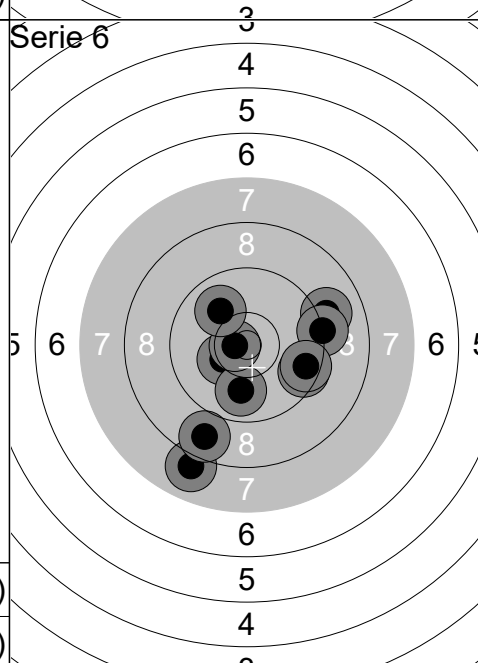

1:	8.0	↘
2:	10.3	↔
3:	9.1	→
4:	8.7	↘
5:	9.9	↓
6:	10.7x	↔
7:	10.0	↗
8:	9.6	↘
9:	9.2	→
10:	9.5	→
Serie		91 (1x)
Total		524 (6x)

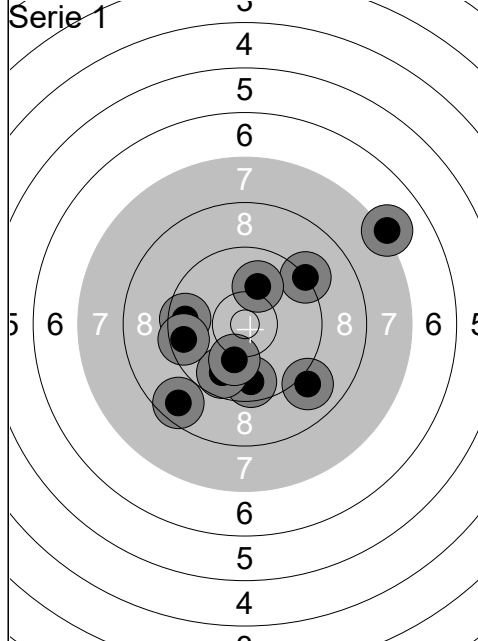

1:	9.6	←
2:	9.7	↓
3:	8.7	↙
4:	9.8	↓
5:	7.1	↗
6:	9.2	↗
7:	10.1	↑
8:	9.0	↘
9:	9.5	←
10:	10.1	↓
Serie	89 (0x)	
Total	89 (0x)	

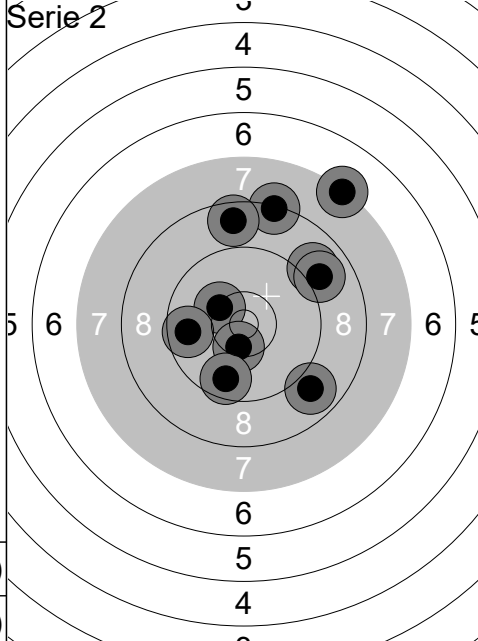

1:	10.3	↖
2:	9.0	↗
3:	8.9	↘
4:	7.3	↗
5:	8.3	↑
6:	10.4x	↓
7:	9.7	↓
8:	9.7	←
9:	8.6	↑
10:	8.9	↗
Serie	86 (1x)	
Total	175 (1x)	

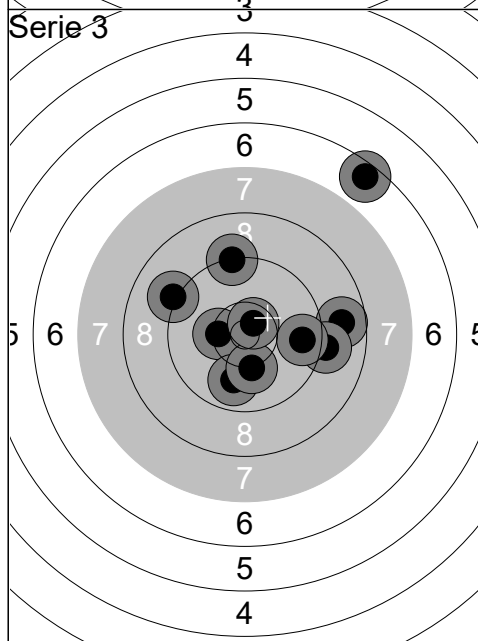

1:	6.5	↗
2:	9.3	↑
3:	10.4	←
4:	9.9	↓
5:	10.2	↓
6:	9.1	←
7:	10.6x	↗
8:	8.8	→
9:	9.1	→
10:	9.7	→
Serie	89 (1x)	
Total	264 (2x)	

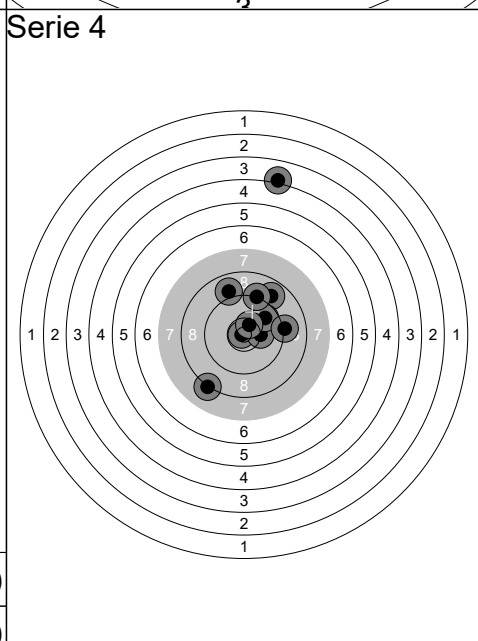

1:	10.8x	←
2:	4.1	↑
3:	8.9	↑
4:	8.9	↗
5:	10.2	→
6:	9.8	↗
7:	8.2	↙
8:	9.2	↑
9:	9.1	→
10:	10.5x	↗
Serie	85 (2x)	
Total	349 (4x)	

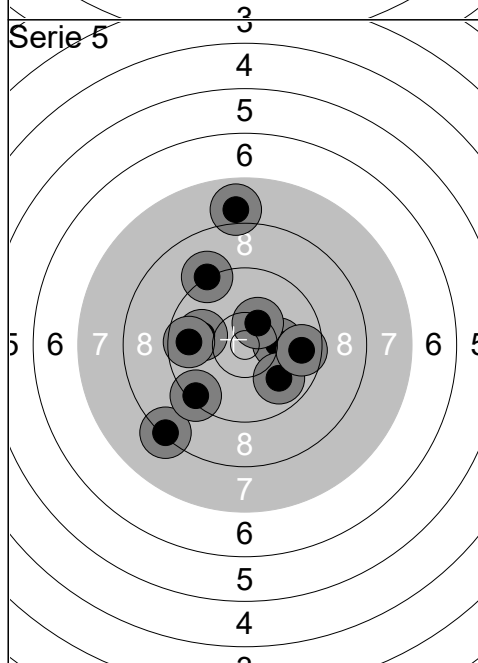

1:	10.2	→
2:	9.9	↘
3:	7.9	↑
4:	8.3	↙
5:	10.0	←
6:	9.2	↗
7:	10.4x	↗
8:	9.7	→
9:	9.4	↙
10:	9.7	←
Serie	90 (1x)	
Total	439 (5x)	

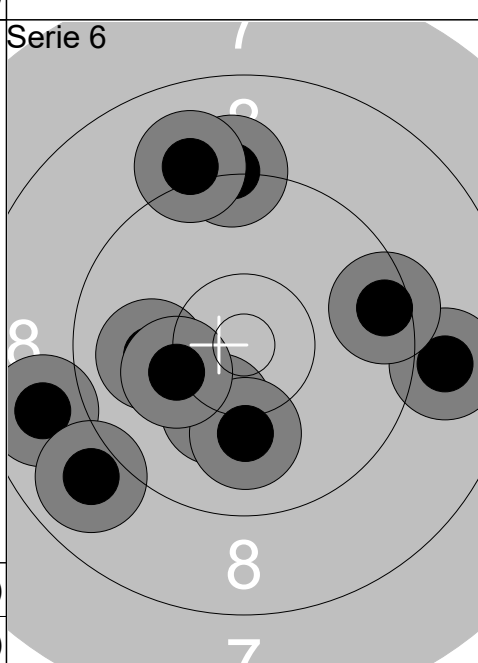

1:	10.2	↓
2:	9.2	↑
3:	8.8	←
4:	8.9	↙
5:	8.9	→
6:	9.5	→
7:	10.1	↓
8:	9.1	↑
9:	10.0	←
10:	10.2	←
Serie	91 (0x)	
Total	530 (5x)	

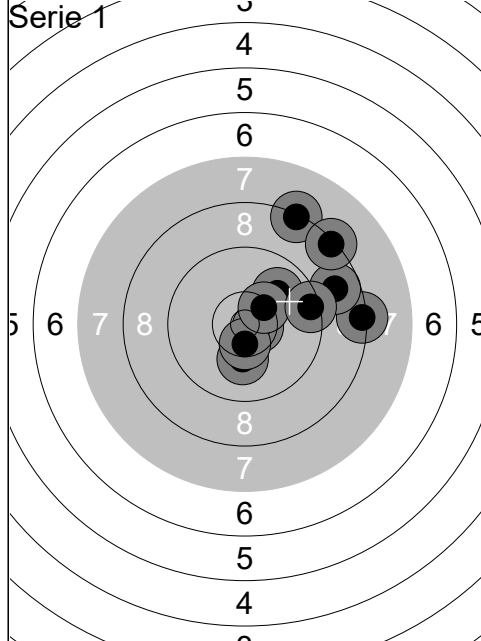

1:	10.2 ↓
2:	10.7x →
3:	8.3 →
4:	10.5x ↓
5:	9.9 ↗
6:	10.4x ↗
7:	8.8 →
8:	9.4 →
9:	8.3 ↗
10:	8.3 ↗
Serie	90 (3x)
Total	90 (3x)

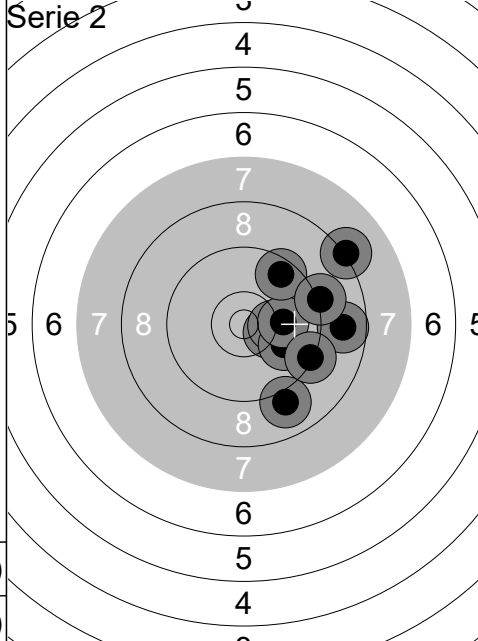

1:	8.7 →
2:	10.4 →
3:	10.3 →
4:	9.0 ↓
5:	9.9 →
6:	8.2 ↗
7:	10.1 →
8:	9.6 ↗
9:	9.3 →
10:	9.2 →
Serie	91 (0x)
Total	181 (3x)

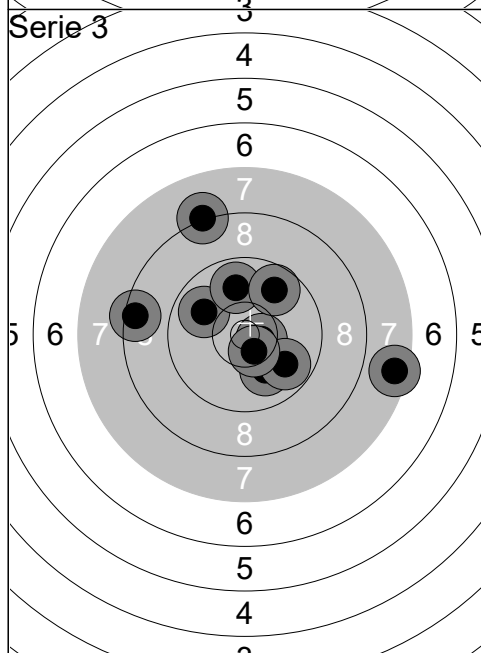

1:	9.9 ←
2:	10.6x →
3:	9.9 ↑
4:	8.2 ↗
5:	9.7 ↗
6:	7.5 →
7:	10.0 ↓
8:	8.5 ←
9:	9.8 ↓
10:	10.5x ↓
Serie	89 (2x)
Total	270 (5x)

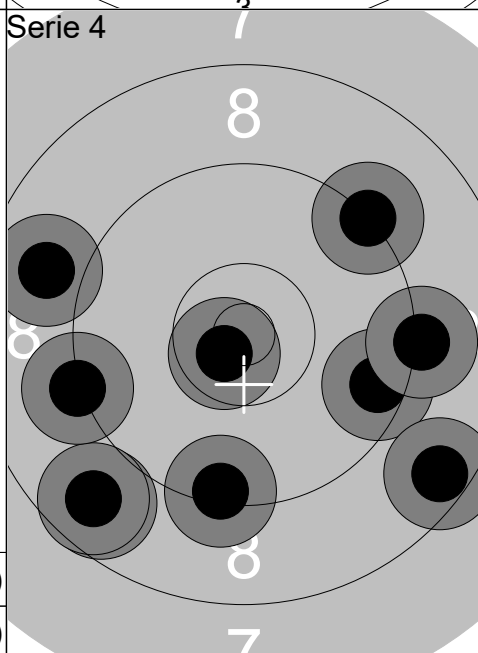

1:	8.7 ↙
2:	8.7 ↙
3:	10.7x ↙
4:	8.9 ←
5:	9.5 →
6:	9.3 ↓
7:	8.5 →
8:	9.2 ↗
9:	9.2 ←
10:	9.1 →
Serie	87 (1x)
Total	357 (6x)

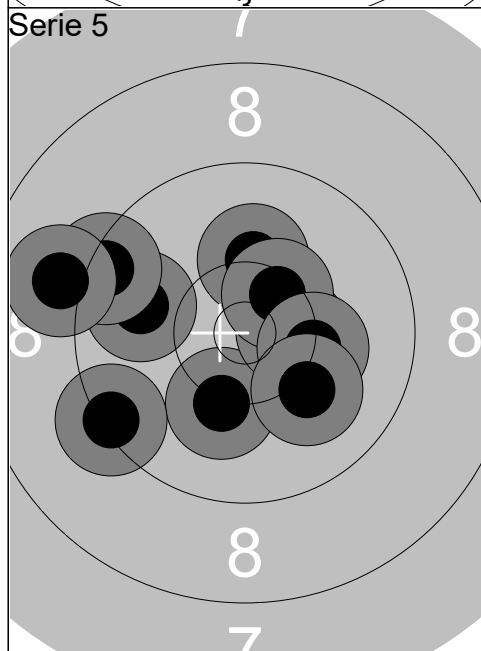

1:	10.2 ↑
2:	10.2 ↓
3:	10.5x →
4:	10.4x ↗
5:	9.3 ←
6:	9.9 ←
7:	10.2 →
8:	10.1 ↓
9:	9.4 ←
10:	9.0 ←
Serie	96 (2x)
Total	453 (8x)

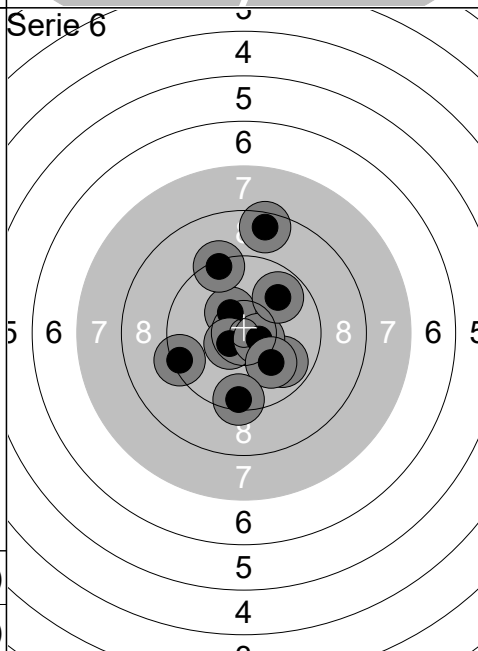

1:	8.5 ↑
2:	10.4x ↗
3:	9.4 ↑
4:	10.5x ↙
5:	9.9 →
6:	10.6x →
7:	10.1 ↓
8:	9.4 ←
9:	9.9 ↗
10:	9.5 ↓
Serie	93 (3x)
Total	546 (11x)

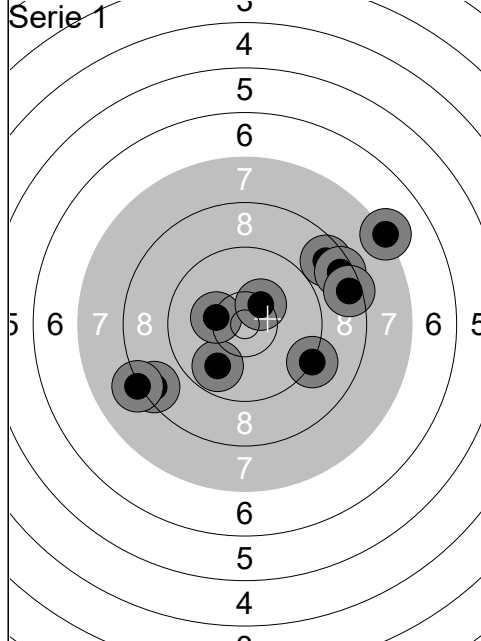

1:	8.5	↙
2:	9.8	↓
3:	8.2	↙
4:	10.3	↔
5:	8.7	↗
6:	8.5	↗
7:	9.2	↘
8:	10.4x	↗
9:	7.2	↗
10:	8.5	→
Serie		85 (1x)
Total		85 (1x)

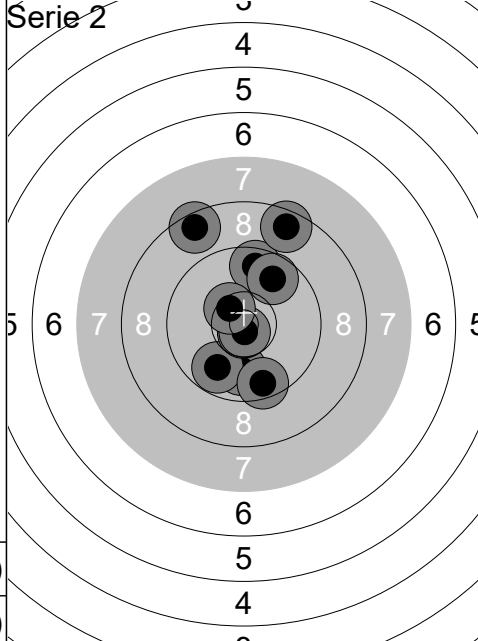

1:	9.9	↓
2:	9.6	↑
3:	8.6	↗
4:	9.7	↗
5:	9.8	↓
6:	8.5	↖
7:	9.6	↓
8:	10.8x	↓
9:	10.8x	↓
10:	10.5x	↖
Serie		91 (3x)
Total		176 (4x)

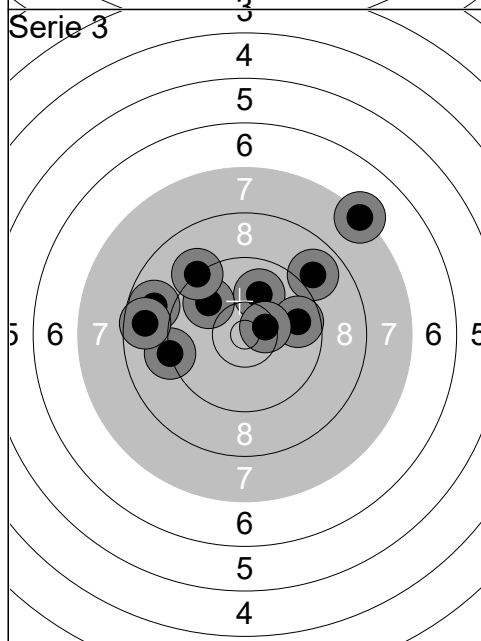

1:	10.0	↑
2:	9.9	↖
3:	9.2	↔
4:	8.9	↗
5:	8.8	↔
6:	7.3	↗
7:	9.2	↖
8:	8.7	↔
9:	9.7	→
10:	10.4x	→
Serie		87 (1x)
Total		263 (5x)

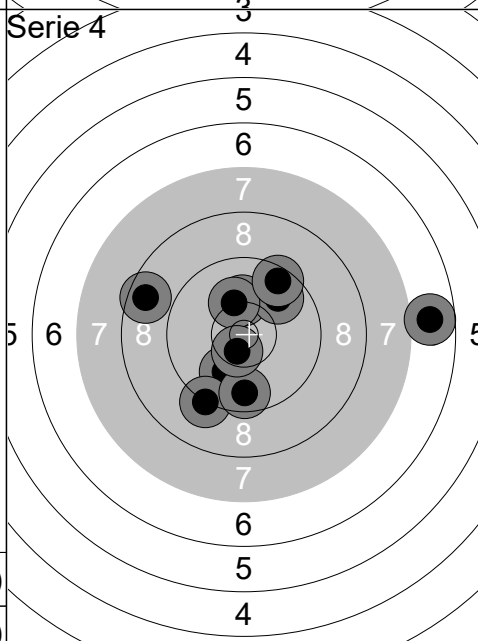

1:	10.0	↘
2:	9.2	↘
3:	10.2	↑
4:	9.7	↓
5:	9.8	↗
6:	10.2	↑
7:	9.5	↗
8:	6.8	→
9:	10.5x	↘
10:	8.6	↔
Serie		90 (1x)
Total		353 (6x)

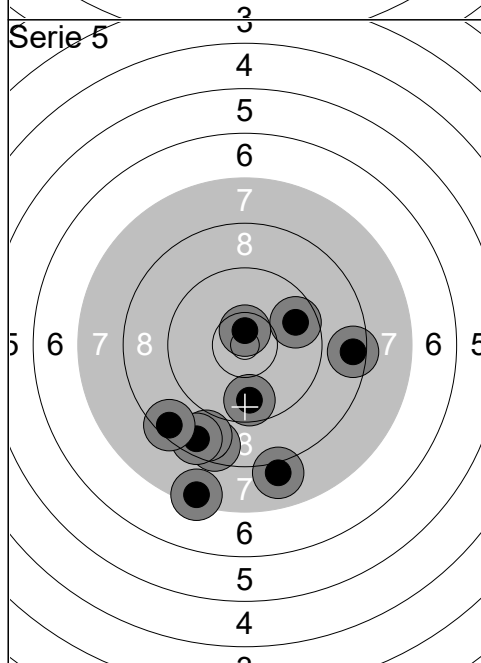

1:	8.6	↓
2:	9.7	→
3:	10.6x	↑
4:	8.0	↓
5:	9.7	↓
6:	8.7	↓
7:	7.4	↓
8:	8.6	↓
9:	8.5	→
10:	8.5	↘
Serie		83 (1x)
Total		436 (7x)

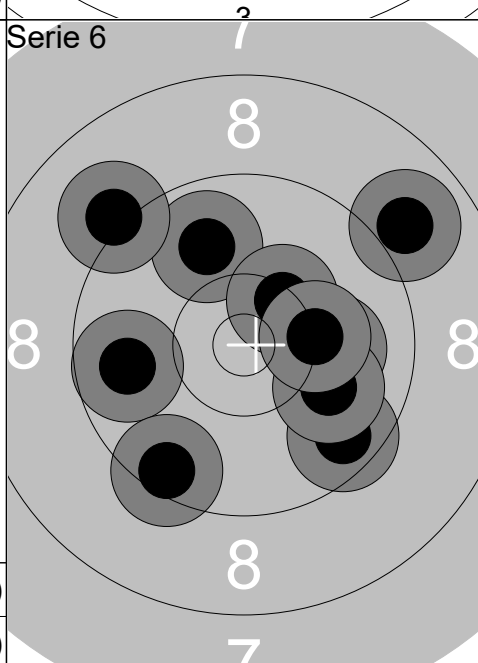

1:	9.9	↑
2:	9.6	↘
3:	9.8	↔
4:	10.1	→
5:	8.9	↗
6:	9.5	↘
7:	9.1	↖
8:	10.0	↘
9:	10.4	↗
10:	10.2	→
Serie		93 (0x)
Total		529 (7x)

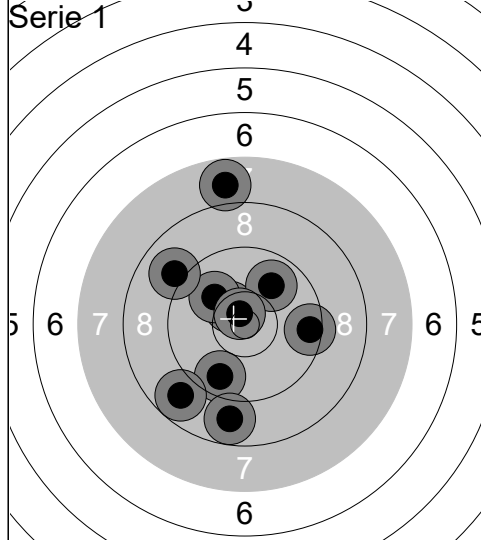

1:	9.7	↘
2:	10.4x	↖
3:	8.8	↘
4:	10.0	↖
5:	9.9	↗
6:	9.5	→
7:	7.8	↑
8:	9.0	↖
9:	10.7x	↗
10:	8.8	↘
Serie	89 (2x)	
Total	89 (2x)	

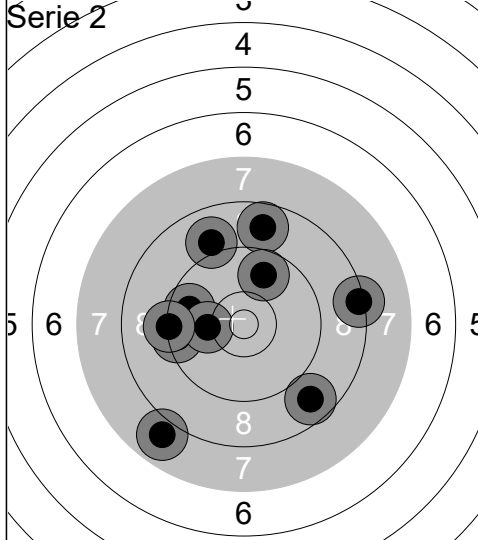

1:	9.7	←
2:	8.8	↑
3:	9.8	↗
4:	7.9	↘
5:	9.4	←
6:	10.1	←
7:	9.3	←
8:	8.7	↘
9:	9.0	↑
10:	8.3	→
Serie	86 (0x)	
Total	175 (2x)	

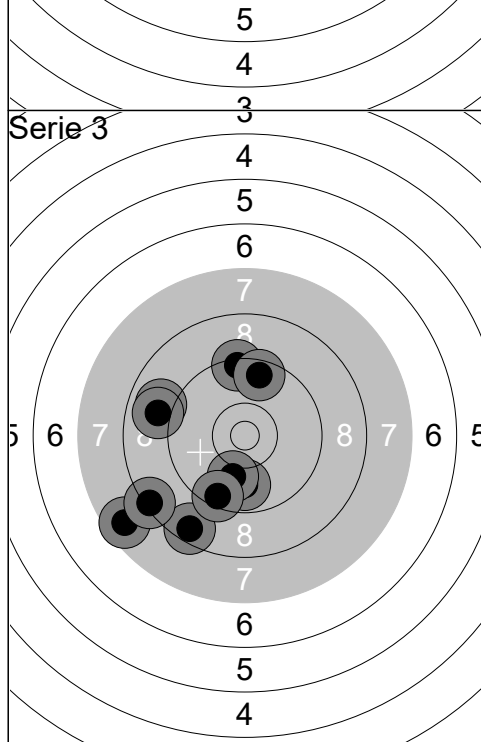

1:	7.6	←
2:	8.5	↘
3:	9.8	↘
4:	9.4	↑
5:	9.6	↑
6:	8.9	←
7:	8.9	←
8:	10.0	↘
9:	8.3	←
10:	9.5	↘
Serie	85 (0x)	
Total	260 (2x)	

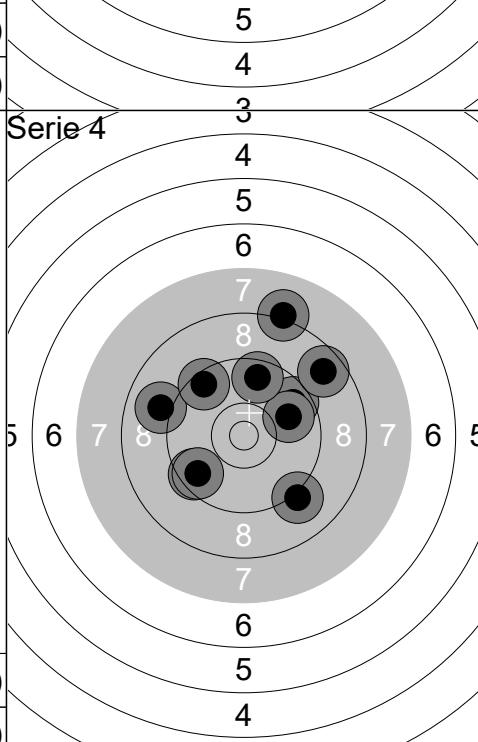

1:	9.6	↗
2:	9.5	↘
3:	9.1	↘
4:	8.1	↑
5:	9.6	↘
6:	9.9	→
7:	9.0	←
8:	9.5	↖
9:	8.7	↗
10:	9.6	↑
Serie	88 (0x)	
Total	348 (2x)	

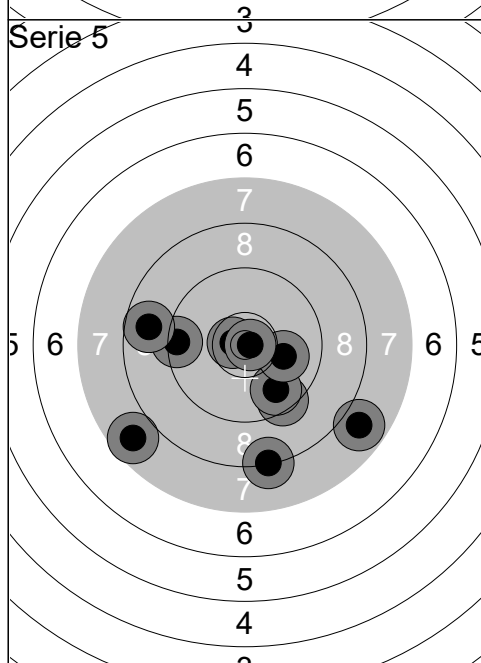

1:	9.5	↘
2:	9.7	↘
3:	9.4	←
4:	10.0	→
5:	7.7	↘
6:	10.7x	←
7:	10.8x	→
8:	8.3	↘
9:	7.8	↘
10:	8.8	←
Serie	87 (2x)	
Total	435 (4x)	

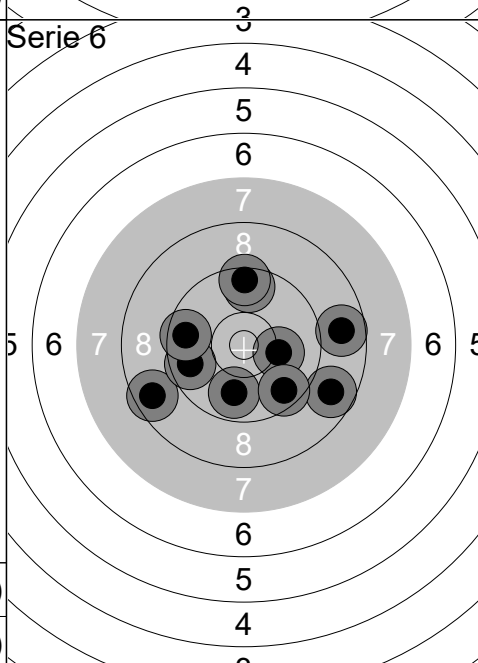

1:	8.7	↘
2:	9.9	↘
3:	10.2	→
4:	8.8	→
5:	8.6	↘
6:	9.6	↑
7:	9.5	↑
8:	9.6	↘
9:	9.7	←
10:	9.6	←
Serie	88 (0x)	
Total	523 (4x)	

10 m seniorer

Ljusdals Pistolskytteklubb

H 2

25.03.2023

SM & JSM 10 m pistol

Umeå skytteallians

Serie 1

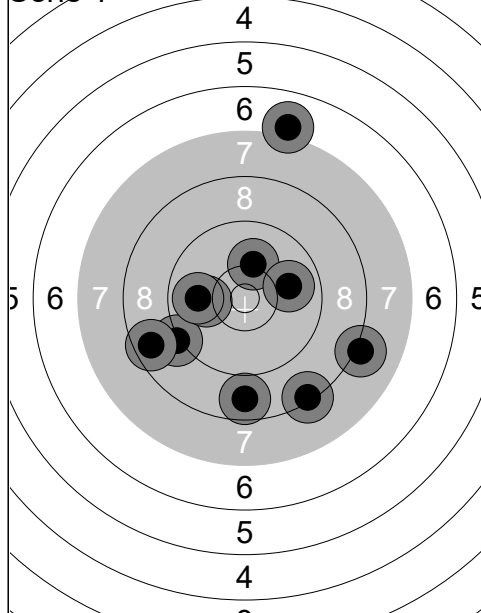

1: 7.0 ↗
 2: 9.2 ↙
 3: 8.3 ↘
 4: 10.2 ↗
 5: 10.1 ←
 6: 8.6 ←
 7: 8.1 →
 8: 9.9 →
 9: 8.7 ↓
 10: 9.9 ←

Serie 86 (0x)

Total 86 (0x)

Serie 2

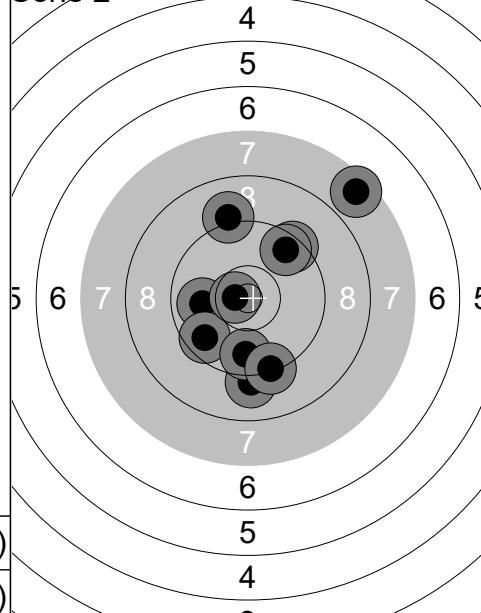

1: 9.4 ↗
 2: 9.9 ←
 3: 9.1 ↓
 4: 9.6 ↙
 5: 9.6 ↗
 6: 9.1 ↑
 7: 10.7x ←
 8: 9.7 ↓
 9: 7.6 ↗
 10: 9.3 ↓

Serie 89 (1x)

Total 175 (1x)

Serie 3

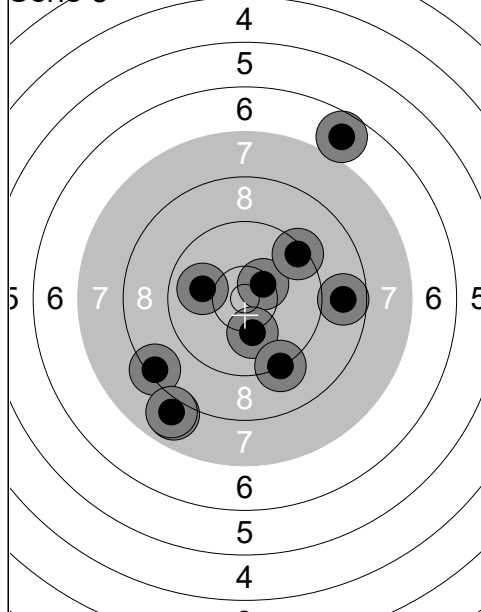

1: 10.4x ↗
 2: 8.4 ↙
 3: 7.9 ↘
 4: 10.2 ↘
 5: 10.0 ←
 6: 6.7 ↗
 7: 9.2 ↘
 8: 9.4 ↗
 9: 7.9 ↘
 10: 8.8 →

Serie 84 (1x)

Total 259 (2x)

Serie 4

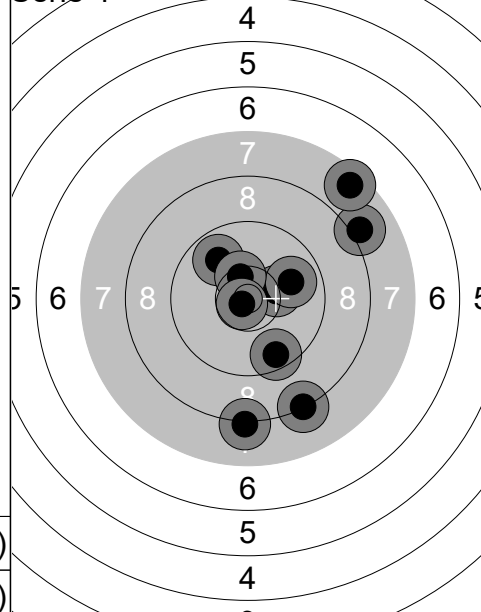

1: 9.9 ↖
 2: 8.2 ↘
 3: 10.3 →
 4: 8.0 ↗
 5: 9.9 →
 6: 10.4x ↗
 7: 9.5 ↘
 8: 7.5 ↗
 9: 10.8x ↙
 10: 8.1 ↓

Serie 88 (2x)

Total 347 (4x)

Serie 5

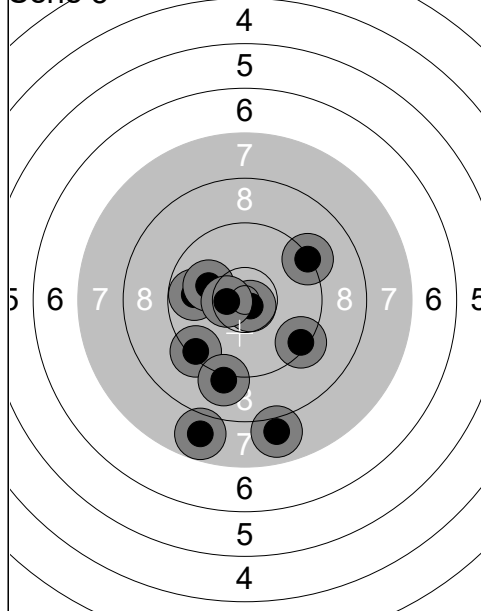

1: 9.4 ↘
 2: 9.8 ←
 3: 7.8 ↘
 4: 10.1 ←
 5: 7.9 ↘
 6: 9.3 ↗
 7: 9.4 ↙
 8: 9.1 ↘
 9: 10.8x ↘
 10: 10.5x ←

Serie 89 (2x)

Total 436 (6x)

Serie 6

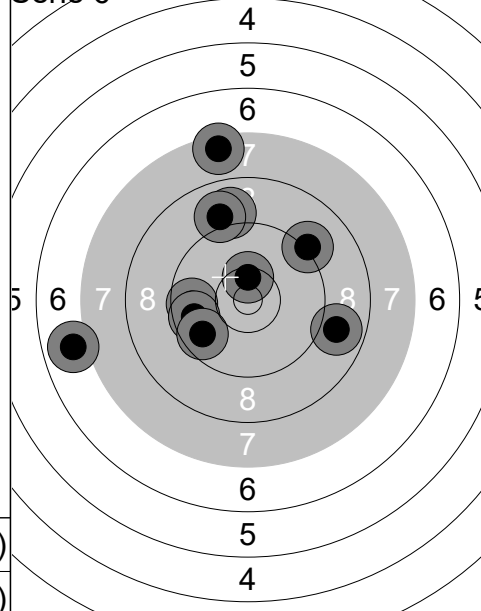

1: 7.5 ↗
 2: 9.0 ↗
 3: 9.7 ←
 4: 9.7 ←
 5: 9.2 ↗
 6: 9.7 ↙
 7: 9.0 ↑
 8: 8.9 →
 9: 10.5x ↑
 10: 6.9 ←

Serie 85 (1x)

Total 521 (7x)

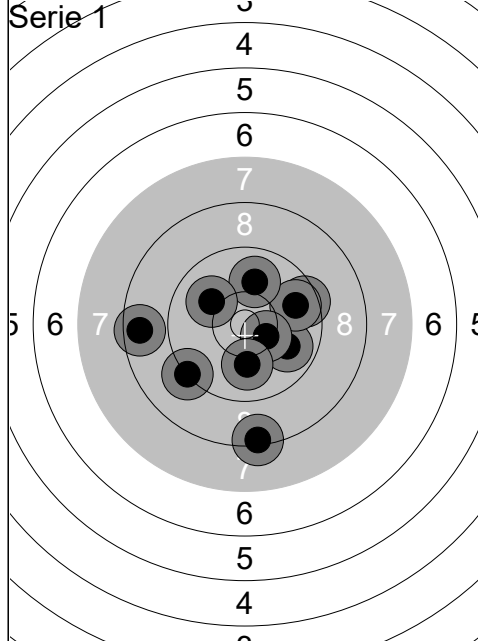

1:	9.9	↘
2:	9.5	→
3:	8.6	←
4:	9.2	↙
5:	8.4	↓
6:	9.7	→
7:	10.4x	↘
8:	10.0	↓
9:	10.0	↑
10:	10.0	↖
Serie		92 (1x)
Total		92 (1x)

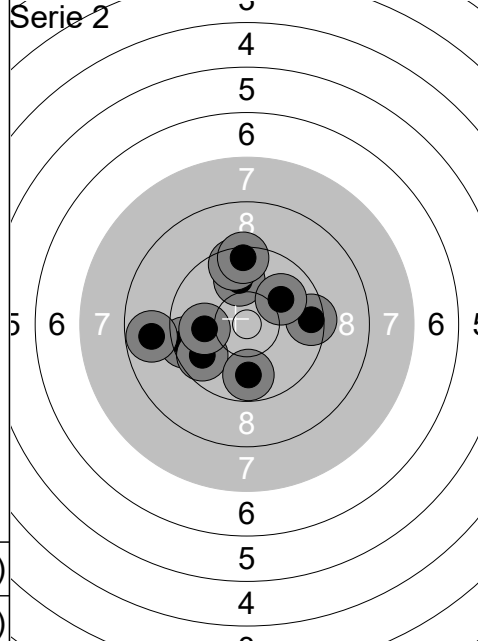

1:	10.0	↑
2:	9.5	→
3:	9.6	↑
4:	9.5	←
5:	10.0	↗
6:	9.5	↑
7:	9.7	↙
8:	10.0	←
9:	9.8	↓
10:	8.8	←
Serie		92 (0x)
Total		184 (1x)

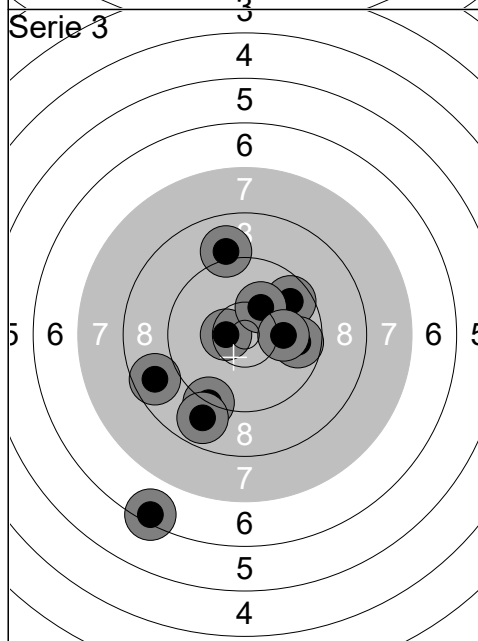

1:	9.7	↗
2:	9.2	↙
3:	10.5x	←
4:	9.8	→
5:	8.9	↙
6:	10.2	↗
7:	8.7	←
8:	6.4	↙
9:	10.1	→
10:	9.0	↑
Serie		88 (1x)
Total		272 (2x)

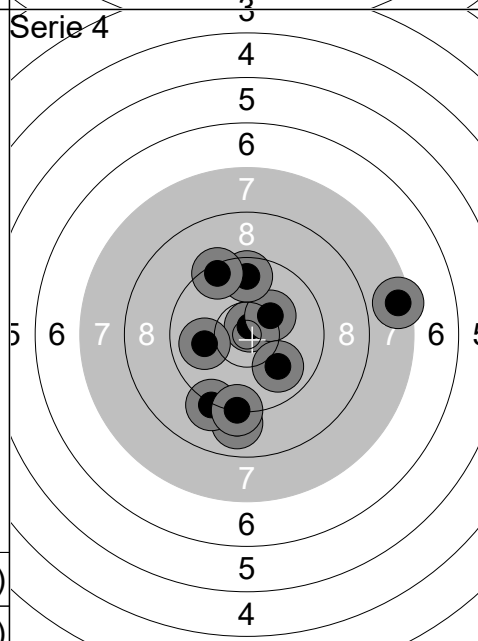

1:	10.7x	↑
2:	9.0	↓
3:	10.3	↗
4:	10.0	↘
5:	10.0	←
6:	7.5	→
7:	9.2	↙
8:	9.7	↑
9:	9.4	↖
10:	9.2	↓
Serie		92 (1x)
Total		364 (3x)

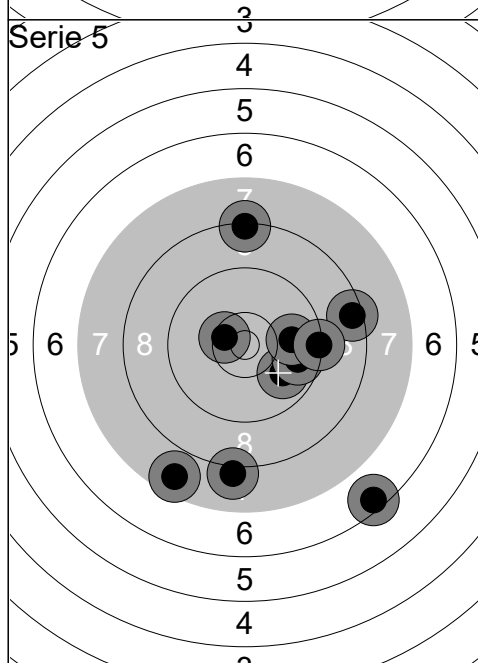

1:	9.9	↘
2:	7.6	↙
3:	9.7	→
4:	6.5	↙
5:	8.5	→
6:	9.9	→
7:	8.3	↑
8:	10.5x	↖
9:	8.1	↓
10:	9.3	→
Serie		83 (1x)
Total		447 (4x)

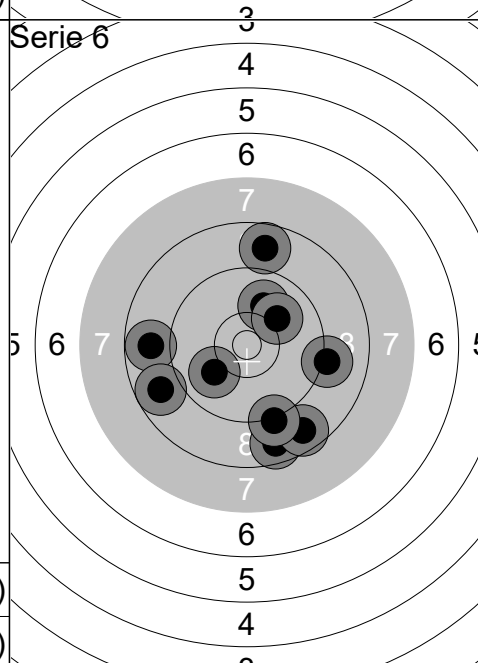

1:	8.7	↓
2:	8.7	↘
3:	10.0	↙
4:	8.8	↑
5:	9.1	→
6:	8.8	←
7:	8.8	↙
8:	10.0	↗
9:	10.0	↗
10:	9.2	↓
Serie		88 (0x)
Total		535 (4x)

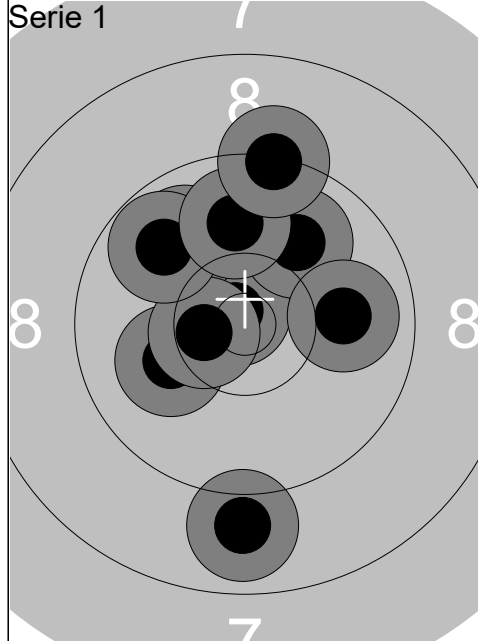

1:	10.8x ↗
2:	10.1 ←
3:	9.9 ↗
4:	10.5x ←
5:	9.8 ↗
6:	10.0 ↗
7:	9.9 ↑
8:	9.9 →
9:	8.9 ↓
10:	9.3 ↑
Serie	93 (2x)
Total	93 (2x)

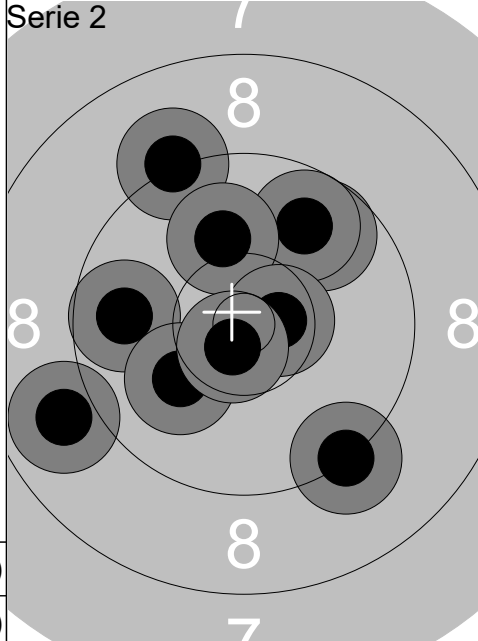

1:	9.8 ↗
2:	9.2 ↗
3:	9.8 ↗
4:	10.1 ↑
5:	9.2 ↓
6:	9.7 ←
7:	10.1 ↙
8:	8.9 ←
9:	10.6x →
10:	10.7x ↓
Serie	93 (2x)
Total	186 (4x)

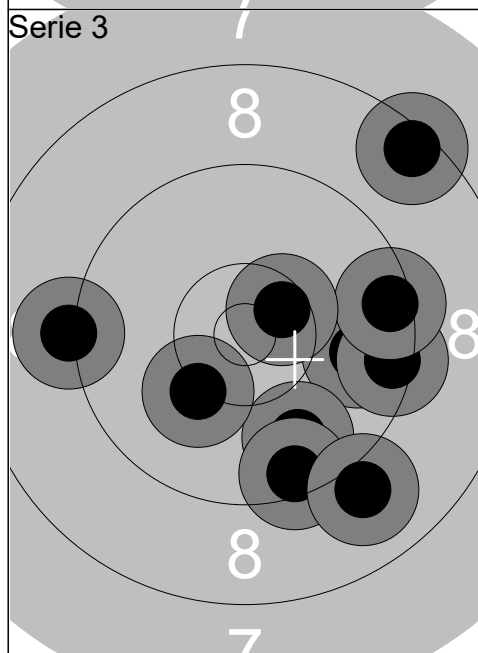

1:	9.2 ←
2:	9.8 →
3:	9.4 →
4:	9.8 ↓
5:	9.5 ↓
6:	9.5 →
7:	10.5x ↗
8:	9.0 ↓
9:	10.2 ↙
10:	8.4 ↗
Serie	91 (1x)
Total	277 (5x)

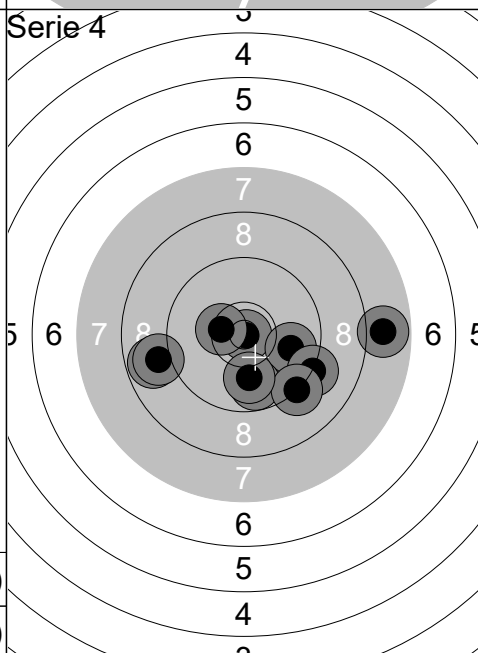

1:	8.8 ←
2:	10.9x →
3:	9.9 →
4:	9.2 ↘
5:	9.8 ↓
6:	10.4x ←
7:	9.2 ↓
8:	7.8 →
9:	9.0 ←
10:	10.0 ↓
Serie	90 (2x)
Total	367 (7x)

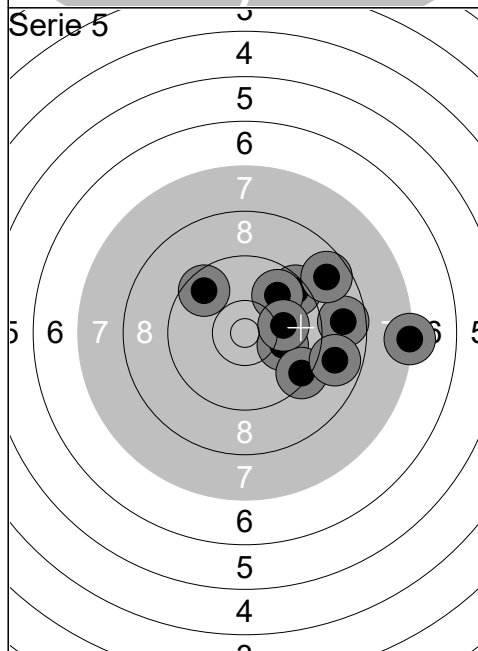

1:	9.6 ↗
2:	9.5 ↗
3:	8.7 →
4:	7.3 →
5:	8.7 ↗
6:	9.8 ↗
7:	10.1 →
8:	9.4 ↓
9:	8.8 →
10:	10.1 →
Serie	87 (0x)
Total	454 (7x)

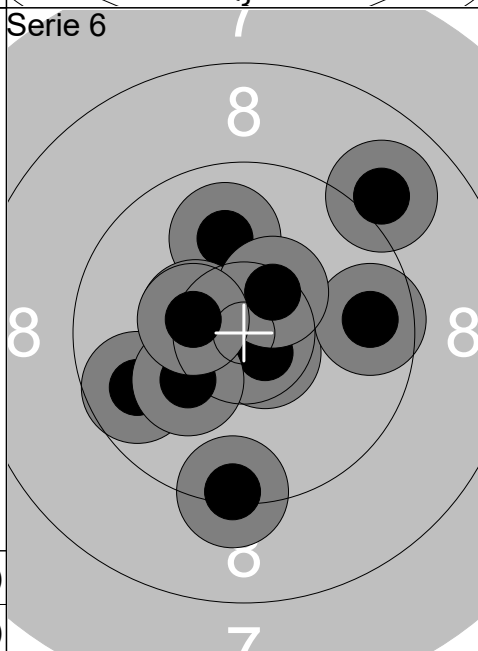

1:	9.3 ↓
2:	10.0 ↑
3:	10.7x ↘
4:	9.0 ↗
5:	9.7 ←
6:	9.7 →
7:	10.2 ↙
8:	10.4x ←
9:	10.4x ↗
10:	10.4x ←
Serie	96 (4x)
Total	550 (11x)

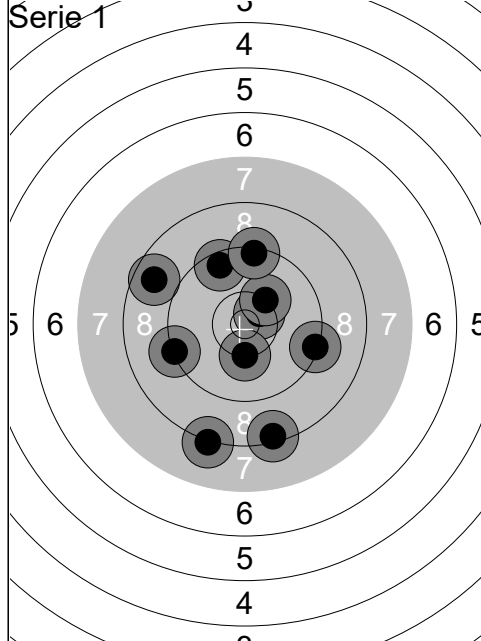

1:	10.5x ↗
2:	8.4 ↓
3:	8.2 ↓
4:	8.7 ↖
5:	9.3 ←
6:	10.3 ↓
7:	9.5 ↑
8:	10.2 ↗
9:	9.3 →
10:	9.3 ↑
Serie	90 (1x)
Total	90 (1x)

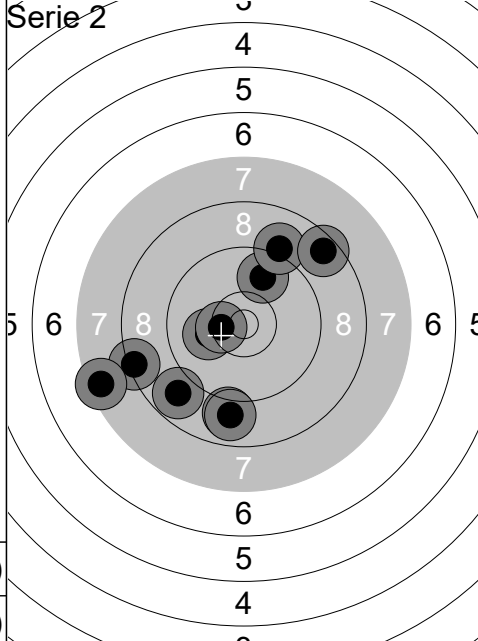

1:	8.3 ←
2:	9.8 ↑
3:	9.1 ↗
4:	9.0 ↓
5:	8.9 ↓
6:	10.1 ←
7:	8.8 ↖
8:	8.5 ↗
9:	7.5 ←
10:	10.4x ←
Serie	86 (1x)
Total	176 (2x)

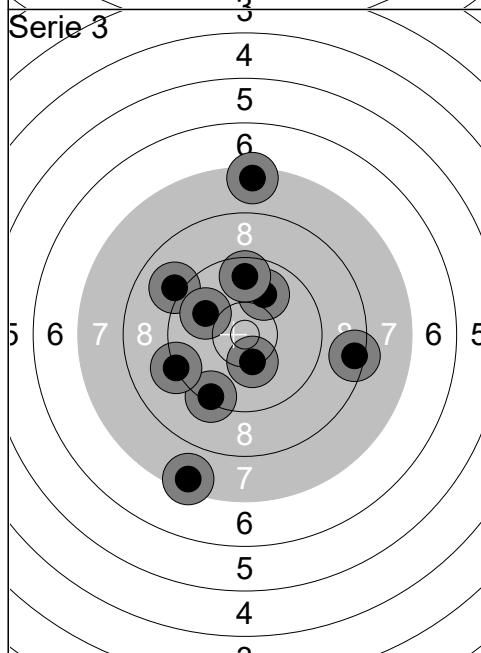

1:	7.5 ↓
2:	7.5 ↑
3:	9.4 ↓
4:	9.1 ↖
5:	10.3 ↓
6:	9.9 ↖
7:	10.0 ↗
8:	9.2 ←
9:	8.4 →
10:	9.6 ↑
Serie	87 (0x)
Total	263 (2x)

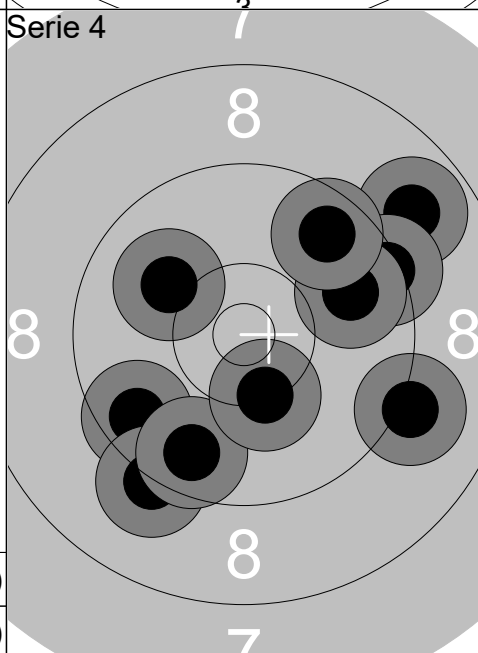

1:	8.9 ↗
2:	10.0 ↖
3:	9.6 ↖
4:	9.4 →
5:	9.1 →
6:	9.8 →
7:	9.2 ↓
8:	9.6 ↓
9:	9.6 ↗
10:	10.3 ↓
Serie	91 (0x)
Total	354 (2x)

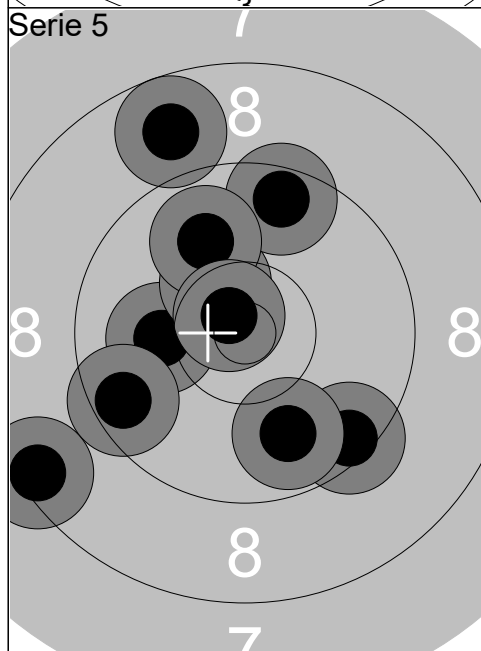

1:	8.8 ↑
2:	10.1 ←
3:	10.4x ↗
4:	9.5 ↑
5:	8.4 ←
6:	9.5 ↓
7:	9.8 ↓
8:	9.5 ←
9:	9.9 ↑
10:	10.7x ↗
Serie	91 (2x)
Total	445 (4x)

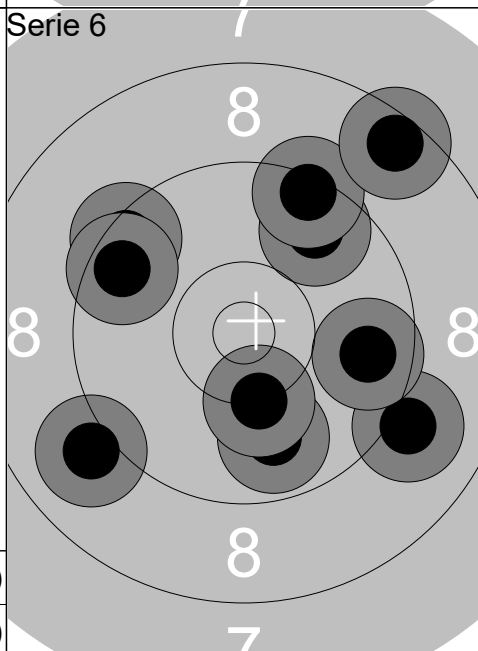

1:	9.7 ↗
2:	9.0 →
3:	9.4 ↗
4:	9.4 ↖
5:	9.9 ↓
6:	8.5 ↗
7:	9.7 →
8:	10.2 ↓
9:	9.6 ↖
10:	9.0 ↖
Serie	90 (0x)
Total	535 (4x)

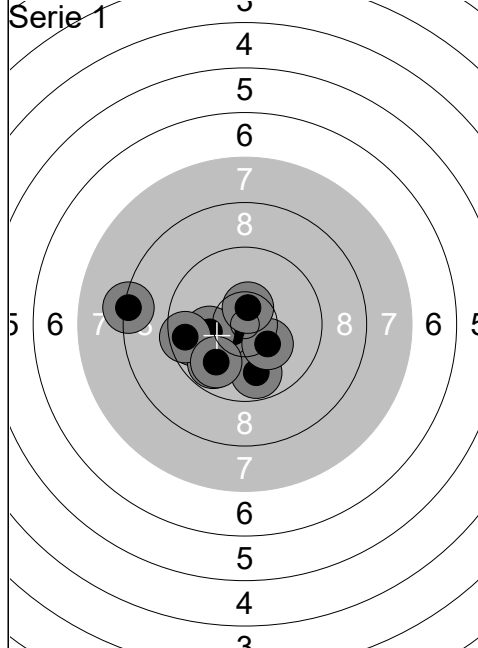

1:	10.6x ↙
2:	9.7 ←
3:	9.8 ↘
4:	10.1 ←
5:	9.6 ←
6:	8.3 ←
7:	9.8 ↘
8:	9.9 ↘
9:	10.3 ↘
10:	10.6x ↑
Serie	93 (2x)
Total	93 (2x)

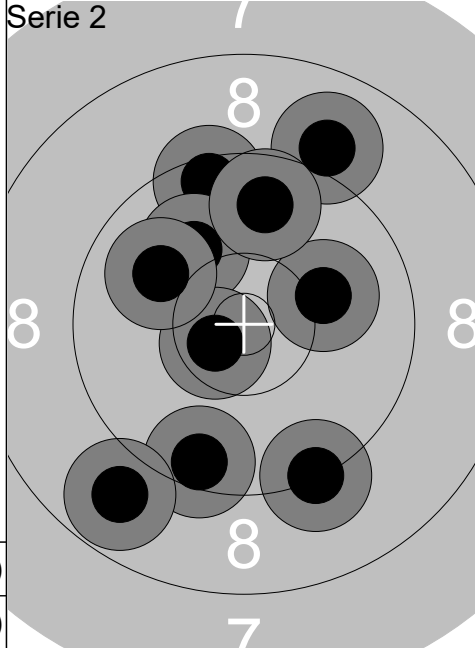

1:	9.5 ↑
2:	10.1 →
3:	10.0 ↖
4:	9.0 ↑
5:	9.3 ↘
6:	9.5 ↘
7:	9.7 ↑
8:	8.8 ↘
9:	10.6x ↙
10:	10.0 ↖
Serie	93 (1x)
Total	186 (3x)

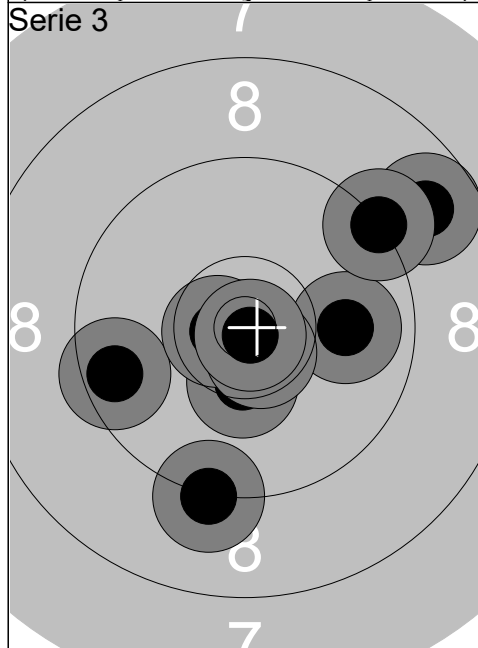

1:	9.6 ←
2:	8.8 ↗
3:	10.8x ↘
4:	10.4x ↘
5:	9.9 →
6:	10.7x ←
7:	10.6x ↘
8:	10.9x ↘
9:	9.2 ↗
10:	9.2 ↘
Serie	94 (5x)
Total	280 (8x)

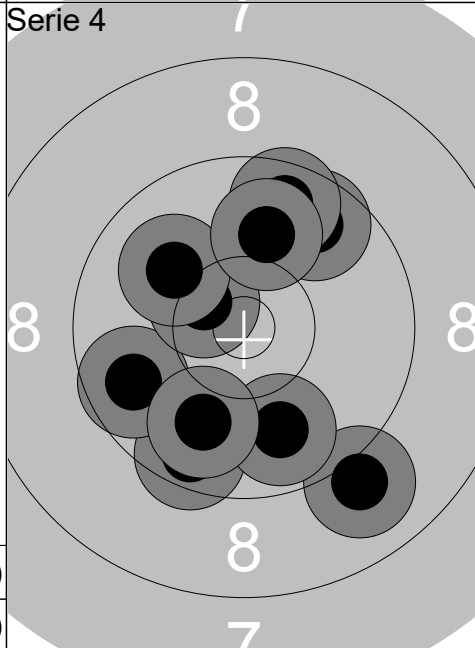

1:	9.7 ↗
2:	9.6 ↘
3:	9.6 ↑
4:	9.0 ↘
5:	9.7 ↖
6:	9.9 ↘
7:	10.5x ↖
8:	10.0 ↖
9:	10.0 ↑
10:	9.9 ↘
Serie	93 (1x)
Total	373 (9x)

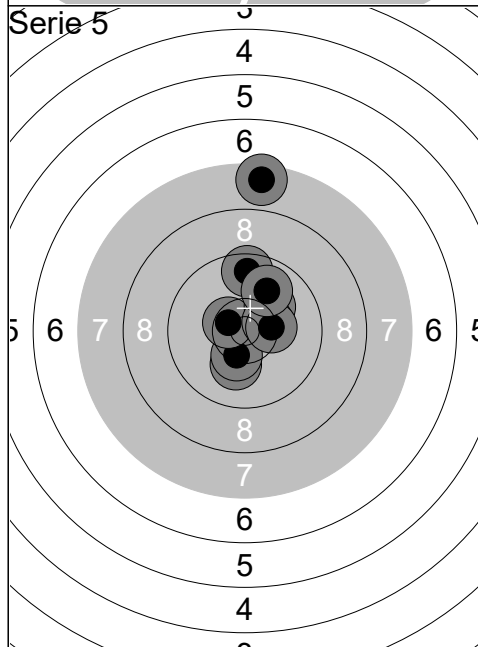

1:	9.6 ↑
2:	10.2 ↘
3:	7.5 ↑
4:	10.4x ↘
5:	10.3 ↗
6:	10.5x ↖
7:	10.2 ↗
8:	10.4x →
9:	10.3 →
10:	9.9 ↑
Serie	95 (3x)
Total	468 (12x)

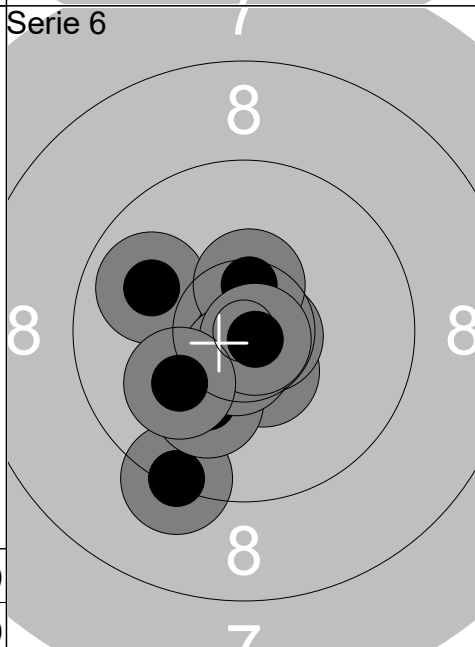

1:	10.4x ↖
2:	9.9 ↖
3:	10.5x ↘
4:	9.3 ↘
5:	10.7x →
6:	10.5x ↑
7:	10.1 ↘
8:	10.6x ↘
9:	10.8x ↘
10:	10.1 ↖
Serie	98 (6x)
Total	566 (18x)