

Serie 2

1:	8.8	⬇
2:	9.3	↖
3:	9.4	⬅
4:	7.7	⬇
5:	8.9	↗
6:	10.2	⬆
7:	9.0	➔
8:	8.9	⬆
9:	10.4x	↗
10:	10.7x	⬆
Serie		88 (2x)
Total		173 (2x)

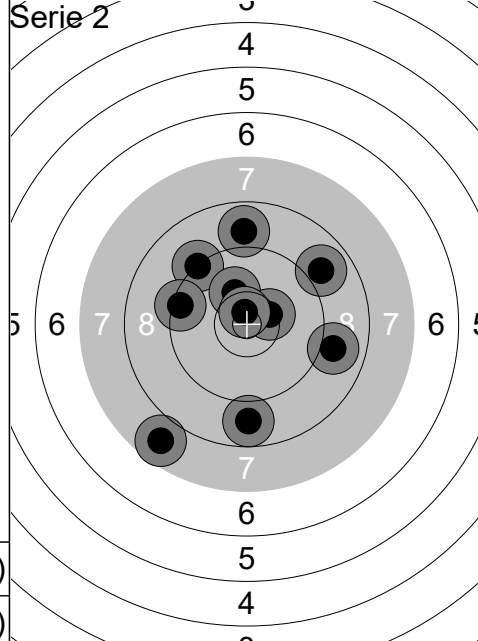

Serie 4

1:	8.8	⬇
2:	10.3	↗
3:	9.0	⬆
4:	10.4x	⬆
5:	10.7x	➔
6:	10.1	⬇
7:	10.0	⬅
8:	9.2	↗
9:	7.4	↗
10:	10.0	↗
Serie		93 (2x)
Total		351 (4x)

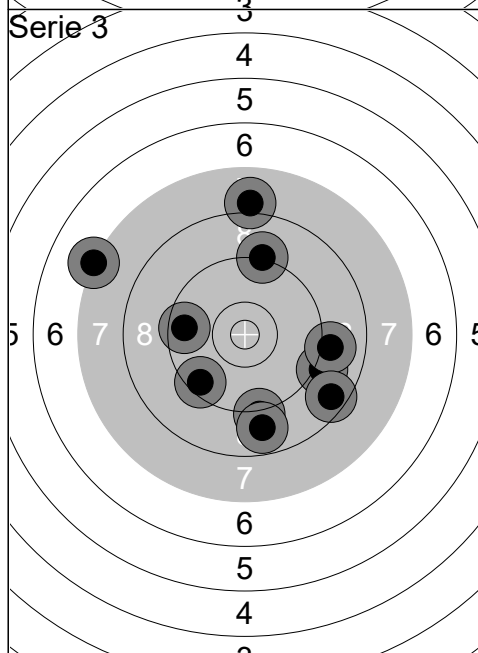

Serie 6

1:	8.7	⬆
2:	7.4	⬆
3:	9.5	⬅
4:	9.7	⬇
5:	9.2	➔
6:	8.6	➔
7:	9.5	⬅
8:	9.8	⬆
9:	9.3	⬇
10:	10.6x	⬇
Serie		87 (1x)
Total		525 (6x)

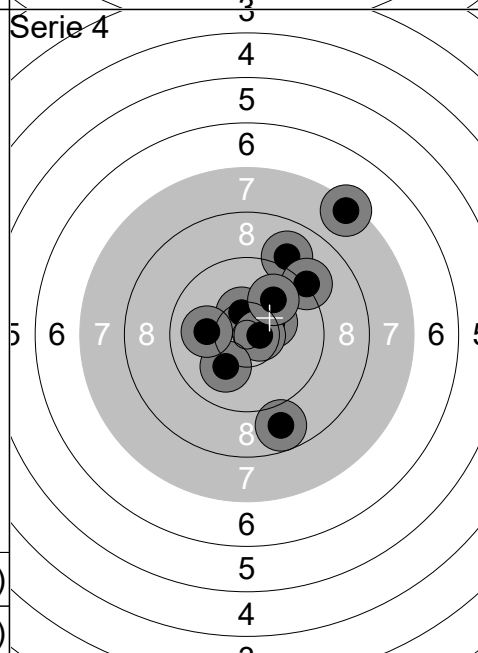

Serie 6

1:	8.7	⬆
2:	7.4	⬆
3:	9.5	⬅
4:	9.7	⬇
5:	9.2	➔
6:	8.6	➔
7:	9.5	⬅
8:	9.8	⬆
9:	9.3	⬇
10:	10.6x	⬇
Serie		87 (1x)
Total		525 (6x)

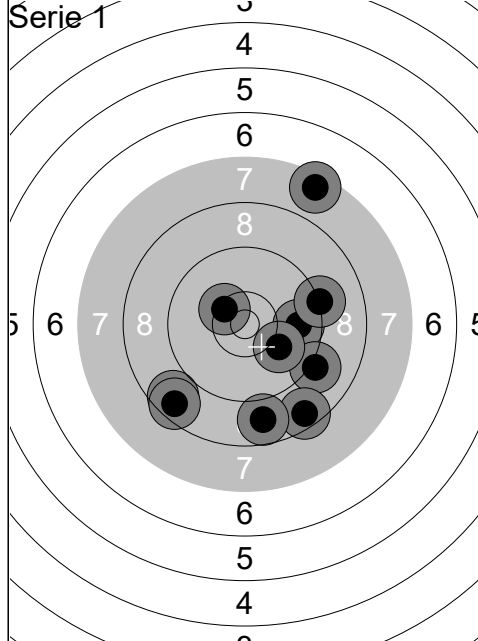

1:	7.5	↗
2:	8.7	↙
3:	10.4x	↖
4:	9.7	→
5:	9.1	↘
6:	10.0	↘
7:	9.2	→
8:	8.6	↙
9:	8.6	↘
10:	8.8	↘
Serie	86	(1x)
Total	86	(1x)

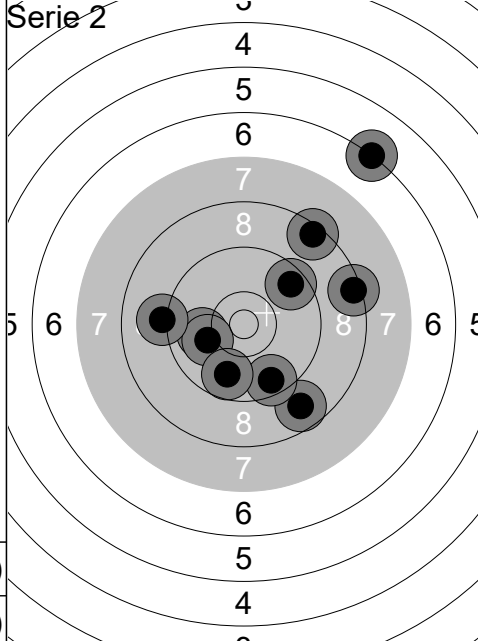

1:	10.0	←
2:	6.2	↗
3:	10.1	←
4:	8.7	↘
5:	8.4	→
6:	9.6	↗
7:	8.4	↗
8:	9.6	↘
9:	9.8	↘
10:	9.1	←
Serie	86	(0x)
Total	172	(1x)

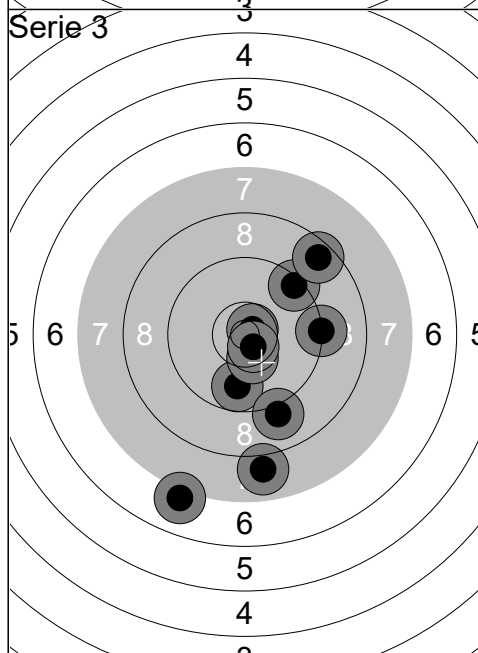

1:	7.0	↘
2:	10.7x	↗
3:	9.4	↗
4:	9.8	↘
5:	8.6	↗
6:	9.0	↘
7:	10.4x	↘
8:	7.9	↘
9:	10.6x	↘
10:	9.2	→
Serie	88	(3x)
Total	260	(4x)

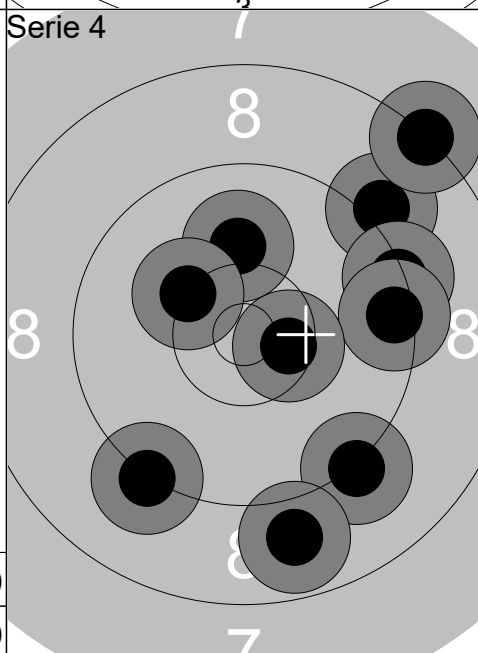

1:	9.1	↗
2:	9.3	→
3:	8.2	↗
4:	9.4	→
5:	9.2	↘
6:	8.8	↘
7:	10.1	↑
8:	10.2	↖
9:	9.2	↘
10:	10.5x	→
Serie	91	(1x)
Total	351	(5x)

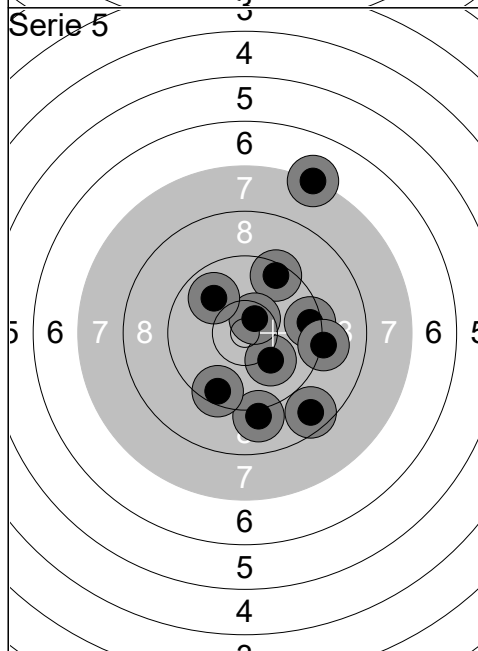

1:	9.5	→
2:	9.1	↘
3:	9.5	↗
4:	7.2	↗
5:	10.1	↘
6:	9.5	↘
7:	10.5x	↗
8:	8.6	↘
9:	9.2	→
10:	9.9	↖
Serie	89	(1x)
Total	440	(6x)

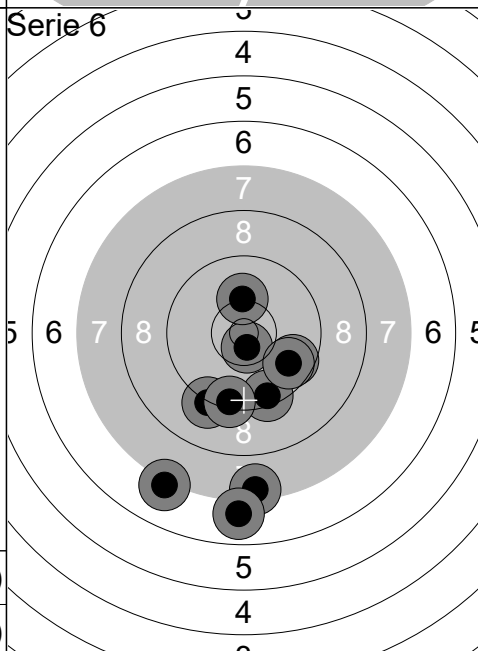

1:	10.6x	↘
2:	7.5	↘
3:	9.7	↘
4:	9.4	↘
5:	10.2	↑
6:	9.2	↘
7:	9.4	↘
8:	7.1	↘
9:	6.9	↘
10:	9.7	↘
Serie	85	(1x)
Total	525	(7x)

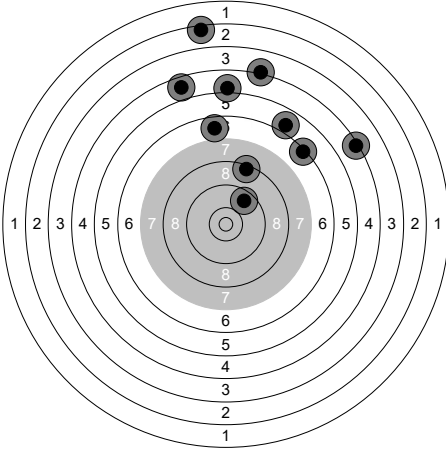
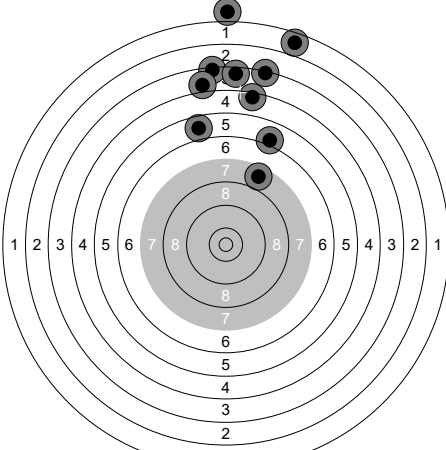
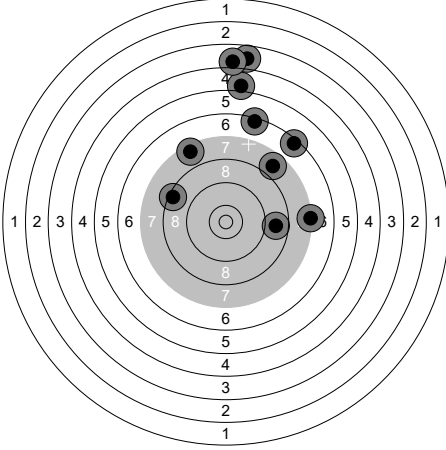
Skjutlag	Tavla	Ilayda Tatli	
10 m juniorer		Dorotea Pistolskytteklubb	DJ Ä
25.03.2023		SM & JSM 10 m pistol	Umeå skytteallians
Serie 1		1: 4.3 ↗ 2: 5.9 ↗ 3: 6.7 ↑ 4: 5.0 ↑ 5: 9.7 ↗ 6: 8.4 ↗ 7: 6.3 ↗ 8: 2.4 ↑ 9: 4.7 ↗ 10: 4.2 ↑	Serie 2
		1: 2.7 ↑ 2: 0.0 ↑ 3: 8.4 ↗ 4: 6.7 ↑ 5: 6.8 ↗ 6: 6.2 ↑ 7: 6.5 ↗ 8: 7.1 ↗ 9: 2.5 ↑ 10: 4.5 ↑	
		Serie 53 (0x)	Serie 47 (0x)
		Total 53 (0x)	Total 100 (0x)
Serie 3		1: 3.3 ↑ 2: 6.0 ↗ 3: 3.9 ↑ 4: 4.4 ↑ 5: 5.7 ↑ 6: 0.0 ↑ 7: 7.6 ↗ 8: 3.3 ↑ 9: 3.5 ↑ 10: 1.6 ↗	Serie 4
		1: 0.0 ↗ 2: 4.4 ↑ 3: 7.9 ↑ 4: 8.1 ↑ 5: 8.9 ↑ 6: 5.6 ↗ 7: 6.4 ↗ 8: 7.5 ↗ 9: 2.6 ↑ 10: 7.0 ↗	
		Serie 35 (0x)	Serie 54 (0x)
		Total 135 (0x)	Total 189 (0x)
Serie 5		1: 6.4 ↗ 2: 7.5 ↗ 3: 8.8 → 4: 6.4 ↑ 5: 5.0 ↑ 6: 7.2 → 7: 3.8 ↑ 8: 4.0 ↑ 9: 7.8 ↗ 10: 8.4 ↗	Serie 6
		1: 7.5 ↑ 2: 5.1 ↑ 3: 4.5 ↗ 4: 7.5 ↗ 5: 7.2 ↗ 6: 6.9 ↑ 7: 8.4 → 8: 8.4 ↑ 9: 5.8 ↗ 10: 9.5 ↗	
		Serie 61 (0x)	Serie 66 (0x)
		Total 250 (0x)	Total 316 (0x)

Skjutlag 1	Tavla 24	Alva Öström	
10 m juniorer		Luleå Sportskytteklubb	DJ Ä
25.03.2023		SM & JSM 10 m pistol	Umeå skytteallians
Serie 1		1: 9.7 ↓ 2: 8.5 ← 3: 7.8 ↑ 4: 10.8x ↘ 5: 10.0 ↓ 6: 10.3 ↑ 7: 10.7x ← 8: 6.6 ↗ 9: 8.0 ↑ 10: 9.4 ↑	Serie 2
		Serie 87 (2x) Total 87 (2x)	1: 9.1 ← 2: 8.5 ↓ 3: 9.6 ↑ 4: 10.1 ← 5: 8.9 ← 6: 9.5 ↑ 7: 9.6 ↘ 8: 9.7 ↓ 9: 10.4x → 10: 7.9 ↗
Serie 3		1: 9.7 ↑ 2: 8.8 ↓ 3: 9.5 ↗ 4: 10.8x ↘ 5: 8.3 ↗ 6: 10.1 ↑ 7: 10.2 ↑ 8: 8.7 ↑ 9: 9.8 ↓ 10: 7.9 ←	Serie 4
		Serie 88 (1x) Total 263 (4x)	1: 9.0 ← 2: 8.9 → 3: 9.8 ← 4: 10.1 ← 5: 9.2 ← 6: 9.2 → 7: 9.0 ← 8: 8.7 ↓ 9: 8.5 ← 10: 7.5 ↘
Serie 5		1: 10.3 → 2: 8.9 ↘ 3: 10.0 ← 4: 9.1 ↓ 5: 9.1 ↑ 6: 9.7 → 7: 9.8 ↑ 8: 10.7x → 9: 10.0 ↓ 10: 9.8 ←	Serie 6
		Serie 93 (1x) Total 442 (5x)	1: 8.8 ↘ 2: 10.3 ↘ 3: 10.1 ↘ 4: 8.4 ↘ 5: 9.1 → 6: 9.4 ↘ 7: 9.6 ← 8: 7.2 ↑ 9: 9.4 ← 10: 9.3 →
		Serie 88 (0x) Total 530 (5x)	

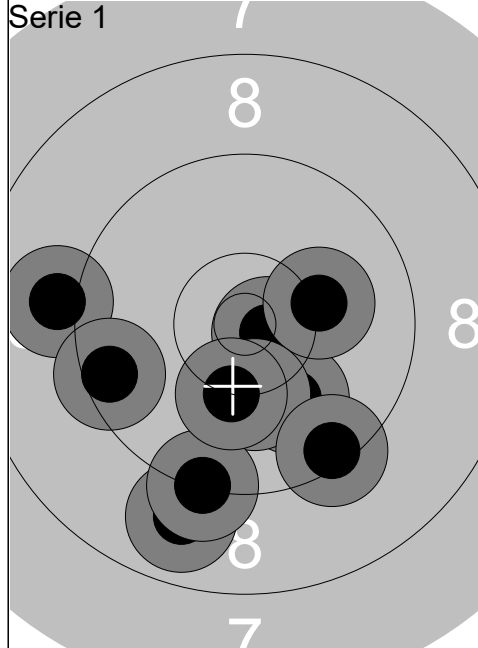

1:	10.7x	➔
2:	10.0	↘
3:	10.2	➔
4:	8.9	↘
5:	10.2	↘
6:	9.4	↘
7:	9.0	←
8:	9.3	↘
9:	10.2	↘
10:	9.5	←
Serie	94	(1x)
Total	94	(1x)

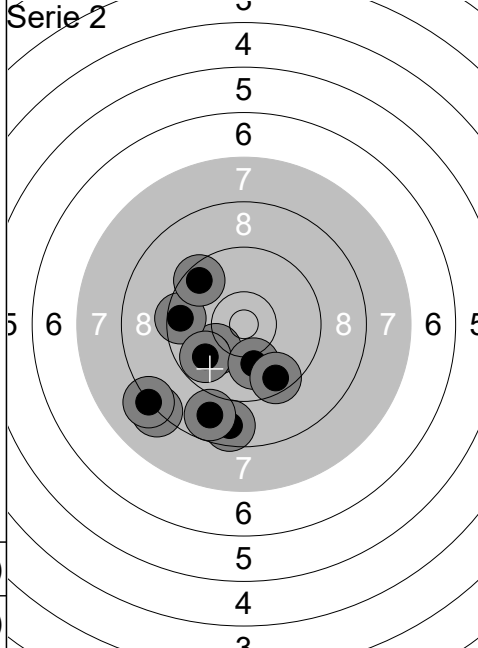

1:	10.1	↘
2:	9.5	←
3:	8.2	↘
4:	9.8	↘
5:	10.0	↘
6:	8.2	↘
7:	9.6	↘
8:	8.7	↘
9:	8.8	↘
10:	9.5	↘
Serie	88	(0x)
Total	182	(1x)

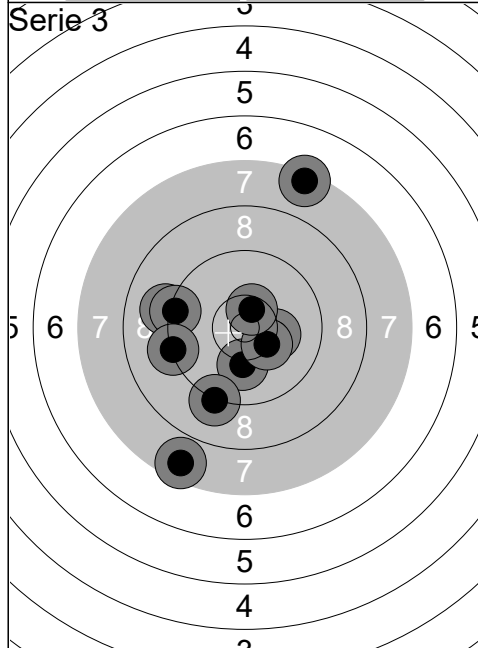

1:	10.1	↘
2:	9.1	←
3:	9.4	←
4:	7.6	↘
5:	9.3	←
6:	10.2	➔
7:	10.3	➔
8:	10.5x	↗
9:	9.2	↘
10:	7.4	↗
Serie	90	(1x)
Total	272	(2x)

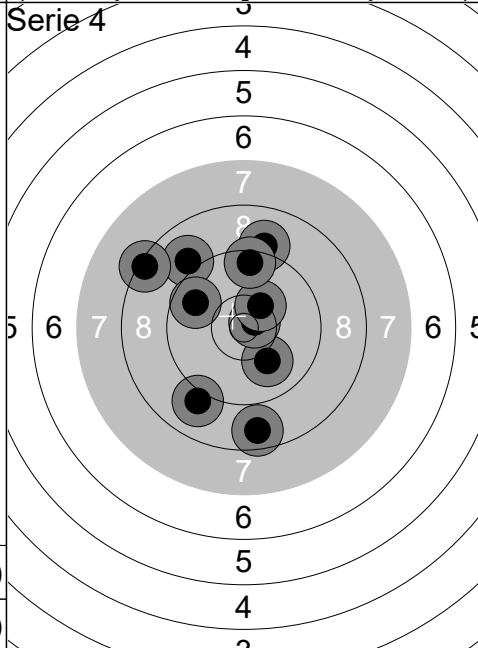

1:	10.0	↘
2:	9.0	↗
3:	10.7x	➔
4:	9.0	↘
5:	9.7	←
6:	8.6	↘
7:	8.3	↗
8:	10.3	↗
9:	9.1	↗
10:	9.5	↗
Serie	91	(1x)
Total	363	(3x)

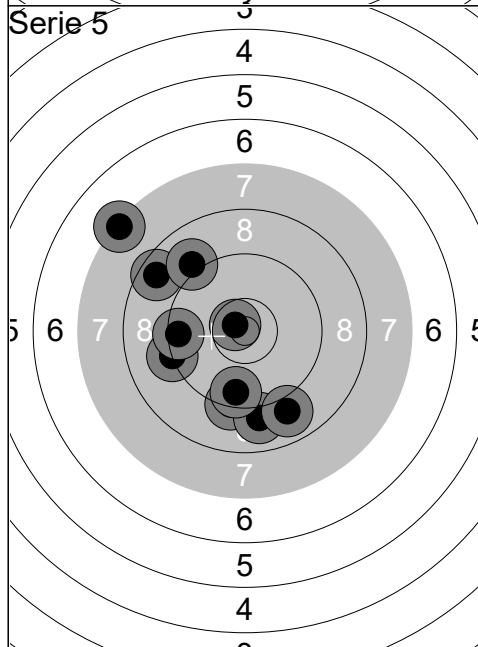

1:	9.3	↘
2:	9.0	↘
3:	9.2	←
4:	8.6	↗
5:	10.7x	↘
6:	9.6	↘
7:	7.3	↗
8:	9.1	↗
9:	9.5	←
10:	8.9	↘
Serie	87	(1x)
Total	450	(4x)

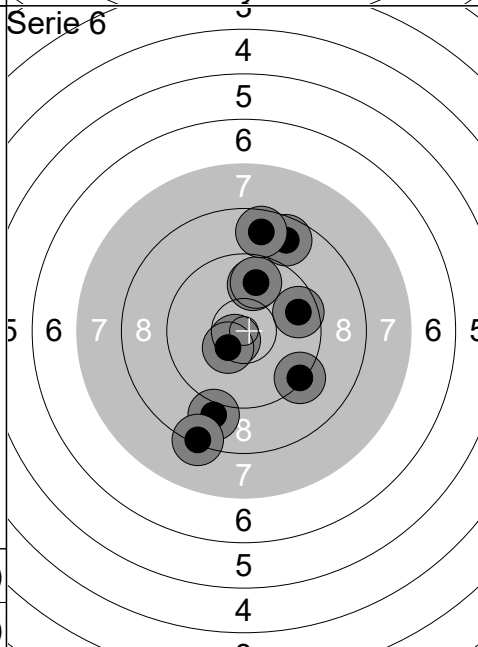

1:	9.3	↘
2:	9.0	↘
3:	9.7	➔
4:	9.9	↗
5:	9.8	↗
6:	8.7	↗
7:	8.3	↘
8:	8.7	↗
9:	10.7x	↘
10:	10.4x	↘
Serie	89	(2x)
Total	539	(6x)

Skjutlag	Tavla	Jasmine Kranendonk	
1	27	Aleholms Skytteförening	DJ Y
10 m juniorer		SM & JSM 10 m pistol	Umeå skytteallians
25.03.2023			
Serie 1 	1: 9.6 →	Serie 2 	1: 9.6 ↗
	2: 9.7 ←		2: 9.8 ←
	3: 10.5x →		3: 9.3 ↓
	4: 10.3 ↓		4: 10.3 ↙
	5: 9.6 ↗		5: 9.9 ↙
	6: 9.6 ↗		6: 10.0 →
	7: 8.9 →		7: 9.0 →
	8: 8.7 ↑		8: 9.9 ↘
	9: 9.5 ↑		9: 9.2 ↗
	10: 9.8 ↗		10: 9.1 ↗
	Serie 90 (1x)		Serie 92 (0x)
	Total 90 (1x)		Total 182 (1x)
Serie 3 	1: 10.1 ↓	Serie 4 	1: 9.9 ↖
	2: 10.3 ↑		2: 8.1 ←
	3: 9.6 ←		3: 8.5 ↙
	4: 7.4 ↗		4: 8.5 ↓
	5: 9.5 ←		5: 9.1 →
	6: 8.7 ↓		6: 9.2 ↙
	7: 10.4x ←		7: 10.8x ↗
	8: 10.2 ↓		8: 8.7 ↙
	9: 9.9 ←		9: 10.0 ↑
	10: 8.1 ↑		10: 10.6x ↓
	Serie 90 (1x)		Serie 89 (2x)
	Total 272 (2x)		Total 361 (4x)
Serie 5 	1: 9.6 ↓	Serie 6 	1: 10.6x ←
	2: 10.1 ↖		2: 9.3 ↖
	3: 8.8 ↓		3: 8.0 →
	4: 9.4 ←		4: 10.1 ←
	5: 9.8 ↓		5: 9.1 ↓
	6: 10.4x ↗		6: 10.4x ↗
	7: 8.3 →		7: 9.2 ←
	8: 8.9 ↓		8: 9.0 ↗
	9: 9.2 ↓		9: 10.0 ←
	10: 8.6 ↓		10: 9.6 ↗
	Serie 88 (1x)		Serie 93 (2x)
	Total 449 (5x)		Total 542 (7x)

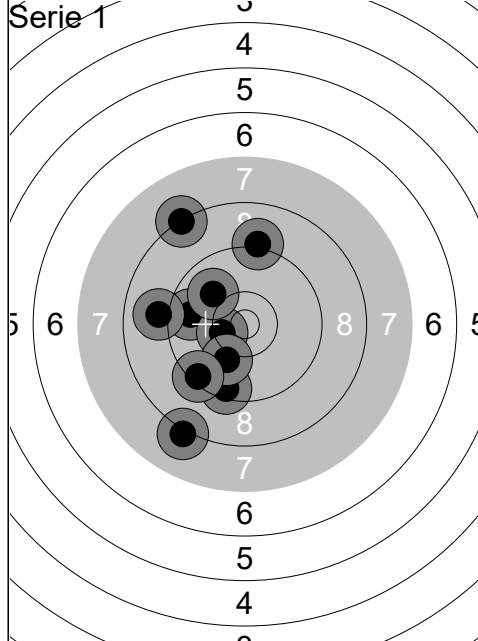

1:	9.4	↘
2:	9.7	←
3:	9.1	↑
4:	8.3	↗
5:	10.4x	←
6:	10.0	↖
7:	8.1	↘
8:	9.0	←
9:	10.0	↘
10:	9.4	↘
Serie	91	(1x)
Total	91	(1x)

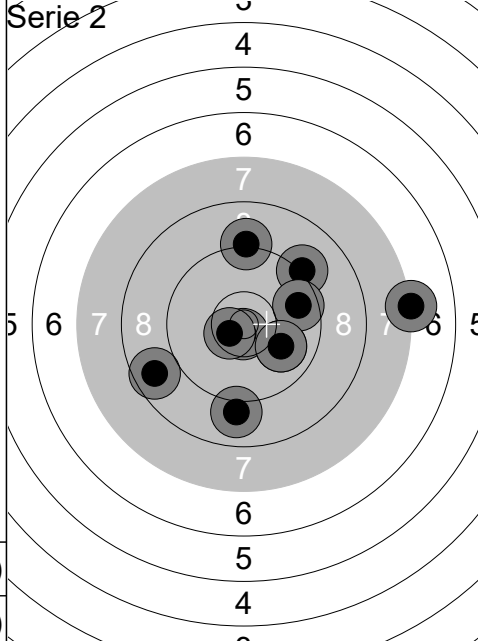

1:	8.7	↙
2:	10.0	↘
3:	10.7x	↘
4:	10.6x	↙
5:	9.2	↑
6:	9.0	↘
7:	9.2	↗
8:	7.2	→
9:	9.7	↗
10:	10.0	↘
Serie	91	(2x)
Total	182	(3x)

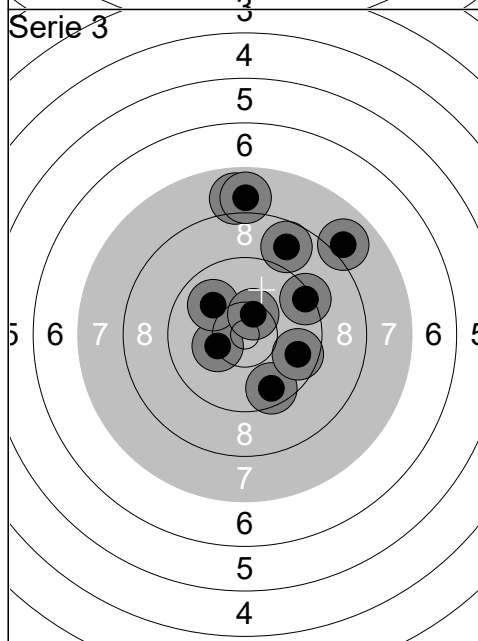

1:	10.3	←
2:	9.6	↘
3:	9.4	↗
4:	8.8	↗
5:	7.9	↑
6:	9.7	→
7:	10.0	↖
8:	10.4x	↗
9:	7.9	↑
10:	8.0	↗
Serie	87	(1x)
Total	269	(4x)

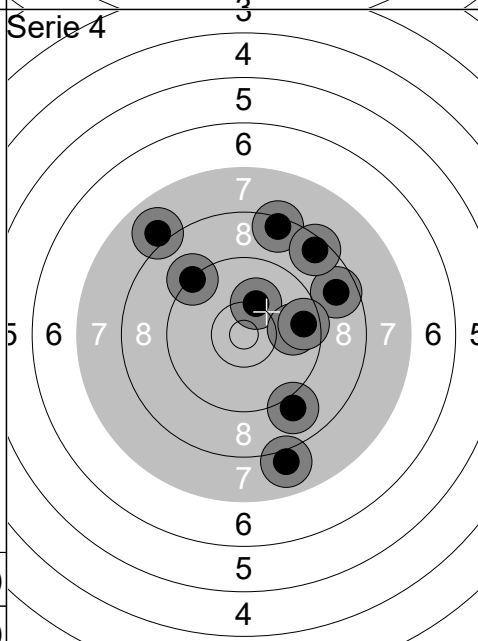

1:	9.0	↘
2:	9.3	↗
3:	8.7	↗
4:	8.0	↘
5:	10.2	↑
6:	8.4	↑
7:	9.8	→
8:	8.5	↗
9:	9.6	→
10:	8.0	↖
Serie	86	(0x)
Total	355	(4x)

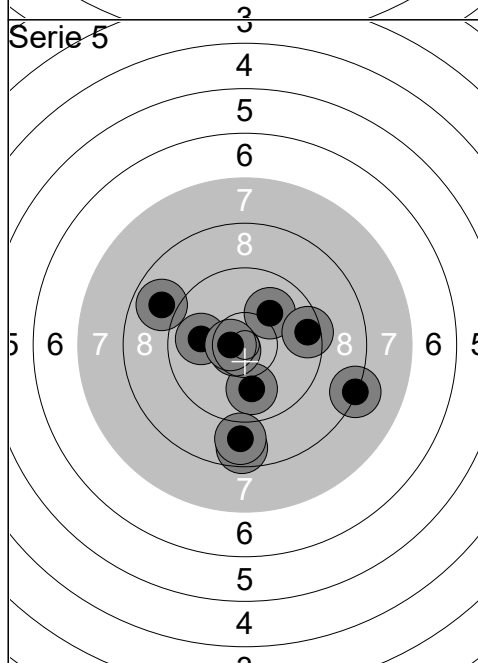

1:	10.1	↗
2:	10.0	↘
3:	8.6	↘
4:	8.9	←
5:	8.9	↘
6:	10.7x	↙
7:	9.5	→
8:	10.0	←
9:	10.6x	←
10:	8.3	→
Serie	91	(2x)
Total	446	(6x)

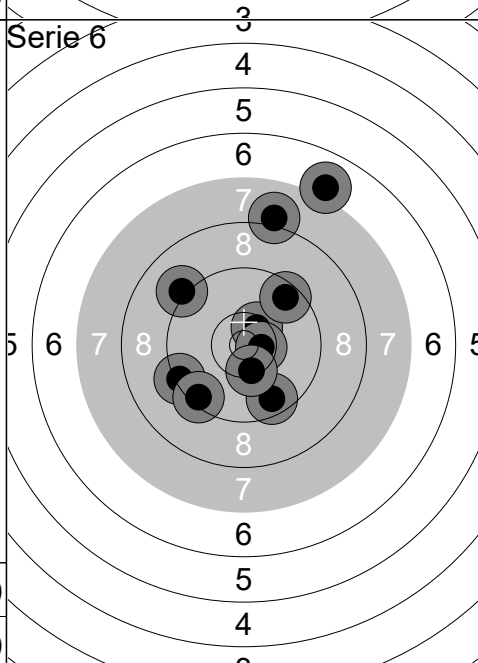

1:	9.6	↘
2:	8.0	↑
3:	10.5x	↗
4:	10.5x	→
5:	9.5	↗
6:	9.1	↖
7:	9.3	←
8:	9.4	↘
9:	7.0	↑
10:	10.3	↘
Serie	90	(2x)
Total	536	(8x)

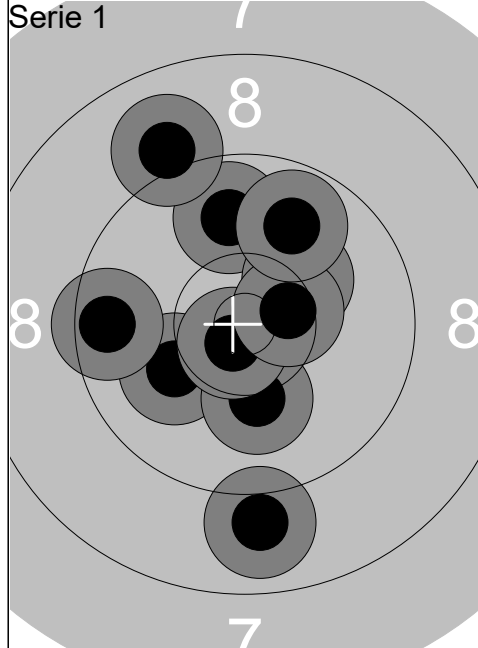

1:	8.9	↓
2:	10.1	↙
3:	9.9	↑
4:	10.2	↓
5:	10.2	↗
6:	10.7x	↘
7:	10.5x	→
8:	9.0	↖
9:	9.9	↑
10:	9.6	←
Serie	94	(2x)
Total	94	(2x)

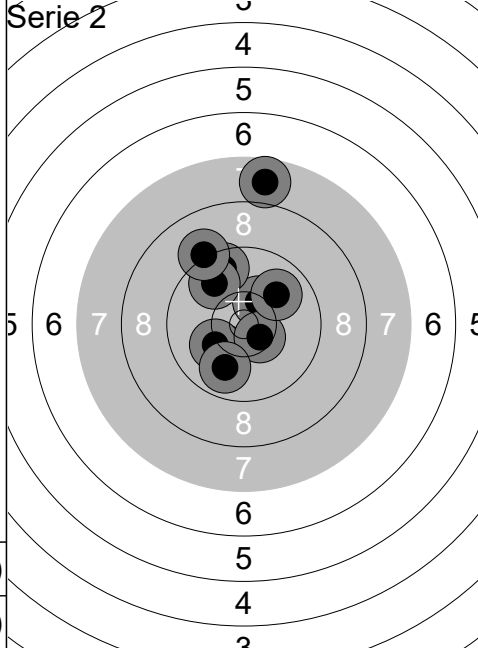

1:	10.2	↘
2:	10.4	↗
3:	9.6	↑
4:	9.8	↖
5:	10.2	↙
6:	10.5x	↘
7:	9.9	↓
8:	10.0	↗
9:	7.7	↑
10:	9.2	↖
Serie	93	(1x)
Total	187	(3x)

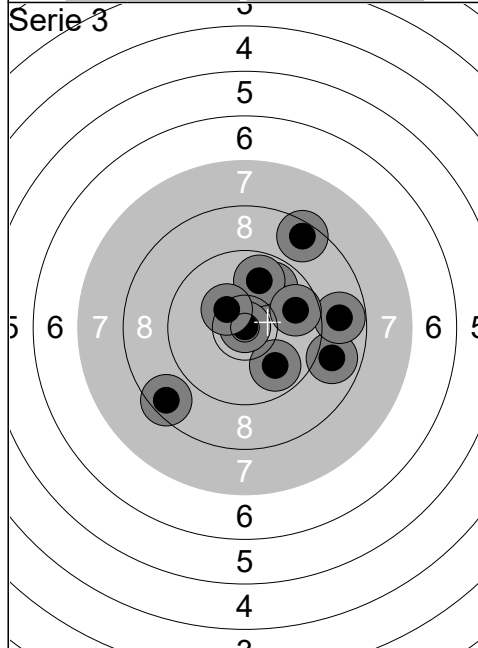

1:	8.5	↗
2:	9.9	↗
3:	8.9	→
4:	8.6	↙
5:	9.9	↘
6:	9.9	↑
7:	8.8	→
8:	9.8	→
9:	10.9x	↑
10:	10.4x	↖
Serie	88	(2x)
Total	275	(5x)

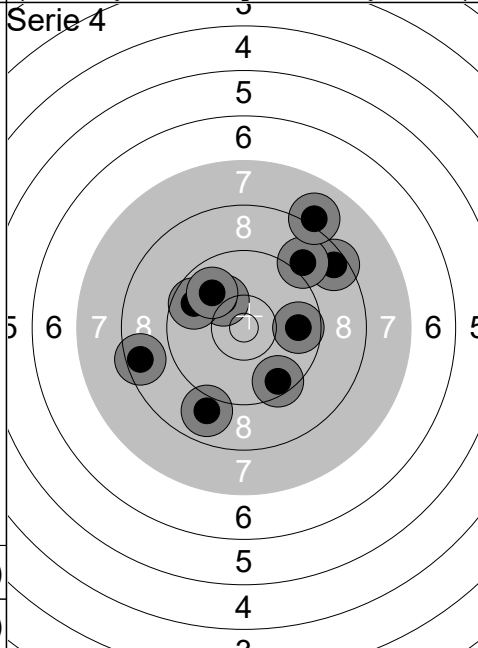

1:	10.2	↖
2:	9.7	↙
3:	8.5	↗
4:	8.5	←
5:	9.7	→
6:	9.9	↖
7:	9.0	↗
8:	9.5	↘
9:	8.1	↗
10:	8.9	↘
Serie	87	(0x)
Total	362	(5x)

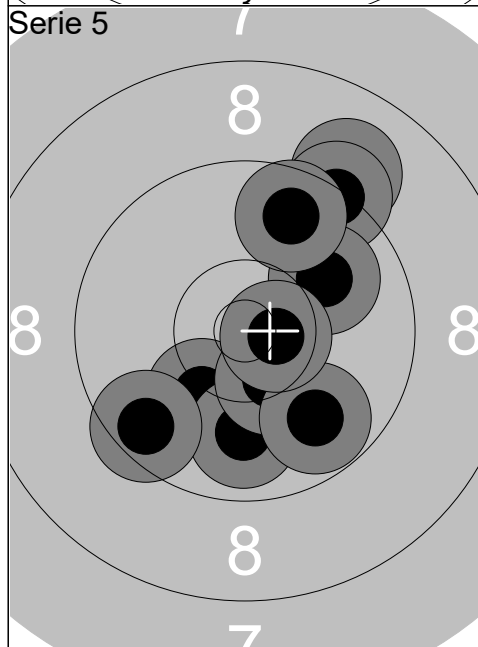

1:	9.1	↗
2:	9.3	↗
3:	10.2	↘
4:	9.9	↓
5:	10.4x	↘
6:	10.0	↗
7:	9.6	↙
8:	9.8	↘
9:	10.6x	→
10:	9.7	↑
Serie	94	(2x)
Total	456	(7x)

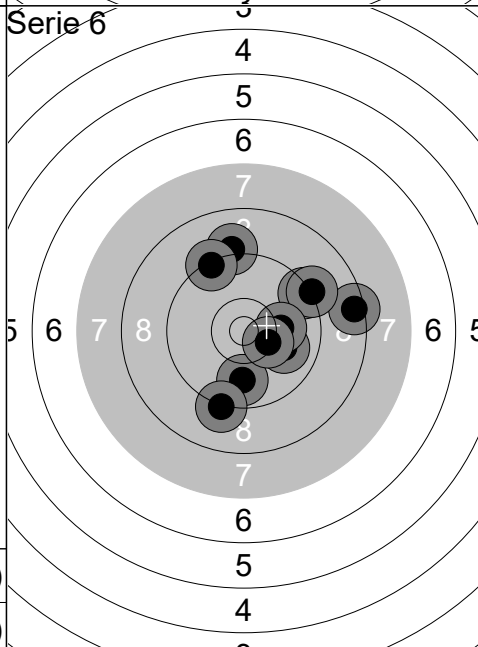

1:	9.4	↗
2:	8.4	→
3:	9.9	↓
4:	9.2	↗
5:	10.0	→
6:	9.2	↓
7:	10.1	→
8:	10.3	→
9:	9.1	↑
10:	9.3	↖
Serie	92	(0x)
Total	548	(7x)

Skjutlag	Tavla	Pauline Rönnqvist		
1	31	10 m juniorer	Töreboda Pistolskytteklubb	
25.03.2023		SM & JSM 10 m pistol	DJ Ä	
25.03.2023		SM & JSM 10 m pistol	Umeå skytteallians	
	1: 8.8 ↓		1: 8.4 ←	
	2: 10.4x ↙		2: 10.4x ↓	2: 10.4x ↓
	3: 9.3 →		3: 9.7 ↑	3: 9.7 ↑
	4: 8.5 ↗		4: 9.4 ↗	4: 9.4 ↗
	5: 9.6 ←		5: 9.7 ↗	5: 9.7 ↗
	6: 10.0 ↗		6: 6.8 ←	6: 6.8 ←
	7: 9.8 ↗		7: 10.4x ↓	7: 10.4x ↓
	8: 8.2 ↑		8: 10.1 ←	8: 10.1 ←
	9: 5.4 ↙		9: 8.5 ↗	9: 8.5 ↗
	10: 8.2 ↑		10: 7.8 ↗	10: 7.8 ↗
Serie 84 (1x)	Serie 86 (2x)	Serie 86 (2x)	Serie 86 (2x)	
Total 84 (1x)	Total 170 (3x)	Total 170 (3x)	Total 170 (3x)	
	1: 9.0 ↑		1: 8.2 ↓	
	2: 9.7 ↑		2: 9.7 ↓	2: 9.7 ↓
	3: 9.5 ↓		3: 8.5 ↗	3: 8.5 ↗
	4: 8.8 ←		4: 9.8 ←	4: 9.8 ←
	5: 8.2 ↙		5: 9.2 →	5: 9.2 →
	6: 9.4 ↓		6: 7.9 ↗	6: 7.9 ↗
	7: 9.5 ↑		7: 9.4 ↗	7: 9.4 ↗
	8: 10.1 ↓		8: 10.4 ↗	8: 10.4 ↗
	9: 8.7 →		9: 9.1 ←	9: 9.1 ←
	10: 9.6 →		10: 9.0 ↓	10: 9.0 ↓
Serie 88 (0x)	Serie 87 (0x)	Serie 87 (0x)	Serie 87 (0x)	
Total 258 (3x)	Total 345 (3x)	Total 345 (3x)	Total 345 (3x)	
	1: 8.8 →		1: 9.2 ↖	
	2: 8.6 ←		2: 9.7 →	2: 9.7 →
	3: 8.8 ↓		3: 8.7 ↑	3: 8.7 ↑
	4: 10.2 ←		4: 9.9 ↓	4: 9.9 ↓
	5: 7.5 ←		5: 7.5 ↓	5: 7.5 ↓
	6: 9.6 ↓		6: 9.6 ←	6: 9.6 ←
	7: 9.8 ←		7: 9.0 ↗	7: 9.0 ↗
	8: 9.9 ↓		8: 7.9 ↖	8: 7.9 ↖
	9: 7.0 ←		9: 7.6 ↓	9: 7.6 ↓
	10: 10.3 ↙		10: 10.3 ↓	10: 10.3 ↓
Serie 85 (0x)	Serie 84 (0x)	Serie 84 (0x)	Serie 84 (0x)	
Total 430 (3x)	Total 514 (3x)	Total 514 (3x)	Total 514 (3x)	

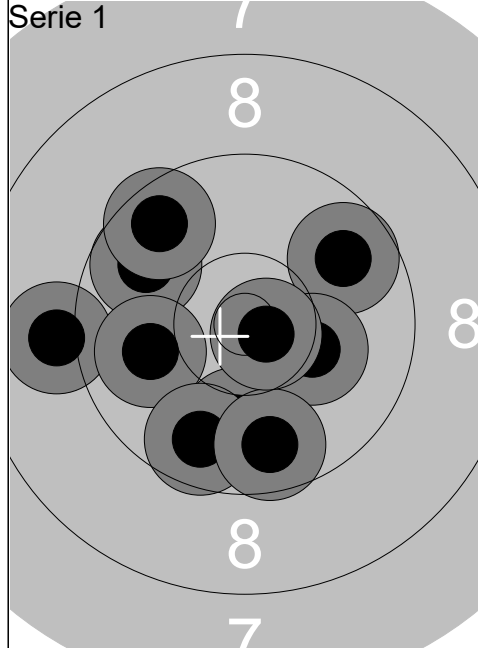

1:	9.8	↖
2:	9.9	↓
3:	9.0	←
4:	9.8	↗
5:	10.0	←
6:	10.2	→
7:	9.7	↓
8:	9.7	↓
9:	9.6	↖
10:	10.7x	→
Serie		93 (1x)
Total		93 (1x)

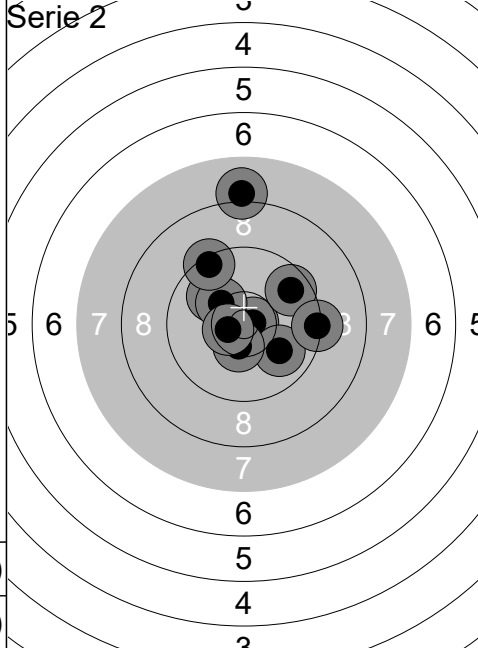

1:	10.7x	→
2:	8.0	↑
3:	9.7	↗
4:	10.0	↖
5:	10.0	↘
6:	9.3	→
7:	10.4x	↓
8:	10.3	↖
9:	9.4	↖
10:	10.6x	←
Serie		95 (3x)
Total		188 (4x)

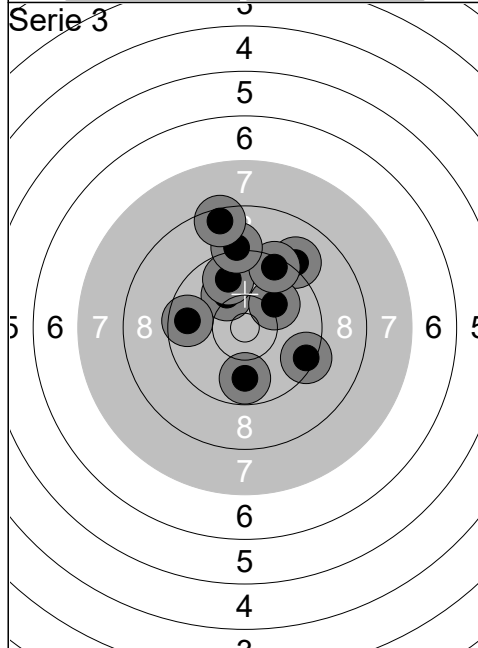

1:	10.1	↖
2:	9.1	↗
3:	10.1	↗
4:	9.6	←
5:	9.8	↑
6:	9.4	↗
7:	9.8	↓
8:	9.4	→
9:	9.1	↑
10:	8.5	↑
Serie		91 (0x)
Total		279 (4x)

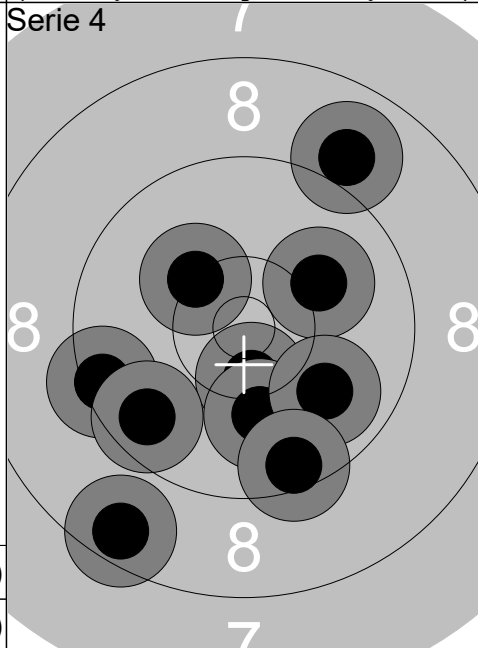

1:	8.6	↘
2:	8.9	↗
3:	9.4	←
4:	10.4x	↓
5:	9.6	↘
6:	10.1	↓
7:	10.3	↖
8:	10.1	↗
9:	9.9	↘
10:	9.5	↓
Serie		92 (1x)
Total		371 (5x)

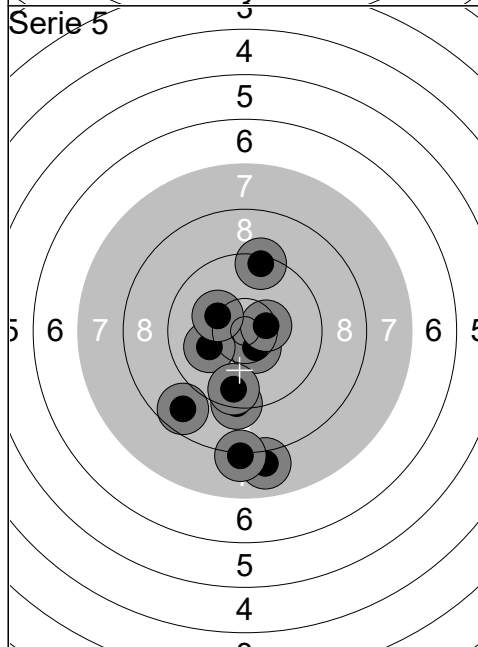

1:	10.5x	↘
2:	10.1	←
3:	9.3	↓
4:	8.0	↓
5:	9.4	↑
6:	10.4x	→
7:	9.6	↓
8:	8.7	↘
9:	8.2	↓
10:	10.3	↖
Serie		91 (2x)
Total		462 (7x)

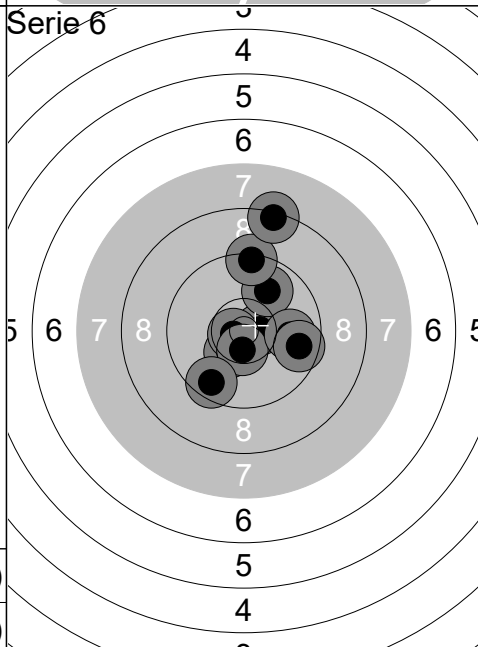

1:	10.6x	→
2:	9.9	↗
3:	10.4x	↘
4:	10.7x	←
5:	10.5x	↓
6:	9.6	↘
7:	9.4	↑
8:	9.9	→
9:	8.3	↑
10:	9.7	→
Serie		93 (4x)
Total		555 (11x)

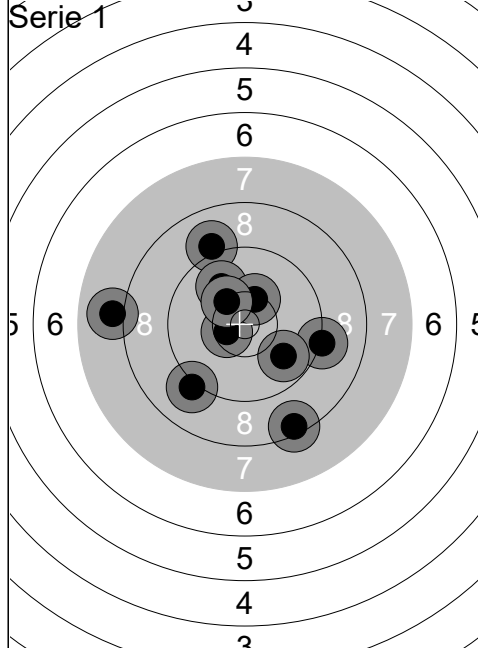

1:	9.1	↗
2:	8.4	↘
3:	10.5x	↙
4:	9.1	↘
5:	10.0	↗
6:	10.3	↗
7:	10.3	↗
8:	9.2	➡
9:	9.8	↘
10:	8.0	↙
Serie		92 (1x)
Total		92 (1x)

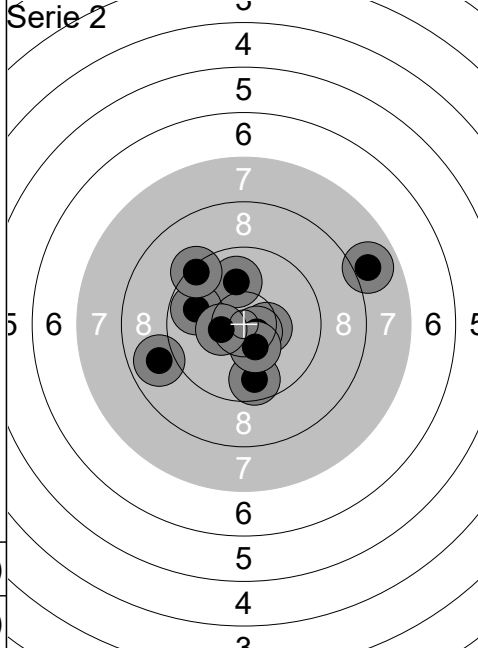

1:	9.7	↘
2:	10.0	↗
3:	10.4x	➡
4:	10.6x	➡
5:	7.9	➡
6:	8.9	↙
7:	9.8	↙
8:	9.4	↗
9:	10.4x	↘
10:	10.4x	↙
Serie		92 (4x)
Total		184 (5x)

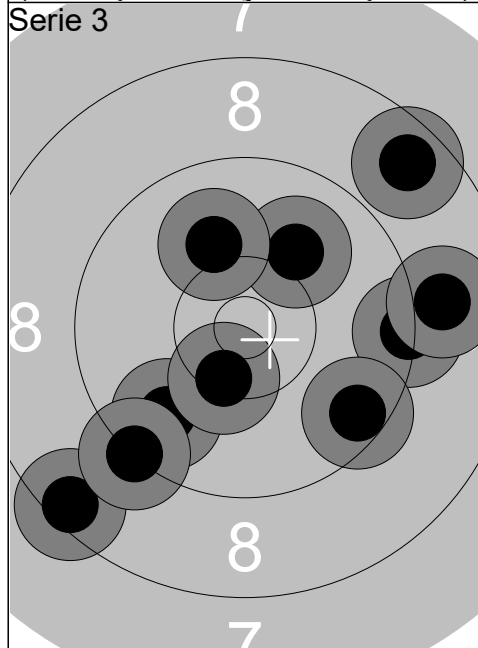

1:	8.4	↘
2:	9.3	➡
3:	10.0	↗
4:	9.8	↘
5:	8.9	➡
6:	10.4x	↘
7:	9.5	↘
8:	10.1	↗
9:	9.2	↘
10:	8.6	↗
Serie		90 (1x)
Total		274 (6x)

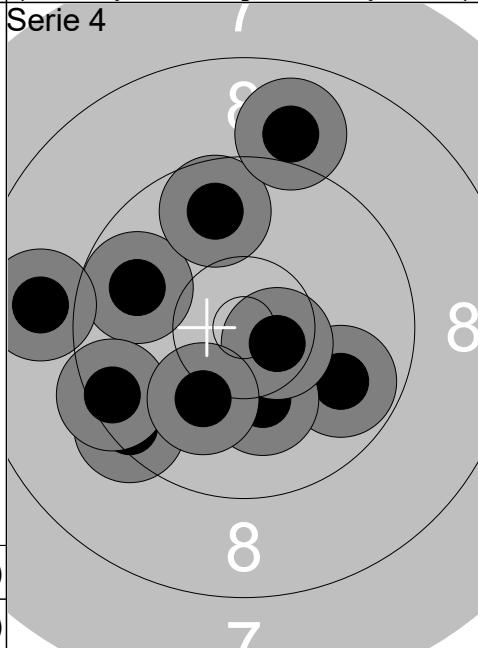

1:	9.8	↙
2:	9.7	↗
3:	9.8	➡
4:	9.4	↘
5:	8.9	↙
6:	9.5	↙
7:	8.9	↗
8:	10.2	↘
9:	10.6x	➡
10:	10.1	↘
Serie		91 (1x)
Total		365 (7x)

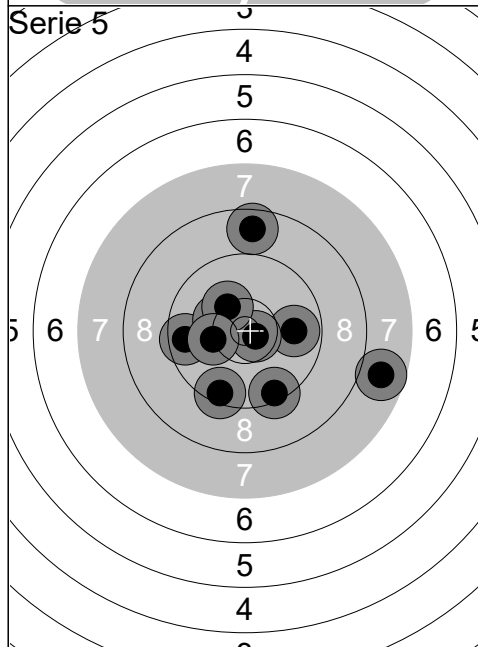

1:	9.8	➡
2:	9.6	↙
3:	10.3	↙
4:	9.5	↘
5:	10.7x	➡
6:	9.4	↘
7:	8.7	↗
8:	10.3	↗
9:	10.2	↙
10:	7.8	➡
Serie		91 (1x)
Total		456 (8x)

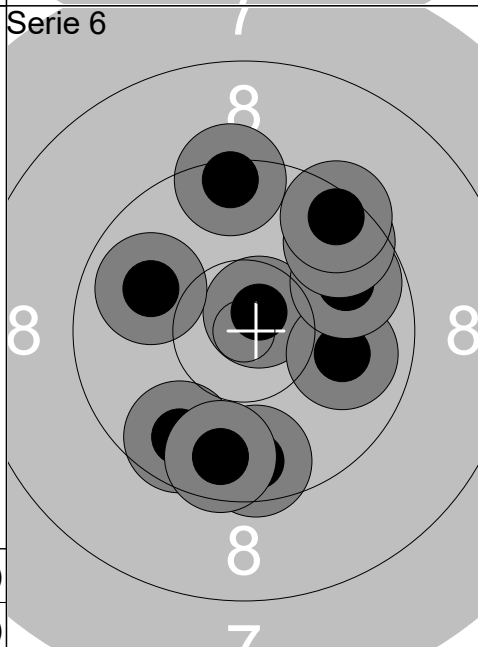

1:	9.6	↘
2:	10.7x	↗
3:	9.4	↗
4:	9.9	➡
5:	9.8	➡
6:	9.6	↗
7:	9.5	↗
8:	9.9	↙
9:	9.7	↘
10:	9.7	↘
Serie		91 (1x)
Total		547 (9x)

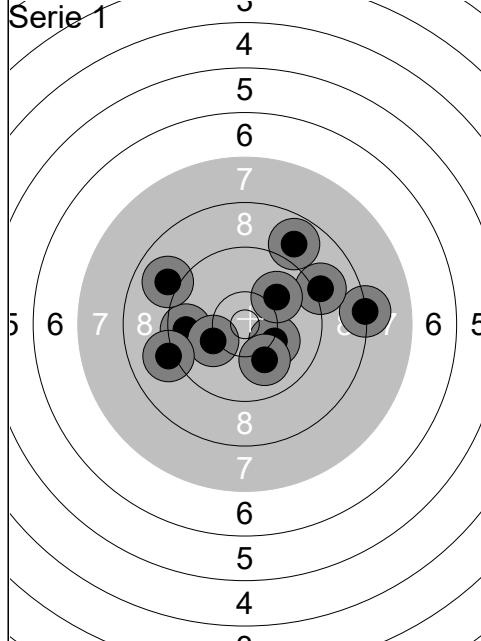

1:	8.2	→
2:	9.6	←
3:	10.1	←
4:	9.0	↖
5:	10.2	⇒
6:	9.1	→
7:	8.8	↗
8:	9.1	←
9:	10.0	↓
10:	10.0	↗
Serie		92 (0x)
Total		92 (0x)

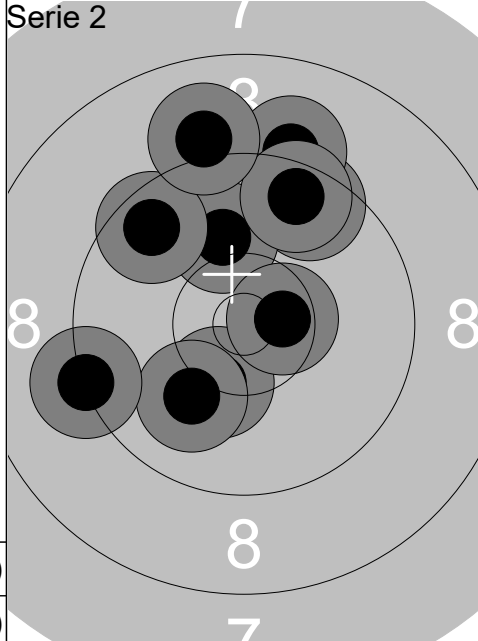

1:	10.3	↘
2:	10.0	↘
3:	9.6	↗
4:	10.0	↑
5:	9.6	↖
6:	9.1	↑
7:	9.5	↑
8:	9.0	↑
9:	10.6x	→
10:	9.2	←
Serie		94 (1x)
Total		186 (1x)

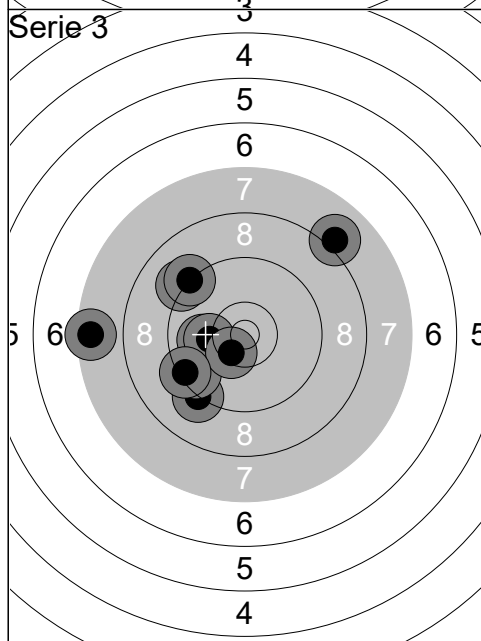

1:	9.2	↖
2:	7.5	←
3:	9.2	↘
4:	8.0	↗
5:	10.0	←
6:	9.6	←
7:	9.2	↖
8:	10.1	←
9:	10.4x	↘
10:	9.4	←
Serie		90 (1x)
Total		276 (2x)

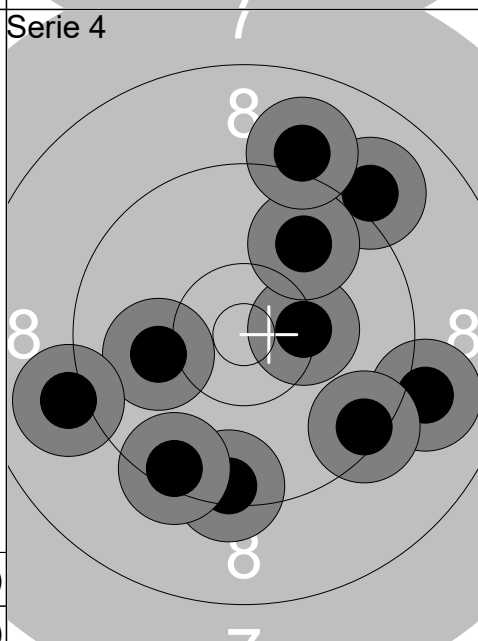

1:	9.0	⇒
2:	10.1	←
3:	10.3	→
4:	9.4	↓
5:	9.0	↗
6:	9.8	↗
7:	9.4	↘
8:	9.1	←
9:	9.0	↑
10:	9.4	↘
Serie		92 (0x)
Total		368 (2x)

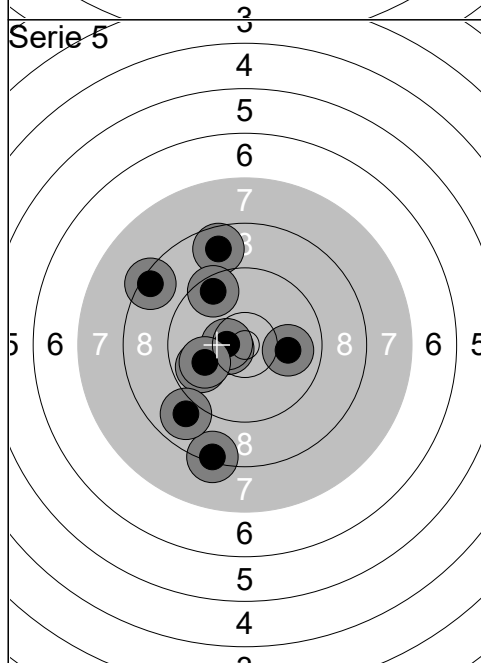

1:	8.4	↖
2:	8.7	↑
3:	8.3	↘
4:	9.8	←
5:	10.6x	←
6:	9.6	↗
7:	10.5x	←
8:	10.0	←
9:	8.9	↘
10:	10.0	→
Serie		90 (2x)
Total		458 (4x)

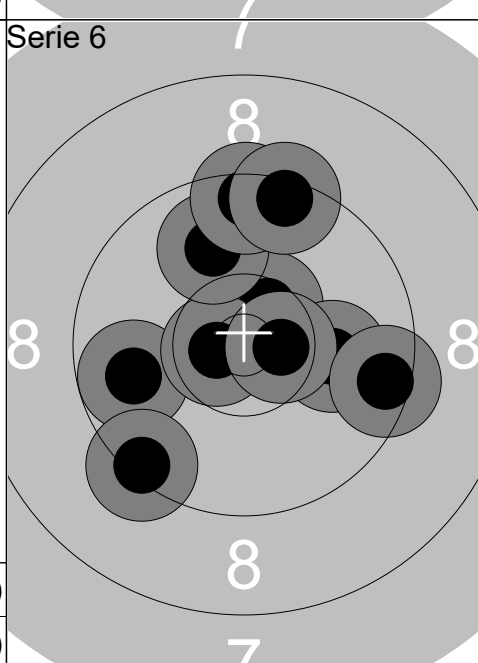

1:	10.5x	↗
2:	9.8	←
3:	10.7x	←
4:	9.9	↑
5:	10.0	→
6:	9.5	↑
7:	10.6x	→
8:	9.4	↘
9:	9.4	↑
10:	9.5	⇒
Serie		94 (3x)
Total		552 (7x)

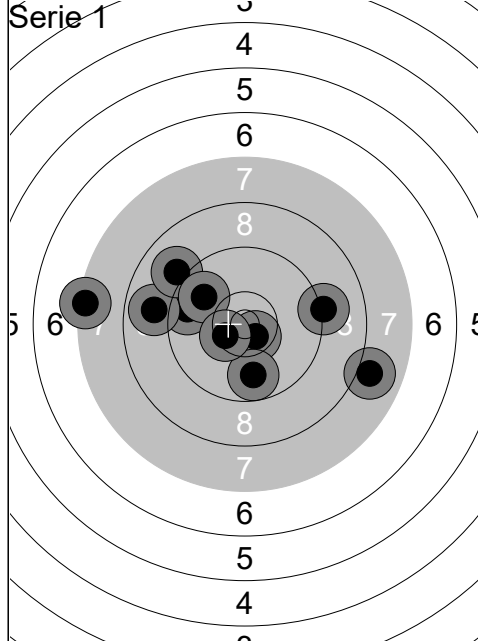

1:	10.6x	↘
2:	9.8	↓
3:	9.6	←
4:	8.9	←
5:	9.0	↗
6:	7.9	→
7:	9.2	→
8:	9.8	↖
9:	7.4	←
10:	10.4x	↙
Serie		87 (2x)
Total		87 (2x)

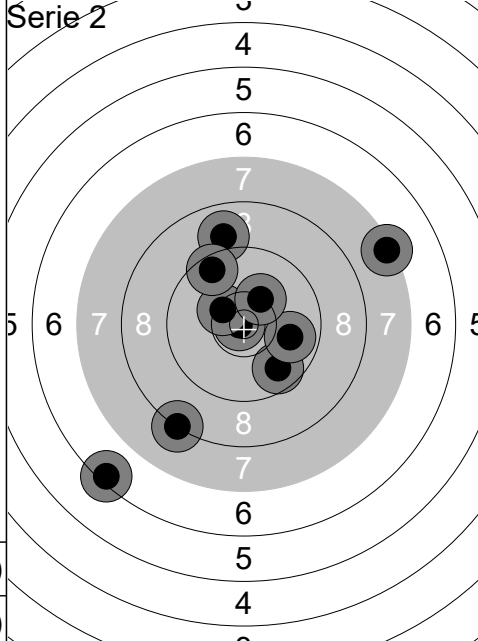

1:	9.7	↘
2:	8.9	↑
3:	10.8x	←
4:	8.2	↘
5:	6.4	↘
6:	10.4x	↖
7:	9.9	→
8:	7.4	↗
9:	10.3	↗
10:	9.5	↖
Serie		86 (2x)
Total		173 (4x)

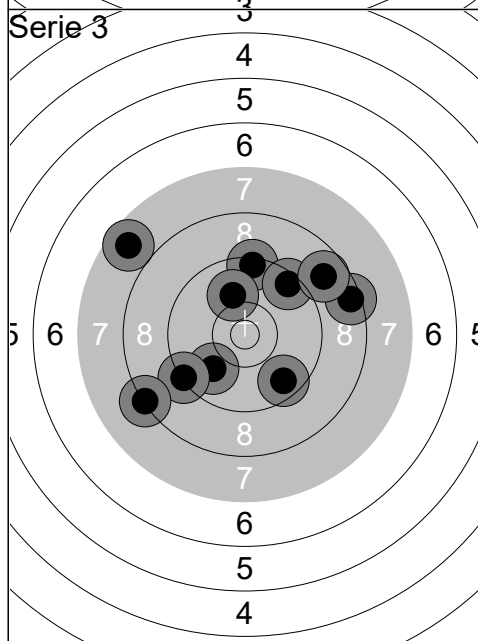

1:	9.4	↑
2:	7.7	↖
3:	9.6	↘
4:	9.5	↗
5:	9.9	↘
6:	10.0	↑
7:	9.3	←
8:	8.5	↗
9:	8.3	←
10:	8.8	↗
Serie		86 (0x)
Total		259 (4x)

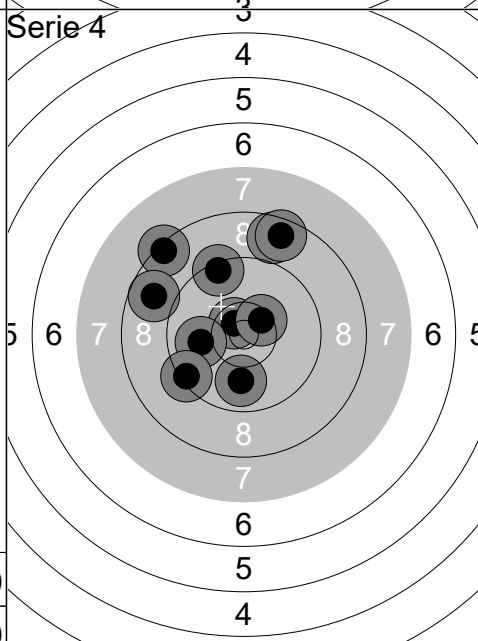

1:	10.6x	↖
2:	9.4	↑
3:	10.4x	↗
4:	8.4	↖
5:	8.7	↑
6:	10.0	←
7:	9.4	←
8:	8.8	←
9:	8.6	↑
10:	9.9	↓
Serie		89 (2x)
Total		348 (6x)

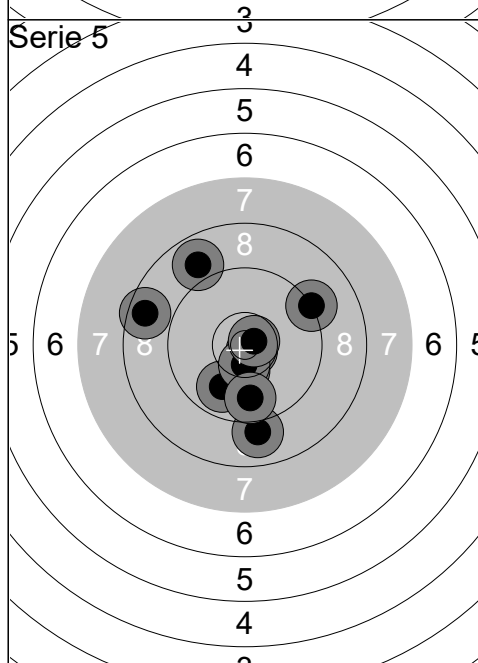

1:	10.4x	↓
2:	8.9	↖
3:	8.6	←
4:	10.7x	↘
5:	9.2	↗
6:	9.9	↘
7:	10.5x	↓
8:	9.0	↓
9:	10.7x	↗
10:	9.7	↓
Serie		92 (4x)
Total		440 (10x)

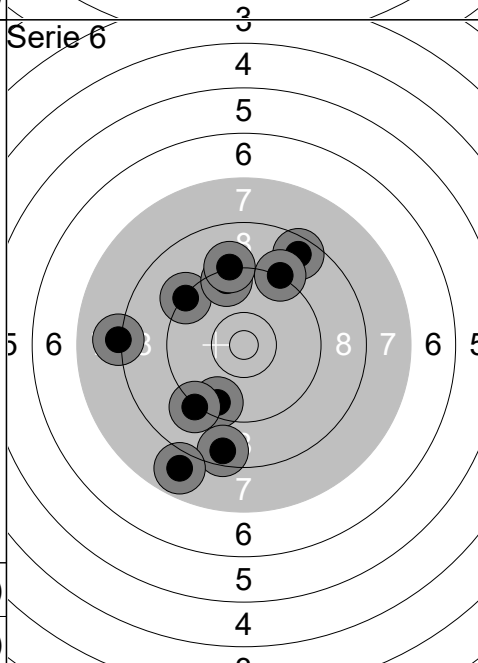

1:	9.5	↘
2:	8.6	↗
3:	9.2	↘
4:	9.3	↖
5:	8.1	←
6:	8.5	↓
7:	9.5	↑
8:	9.2	↑
9:	9.2	↗
10:	7.8	↘
Serie		85 (0x)
Total		525 (10x)

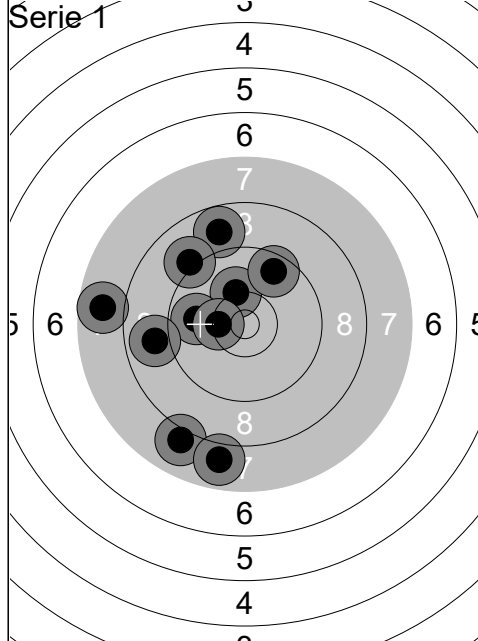

1:	9.6	↖
2:	10.3	↗
3:	9.6	↑
4:	8.9	↘
5:	9.0	→
6:	9.8	←
7:	8.6	↖
8:	9.7	↖
9:	9.3	↘
10:	9.6	↘
Serie	89	(0x)
Total	174	(1x)

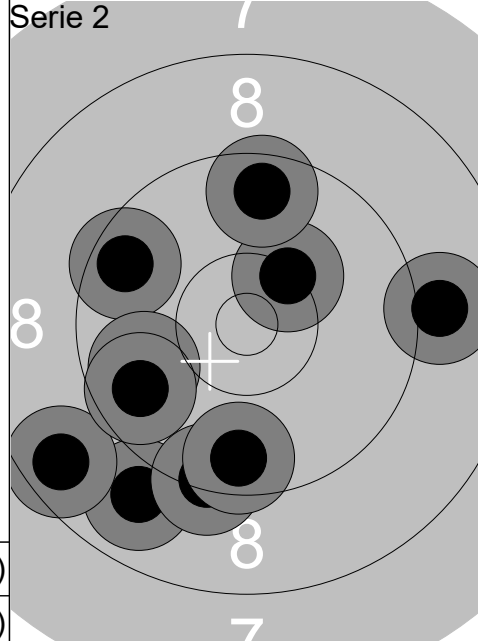

1:	9.7	→
2:	10.6x	↖
3:	9.0	↘
4:	8.0	↘
5:	8.3	←
6:	8.6	↖
7:	9.5	→
8:	9.6	↗
9:	10.3	↗
10:	9.7	↗
Serie	89	(1x)
Total	263	(2x)

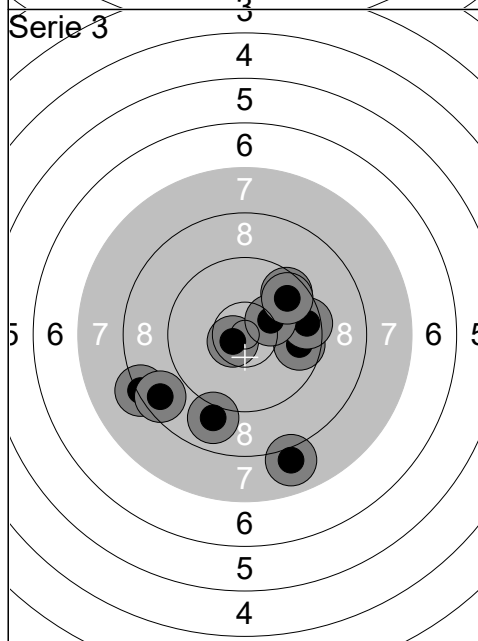

1:	9.3	↖
2:	9.8	↘
3:	8.4	↘
4:	10.1	↗
5:	9.6	↖
6:	8.5	→
7:	9.3	↗
8:	8.7	↘
9:	7.7	←
10:	10.5x	↗
Serie	87	(1x)
Total	350	(3x)

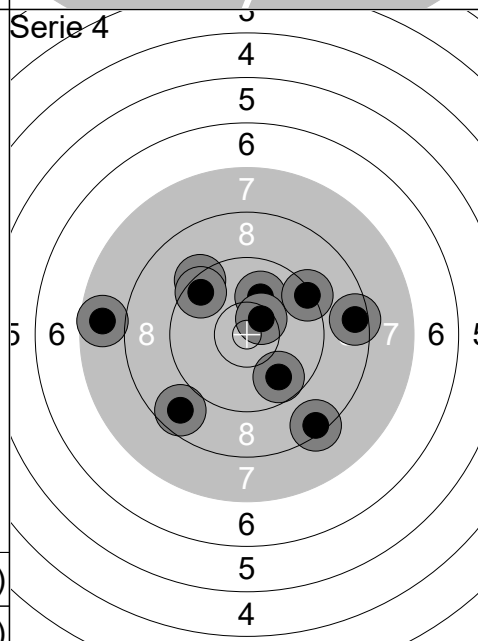

1:	8.9	↑
2:	9.2	↘
3:	9.3	↘
4:	10.0	↑
5:	8.4	↘
6:	9.2	→
7:	10.7x	↘
8:	10.7x	↘
9:	7.6	↗
10:	9.6	↘
Serie	89	(2x)
Total	439	(5x)

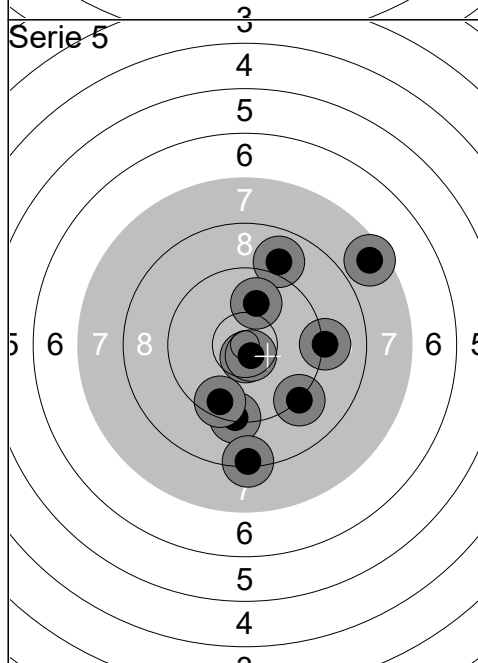

1:	8.9	↑
2:	9.2	↘
3:	9.3	↘
4:	10.0	↑
5:	8.4	↘
6:	9.2	→
7:	10.7x	↘
8:	10.7x	↘
9:	7.6	↗
10:	9.6	↘
Serie	89	(2x)
Total	439	(5x)

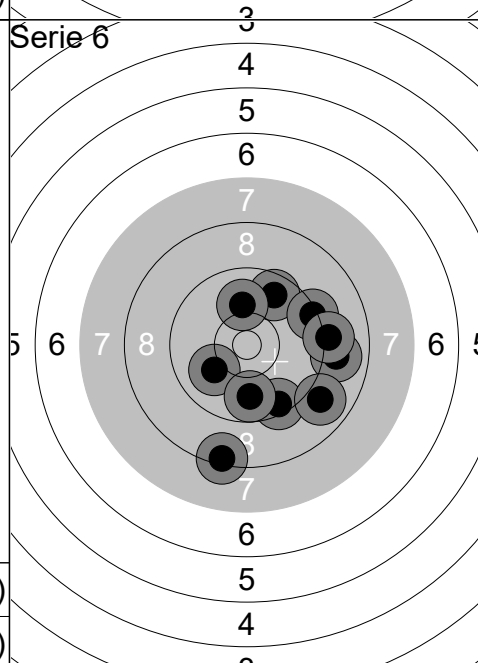

1:	9.7	↗
2:	8.9	→
3:	9.5	↘
4:	10.0	↖
5:	8.9	↘
6:	9.3	↗
7:	8.4	↘
8:	9.1	→
9:	10.0	↑
10:	9.8	↘
Serie	89	(0x)
Total	528	(5x)

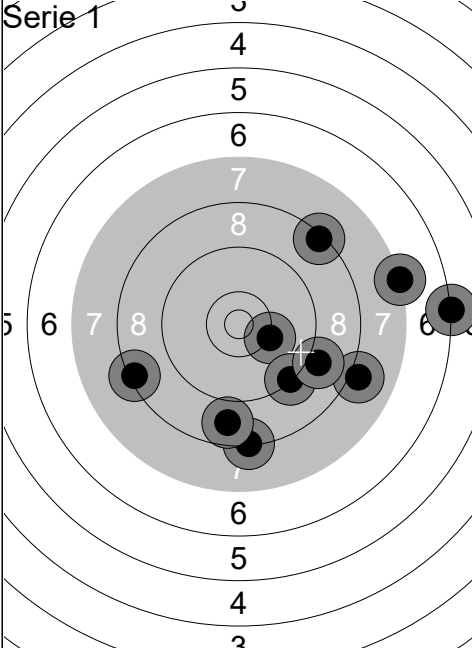
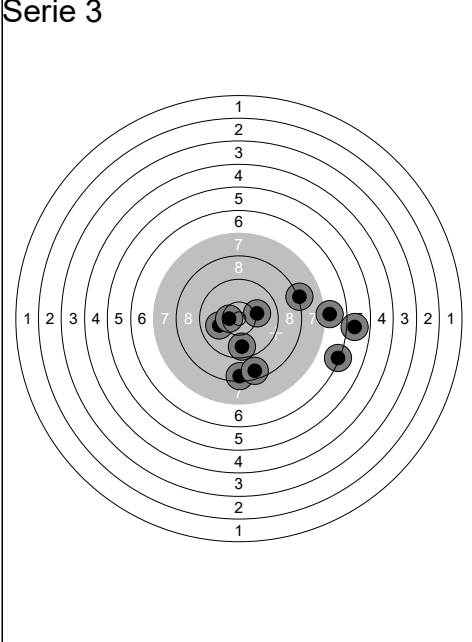
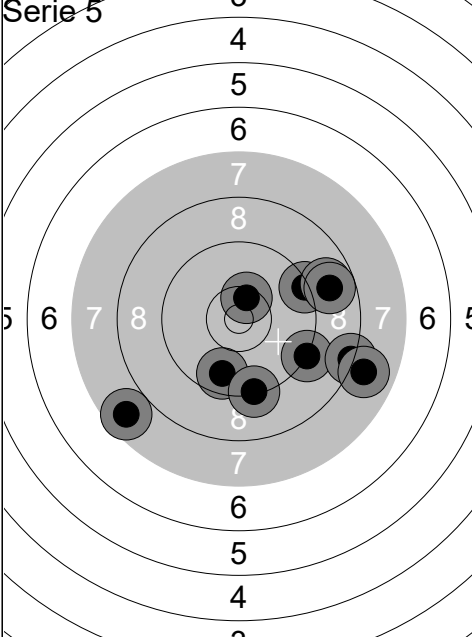
Skjuttlag	Tavla	Hanna Birk	
10 m juniorer		Luleå Sportskytteklubb	DJ Ä
25.03.2023		SM & JSM 10 m pistol	Umeå skytteallians
Serie 1		1: 7.2 → 2: 8.3 ↗ 3: 10.2 → 4: 8.4 ← 5: 8.3 ↓ 6: 9.3 ↘ 7: 8.0 → 8: 6.2 → 9: 8.7 ↓ 10: 9.0 → Serie 81 (0x) Total 81 (0x)	Serie 2
			1: 8.6 ↗ 2: 8.6 ↗ 3: 9.7 ↘ 4: 10.5x ↘ 5: 9.0 ↗ 6: 9.8 ↑ 7: 9.8 → 8: 10.0 ↘ 9: 9.7 ↓ 10: 9.3 ↘ Serie 90 (1x) Total 171 (1x)
Serie 3		1: 9.7 ↓ 2: 7.0 → 3: 8.5 ↓ 4: 10.1 → 5: 5.9 → 6: 10.0 ← 7: 8.6 ↓ 8: 10.5x ← 9: 6.3 → 10: 8.1 → Serie 81 (1x) Total 252 (2x)	Serie 4
			1: 8.8 → 2: 10.3 ← 3: 9.9 ↗ 4: 9.9 ↘ 5: 8.1 → 6: 7.5 ↓ 7: 8.0 ↓ 8: 9.6 ↗ 9: 9.4 ← 10: 5.4 ↘ Serie 82 (0x) Total 334 (2x)
Serie 5		1: 9.2 → 2: 9.7 ↓ 3: 10.4x ↗ 4: 8.3 → 5: 9.3 ↗ 6: 8.9 → 7: 7.9 → 8: 8.8 → 9: 9.3 ↓ 10: 7.7 ↘ Serie 84 (1x) Total 418 (3x)	Serie 6
			1: 8.2 ↘ 2: 10.2 ↓ 3: 8.9 → 4: 10.8x ← 5: 7.9 ↗ 6: 6.3 → 7: 7.6 ↘ 8: 7.7 → 9: 8.5 ↘ 10: 8.5 ↘ Serie 79 (1x) Total 497 (4x)

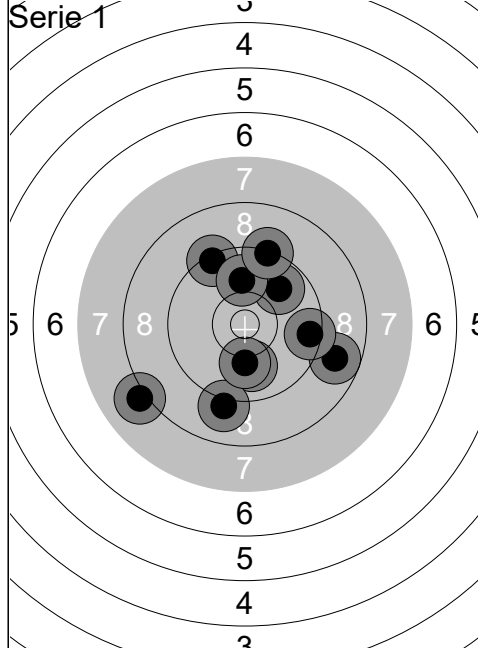

1:	9.4	↖
2:	9.8	↗
3:	10.0	↑
4:	10.0	↓
5:	8.8	⇒
6:	9.1	↓
7:	9.3	↑
8:	8.1	↙
9:	9.5	⇒
10:	10.1	↓
Serie	91 (0x)	
Total	91 (0x)	

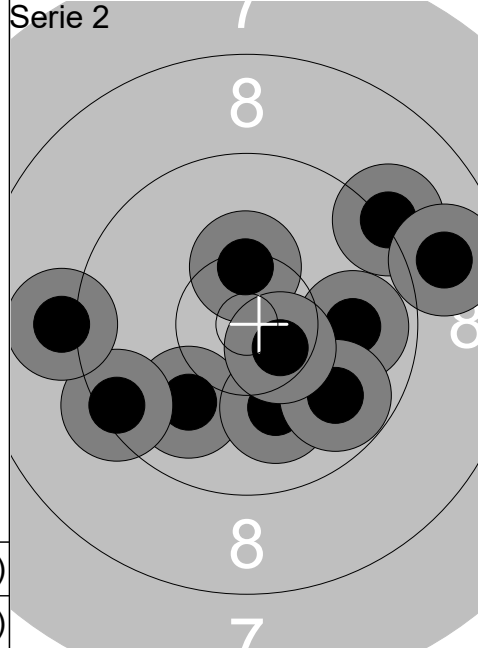

1:	10.0	↘
2:	9.4	↙
3:	9.1	←
4:	10.4x	↑
5:	9.9	⇒
6:	9.2	↗
7:	8.9	⇒
8:	10.1	↓
9:	9.8	↘
10:	10.5x	↘
Serie	93 (2x)	
Total	184 (2x)	

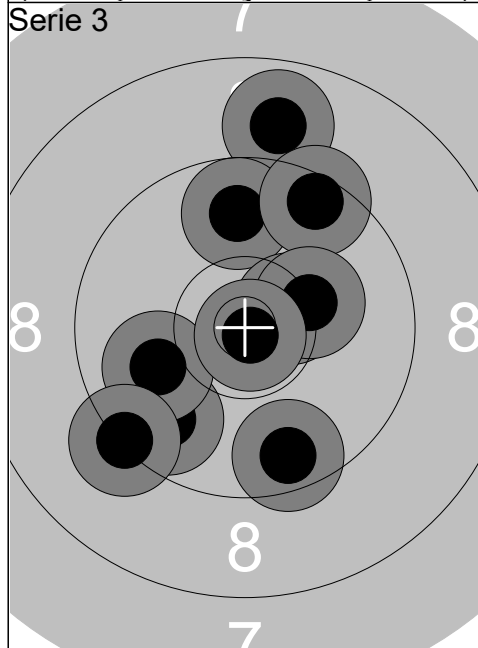

1:	9.7	↘
2:	8.9	↑
3:	9.8	↑
4:	9.5	↗
5:	10.0	↙
6:	10.5x	⇒
7:	10.2	⇒
8:	9.3	↘
9:	10.9x	↓
10:	9.6	↓
Serie	93 (2x)	
Total	277 (4x)	

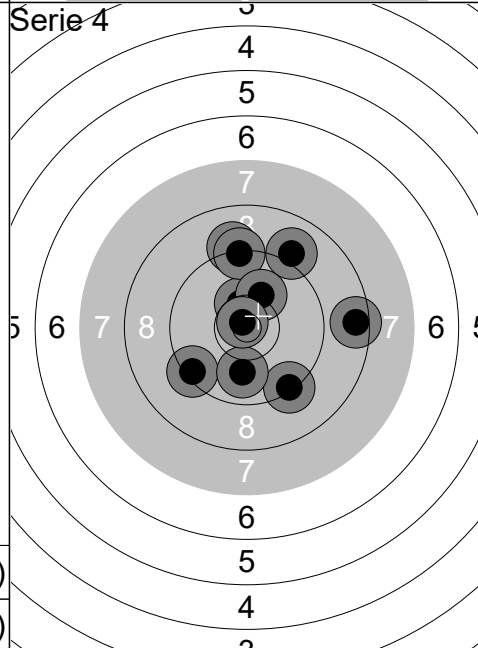

1:	9.0	↗
2:	9.1	↑
3:	8.5	⇒
4:	10.4x	↑
5:	9.3	↑
6:	9.4	↙
7:	10.1	↗
8:	9.3	↘
9:	9.9	↓
10:	10.8x	↘
Serie	92 (2x)	
Total	369 (6x)	

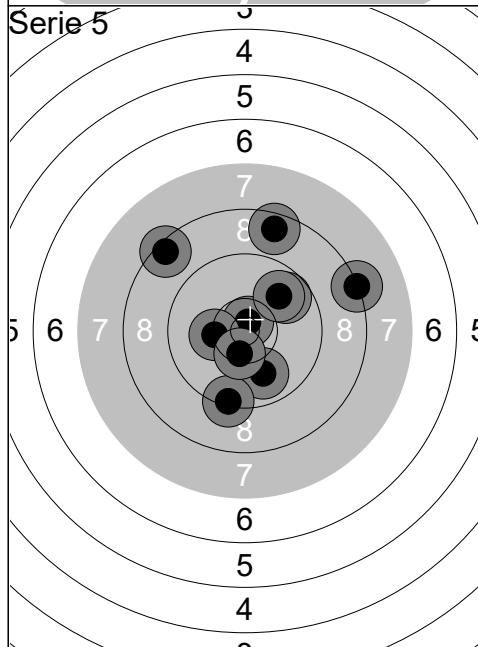

1:	10.7x	↑
2:	10.3	←
3:	8.4	↖
4:	8.6	↑
5:	9.9	↓
6:	9.3	↓
7:	9.8	↗
8:	9.9	↗
9:	8.3	⇒
10:	10.4x	↓
Serie	90 (2x)	
Total	459 (8x)	

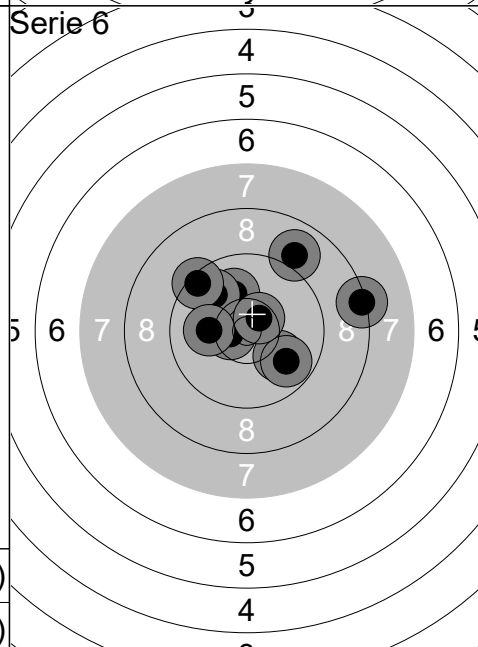

1:	10.6x	↙
2:	10.1	↑
3:	9.9	↗
4:	10.0	↘
5:	9.8	↘
6:	10.6x	↗
7:	9.0	↗
8:	8.3	⇒
9:	9.4	↖
10:	10.1	←
Serie	94 (2x)	
Total	553 (10x)	

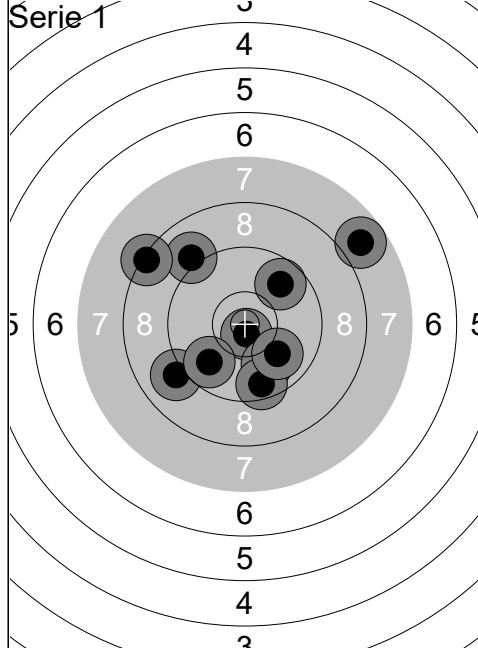

1:	7.8	↗
2:	9.0	↖
3:	9.0	↖
4:	9.7	↗
5:	10.7x	↓
6:	9.9	↓
7:	8.3	↖
8:	9.8	↖
9:	9.6	↓
10:	10.0	↘
Serie		89 (1x)
Total		89 (1x)

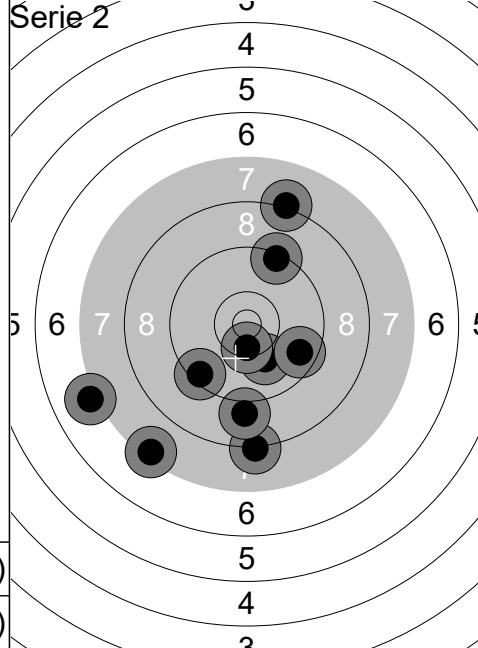

1:	7.1	↖
2:	8.2	↓
3:	10.1	↘
4:	8.2	↗
5:	7.4	↖
6:	9.6	↗
7:	9.3	↗
8:	9.0	↓
9:	10.4x	↓
10:	9.4	↖
Serie		86 (1x)
Total		175 (2x)

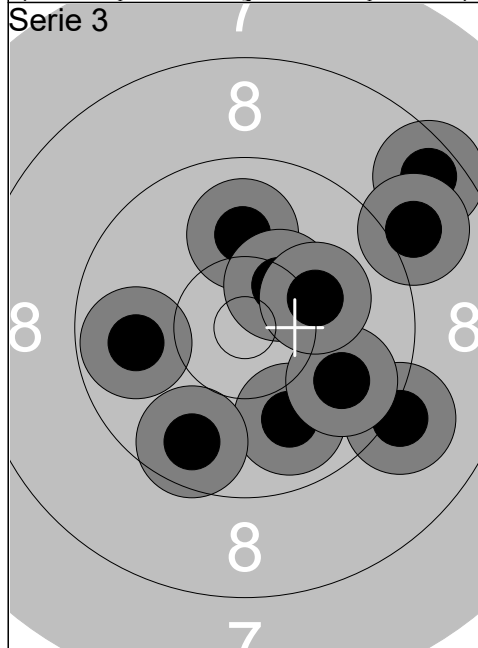

1:	9.9	↓
2:	10.0	↑
3:	9.1	↘
4:	9.8	↗
5:	8.5	↗
6:	10.4x	↗
7:	9.0	↗
8:	9.7	↓
9:	9.8	←
10:	10.2	↗
Serie		92 (1x)
Total		267 (3x)

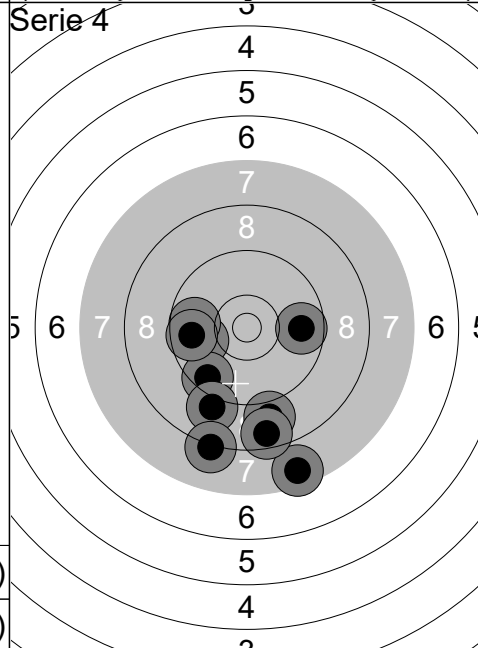

1:	9.9	←
2:	9.5	↖
3:	9.8	←
4:	9.7	←
5:	8.9	↓
6:	9.0	↓
7:	9.7	→
8:	8.2	↓
9:	7.6	↓
10:	8.5	↓
Serie		85 (0x)
Total		352 (3x)

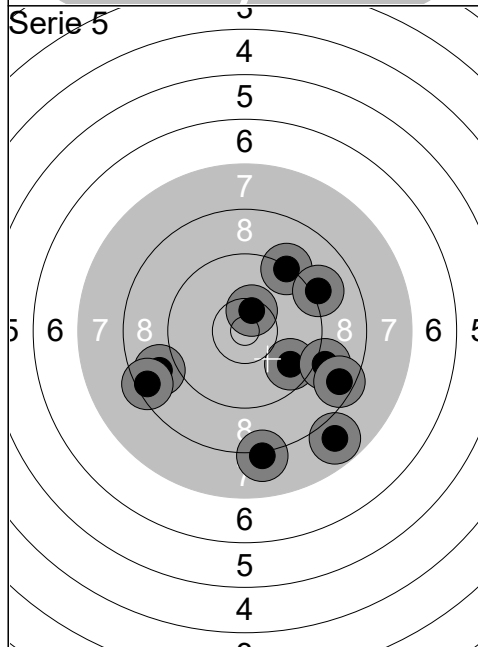

1:	8.8	←
2:	9.7	↘
3:	9.0	↗
4:	8.5	←
5:	9.3	↗
6:	10.5x	↗
7:	8.5	↘
8:	7.8	↘
9:	8.1	↓
10:	9.1	↗
Serie		85 (1x)
Total		437 (4x)

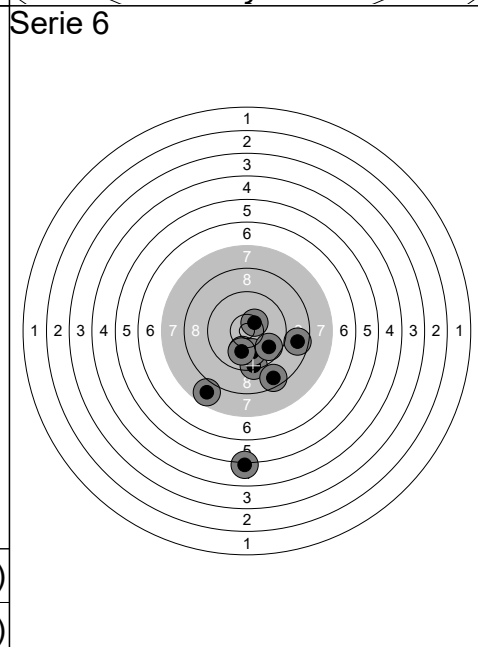

1:	10.5x	↗
2:	9.4	↓
3:	7.8	↖
4:	8.7	↗
5:	10.1	↓
6:	10.0	↓
7:	8.6	↘
8:	10.0	↓
9:	5.1	↓
10:	9.8	↘
Serie		86 (1x)
Total		523 (5x)

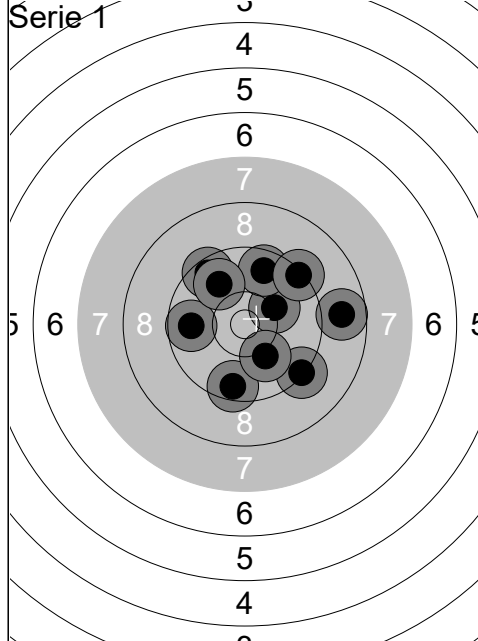

1:	9.3	↘
2:	10.2	↗
3:	9.7	←
4:	9.5	↓
5:	9.5	↗
6:	8.8	→
7:	10.1	↘
8:	9.7	↗
9:	9.9	↗
10:	9.3	↗
Serie	91 (0x)	
Total	91 (0x)	

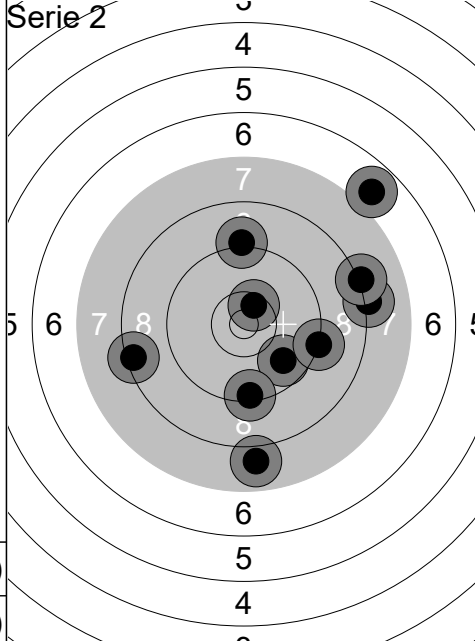

1:	9.8	↘
2:	9.1	↑
3:	9.2	→
4:	10.5x	↗
5:	8.1	→
6:	6.8	↗
7:	7.9	↓
8:	9.3	↓
9:	8.4	←
10:	8.2	→
Serie	83 (1x)	
Total	174 (1x)	

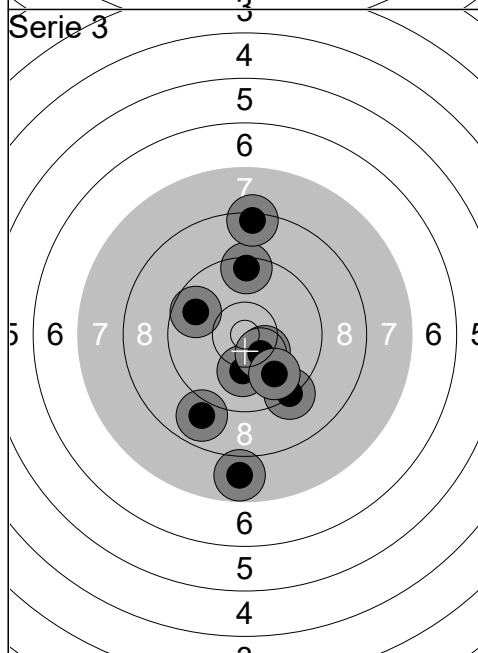

1:	10.4x	↘
2:	10.1	↓
3:	10.4x	↘
4:	8.9	↓
5:	9.3	↘
6:	9.7	←
7:	9.5	↑
8:	9.9	↘
9:	7.8	↓
10:	8.4	↑
Serie	89 (2x)	
Total	263 (3x)	

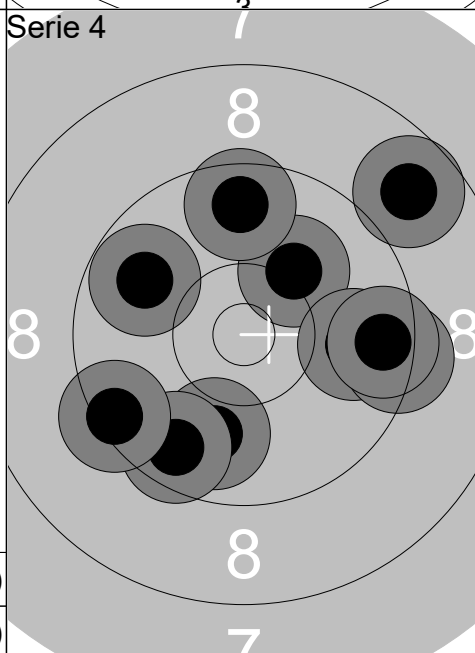

1:	9.9	↓
2:	10.1	↗
3:	9.8	→
4:	9.4	→
5:	9.5	→
6:	9.6	↓
7:	8.7	↗
8:	9.4	←
9:	9.8	←
10:	9.6	↑
Serie	90 (0x)	
Total	353 (3x)	

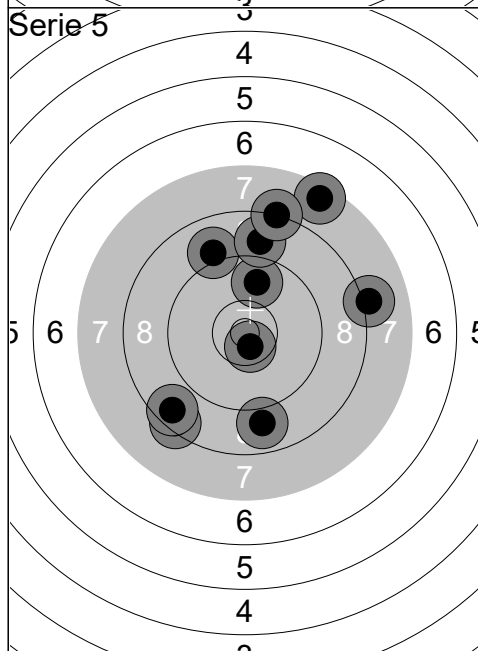

1:	8.1	→
2:	9.8	↑
3:	8.9	↓
4:	8.4	↘
5:	9.0	↗
6:	8.6	↘
7:	10.6x	↘
8:	7.5	↗
9:	8.9	↑
10:	8.2	↑
Serie	83 (1x)	
Total	436 (4x)	

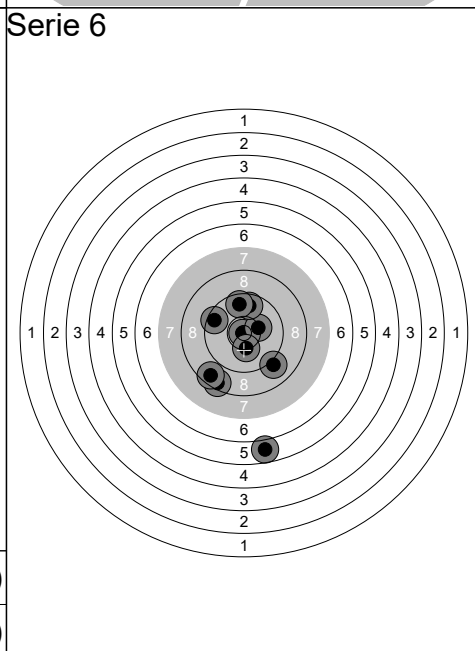

1:	10.9x	←
2:	5.8	↓
3:	8.5	↘
4:	8.6	↘
5:	10.3	→
6:	9.7	↑
7:	9.7	↑
8:	9.1	↘
9:	10.3	↓
10:	9.6	←
Serie	87 (1x)	
Total	523 (5x)	