

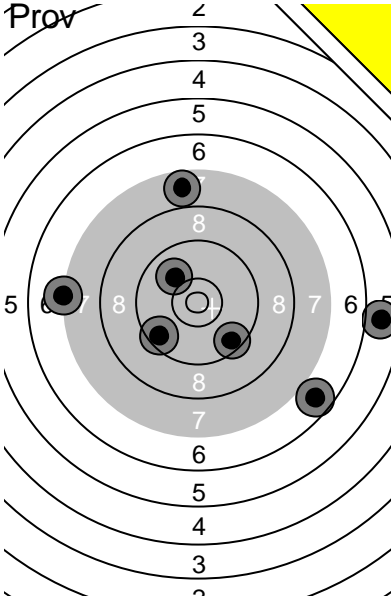
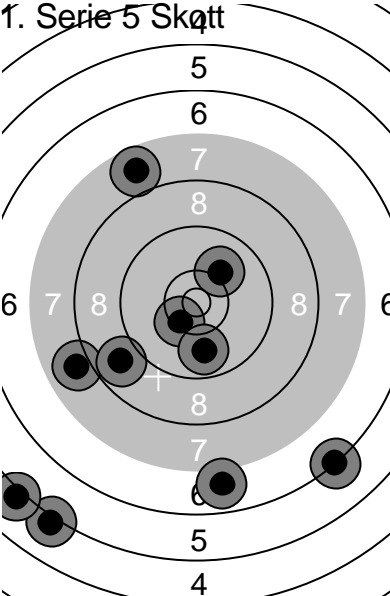
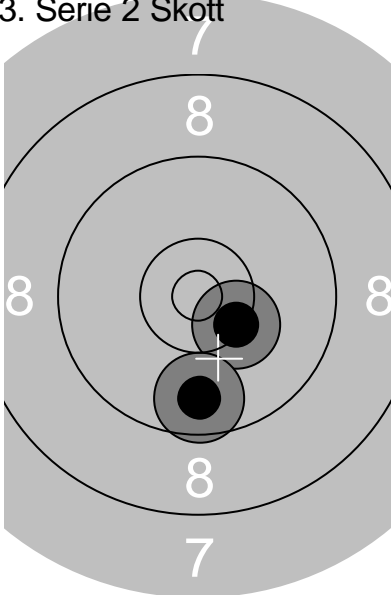
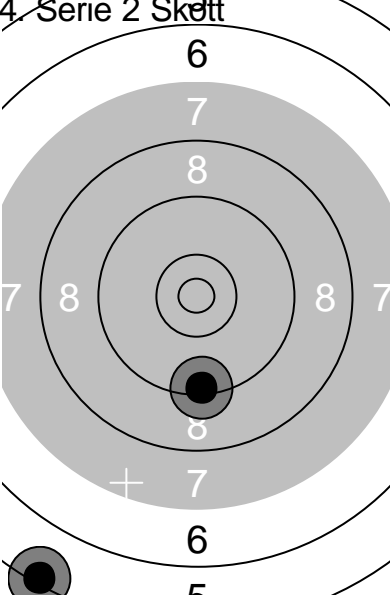
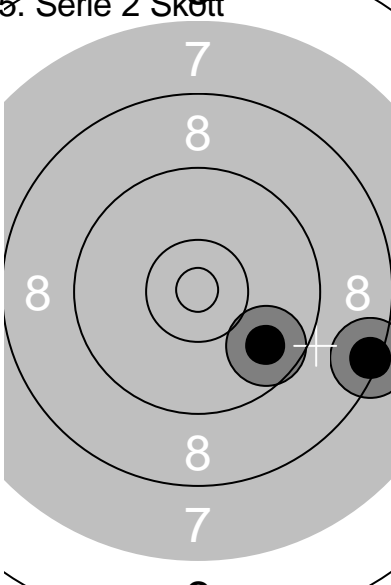

Skjutlag 1	Tavla 21	Valter Vestin		
S		Dorotea Pistolskytteklubb		
01.03.2020		RegM luftpistol 2020		Umeå skytteallians
Prov 	1: 7.5 ↓	1. Serie 5 Skott 	1: 8.6 ↗	
	2: 9.2 ↓		2: 8.4 ↓	
	3: 8.8 ↓		3: 9.0 ↙	
	4: 9.5 ↘	4: 9.6 →	4: 9.6 →	
	5: 10.3 ←	5: 8.5 ↓	5: 8.5 ↓	
	6: 8.6 ↑	6: 8.6 ↑	6: 8.6 ↑	
	7: 9.4 ↗	7: 9.7 ↓	7: 9.7 ↓	
	8: 9.5 →	8: 9.7 →	8: 9.7 →	
	9: 9.1 ↘	9: 9.1 ↑	9: 9.1 ↑	
	10: 8.5 ↓	10: 9.7 ↗	10: 9.7 ↗	
	Serie 90.4	Serie 90.9	Serie 90.9	
	Total 0.0	Total 90.9	Total 90.9	
3. Serie 2 Skött 	1: 8.2 ↗	4. Serie 2 Skött 	1: 10.5x ↘	
	2: 6.6 →		2: 8.8 ↑	
	Serie 14.8	Serie 19.3	Serie 19.3	
	Total 105.7	Total 125.0	Total 125.0	
5. Serie 2 Skött 	1: 10.0 →	6. Serie 2 Skött 	1: 9.8 ↘	
	2: 9.6 ↗		2: 9.4 ↗	
	Serie 19.6	Serie 19.2	Serie 19.2	
	Total 144.6	Total 163.8	Total 163.8	

Skjutlag 1	Tavla 22	Johan Carlson	
S	Luleå Sportskytteklubb		
01.03.2020	RegM luftpistol 2020	Umeå skytteallians	
Prov		1: 10.0 ↗ 2: 5.8 → 3: 6.8 ↘ 4: 9.5 ↘ 5: 9.5 ↙ 6: 7.7 ↑ 7: 7.2 ← Serie 56.5 Total 0.0	1. Serie 5 Skött  1: 10.1 ↗ 2: 6.9 ↓ 3: 5.1 ↘ 4: 10.4x ↘ 5: 9.9 ↓ 6: 5.1 ↘ 7: 8.0 ↙ 8: 6.2 ↘ 9: 8.8 ↙ 10: 7.7 ↗ Serie 78.2 Total 78.2
3. Serie 2 Skött	 1: 10.4x ↘ 2: 9.7 ↓ Serie 20.1 Total 98.3	4. Serie 2 Skött  1: 5.3 ↓ 2: 9.3 ↓ Serie 14.6 Total 112.9	
5. Serie 2 Skött	 1: 9.7 ↘ 2: 8.4 → Serie 18.1 Total 131.0		

Skjutlag	Tavla	Ted Granbom																																							
1	24																																								
S		Bodens Sportskytteklubb																																							
01.03.2020		RegM luftpistol 2020	Umeå skytteallians																																						
Prov		<table border="0"> <tr><td>1:</td><td>10.5x</td><td>↘</td></tr> <tr><td>2:</td><td>9.3</td><td>↙</td></tr> <tr><td>3:</td><td>9.5</td><td>↙</td></tr> <tr><td>4:</td><td>6.7</td><td>↙</td></tr> <tr><td>5:</td><td>10.3</td><td>↙</td></tr> <tr><td>6:</td><td>9.0</td><td>←</td></tr> </table>	1:	10.5x	↘	2:	9.3	↙	3:	9.5	↙	4:	6.7	↙	5:	10.3	↙	6:	9.0	←	1. Serie 5 Skott																				
1:	10.5x	↘																																							
2:	9.3	↙																																							
3:	9.5	↙																																							
4:	6.7	↙																																							
5:	10.3	↙																																							
6:	9.0	←																																							
	<table border="1"> <tr><td>Serie</td><td>55.3</td></tr> <tr><td>Total</td><td>0.0</td></tr> </table>	Serie	55.3	Total	0.0		<table border="1"> <tr><td>1:</td><td>9.8</td><td>↙</td></tr> <tr><td>2:</td><td>9.3</td><td>↖</td></tr> <tr><td>3:</td><td>9.8</td><td>↓</td></tr> <tr><td>4:</td><td>8.7</td><td>→</td></tr> <tr><td>5:</td><td>9.6</td><td>→</td></tr> <tr><td>6:</td><td>6.9</td><td>→</td></tr> <tr><td>7:</td><td>9.7</td><td>↑</td></tr> <tr><td>8:</td><td>8.4</td><td>↓</td></tr> <tr><td>9:</td><td>9.2</td><td>↖</td></tr> <tr><td>10:</td><td>9.5</td><td>←</td></tr> </table> <table border="1"> <tr><td>Serie</td><td>90.9</td></tr> <tr><td>Total</td><td>90.9</td></tr> </table>	1:	9.8	↙	2:	9.3	↖	3:	9.8	↓	4:	8.7	→	5:	9.6	→	6:	6.9	→	7:	9.7	↑	8:	8.4	↓	9:	9.2	↖	10:	9.5	←	Serie	90.9	Total	90.9
Serie	55.3																																								
Total	0.0																																								
1:	9.8	↙																																							
2:	9.3	↖																																							
3:	9.8	↓																																							
4:	8.7	→																																							
5:	9.6	→																																							
6:	6.9	→																																							
7:	9.7	↑																																							
8:	8.4	↓																																							
9:	9.2	↖																																							
10:	9.5	←																																							
Serie	90.9																																								
Total	90.9																																								
3. Serie 2 Skott		<table border="0"> <tr><td>1:</td><td>9.6</td><td>→</td></tr> <tr><td>2:</td><td>8.9</td><td>↗</td></tr> </table> <table border="1"> <tr><td>Serie</td><td>18.5</td></tr> <tr><td>Total</td><td>109.4</td></tr> </table>	1:	9.6	→	2:	8.9	↗	Serie	18.5	Total	109.4	4. Serie 2 Skott																												
1:	9.6	→																																							
2:	8.9	↗																																							
Serie	18.5																																								
Total	109.4																																								
		<table border="1"> <tr><td>Serie</td><td>20.2</td></tr> <tr><td>Total</td><td>129.6</td></tr> </table>	Serie	20.2	Total	129.6	<table border="0"> <tr><td>1:</td><td>10.8x</td><td>→</td></tr> <tr><td>2:</td><td>9.4</td><td>↑</td></tr> </table>	1:	10.8x	→	2:	9.4	↑																												
Serie	20.2																																								
Total	129.6																																								
1:	10.8x	→																																							
2:	9.4	↑																																							
5. Serie 2 Skott		<table border="0"> <tr><td>1:</td><td>8.1</td><td>↖</td></tr> <tr><td>2:</td><td>9.1</td><td>→</td></tr> </table> <table border="1"> <tr><td>Serie</td><td>17.2</td></tr> <tr><td>Total</td><td>146.8</td></tr> </table>	1:	8.1	↖	2:	9.1	→	Serie	17.2	Total	146.8	6. Serie 2 Skott																												
1:	8.1	↖																																							
2:	9.1	→																																							
Serie	17.2																																								
Total	146.8																																								
		<table border="1"> <tr><td>Serie</td><td>18.4</td></tr> <tr><td>Total</td><td>165.2</td></tr> </table>	Serie	18.4	Total	165.2	<table border="0"> <tr><td>1:</td><td>8.1</td><td>↖</td></tr> <tr><td>2:</td><td>10.3</td><td>↖</td></tr> </table>	1:	8.1	↖	2:	10.3	↖																												
Serie	18.4																																								
Total	165.2																																								
1:	8.1	↖																																							
2:	10.3	↖																																							
7. Serie 2 Skott		<table border="0"> <tr><td>1:</td><td>9.3</td><td>↗</td></tr> <tr><td>2:</td><td>9.4</td><td>↖</td></tr> </table> <table border="1"> <tr><td>Serie</td><td>18.7</td></tr> <tr><td>Total</td><td>183.9</td></tr> </table>	1:	9.3	↗	2:	9.4	↖	Serie	18.7	Total	183.9																													
1:	9.3	↗																																							
2:	9.4	↖																																							
Serie	18.7																																								
Total	183.9																																								
																																									

Skjutlag 1	Tavla 25	Tore Magnusson	
S		Gällivare Pistolklubb	
01.03.2020		RegM luftpistol 2020	Umeå skytteallians
Prov 	1: 9.3 ↗ 2: 10.5x ↗ 3: 8.4 ↗ 4: 7.9 ↗ 5: 9.0 ↘ 6: 7.5 →	1. Serie 5 Skott 	1: 9.9 → 2: 10.6x ← 3: 10.2 → 4: 9.9 ↗ 5: 8.9 → 6: 10.6x ↗ 7: 9.7 → 8: 9.2 ↗ 9: 8.7 ← 10: 7.8 ↗
	Serie 52.6 Total 0.0		Serie 95.5 Total 95.5
3. Serie 2 Skott 	1: 9.3 ← 2: 9.8 ↑	4. Serie 2 Skott 	1: 10.2 ↗ 2: 8.2 ↗
	Serie 19.1 Total 114.6		Serie 18.4 Total 133.0
5. Serie 2 Skott 	1: 9.5 ↗ 2: 8.3 ↗	6. Serie 2 Skott 	1: 9.2 ↑ 2: 9.8 ↓
	Serie 17.8 Total 150.8		Serie 19.0 Total 169.8
7. Serie 2 Skott 	1: 10.1 ↑ 2: 8.3 ←	8. Serie 2 Skott 	1: 9.5 ↑ 2: 9.7 ↗
	Serie 18.4 Total 188.2		Serie 19.2 Total 207.4

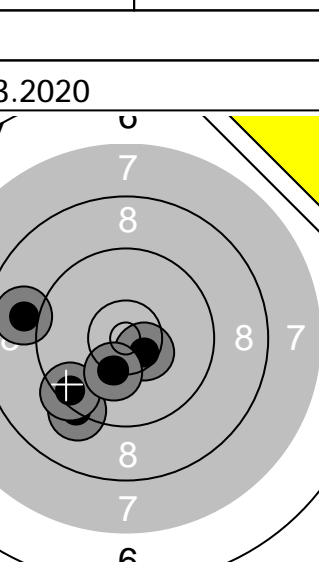
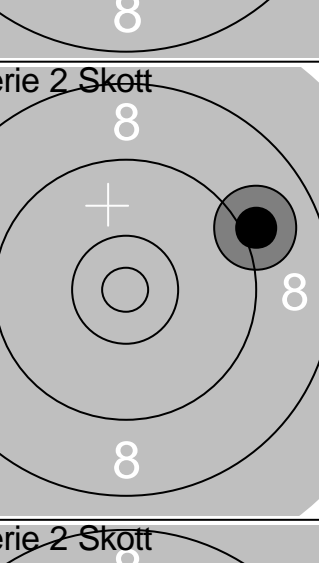
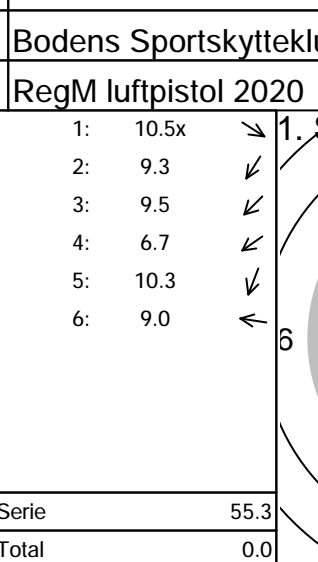
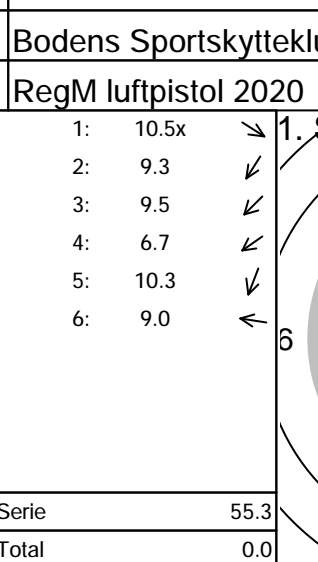
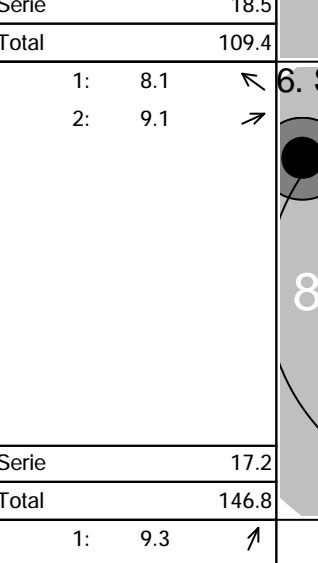
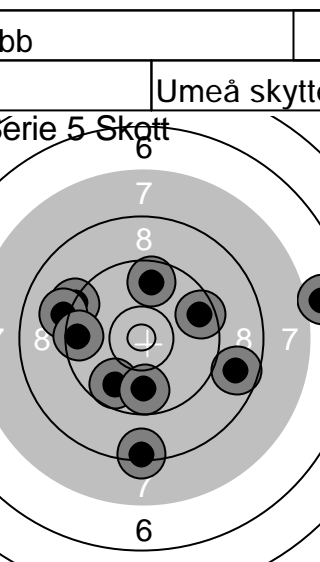
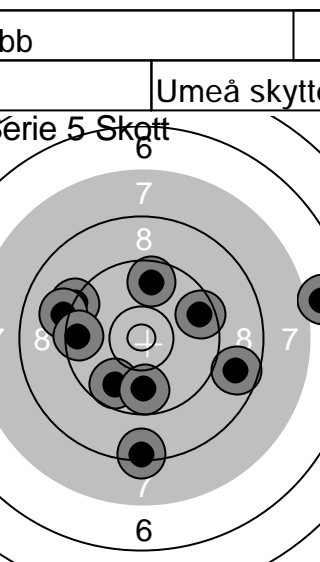
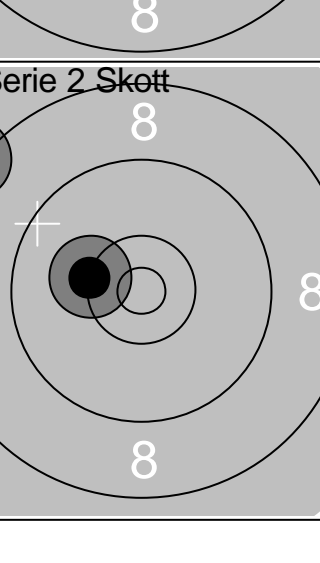
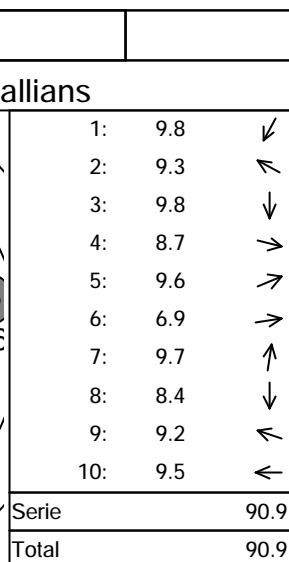
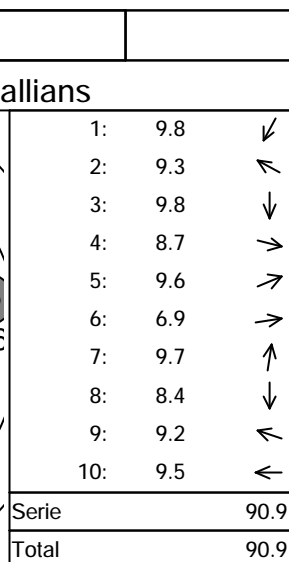
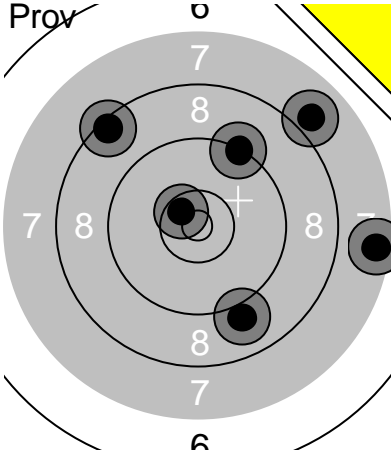
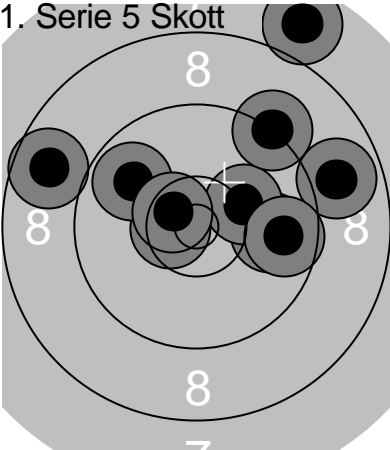
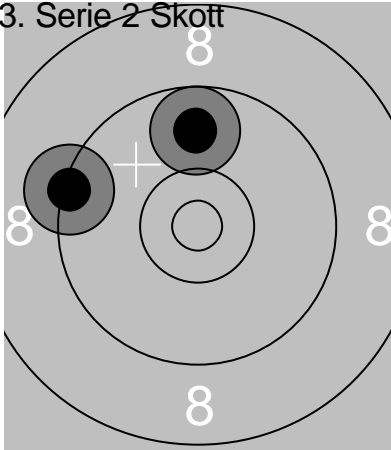
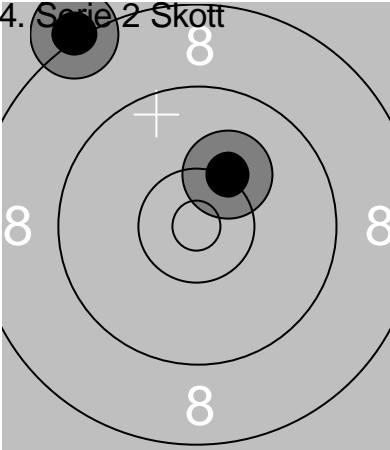
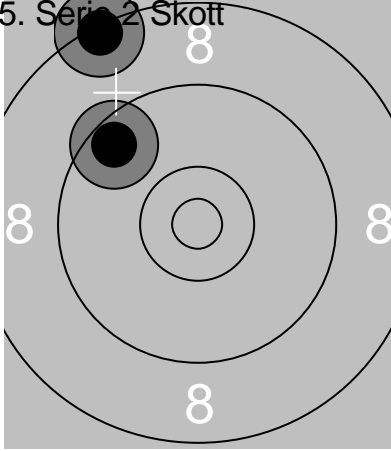
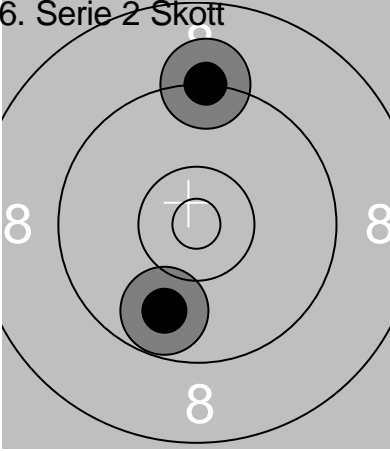
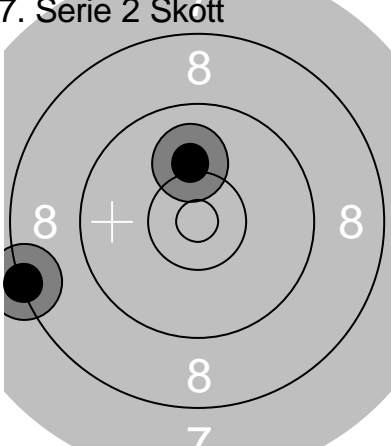
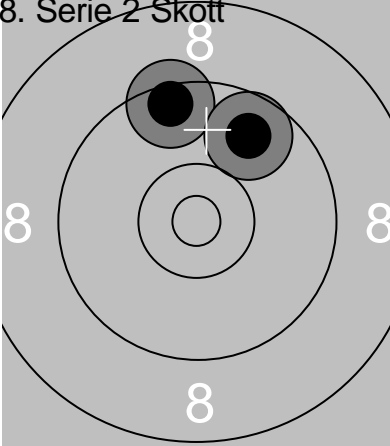
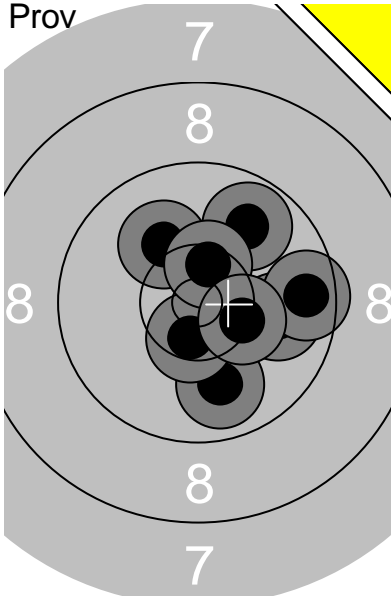
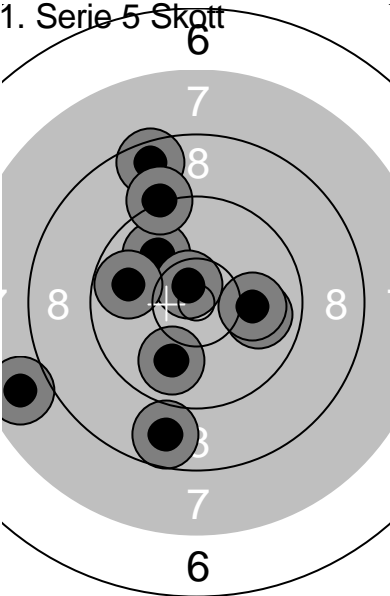
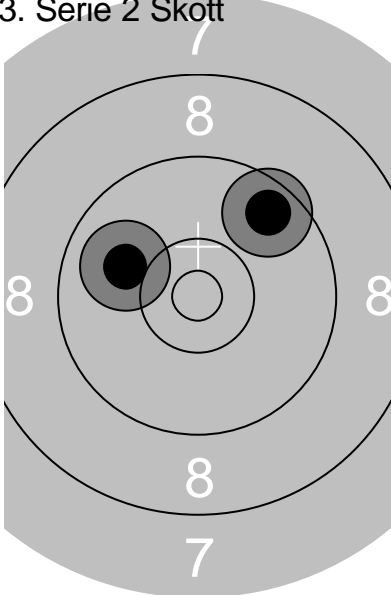
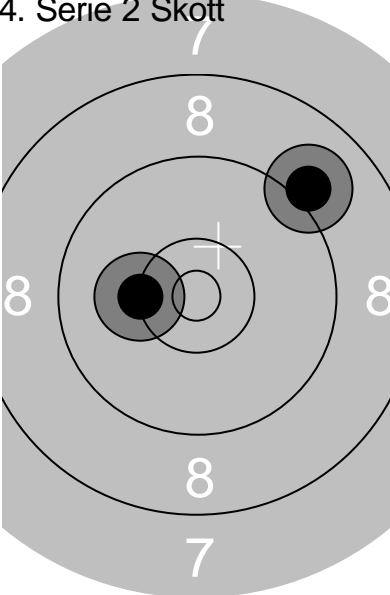
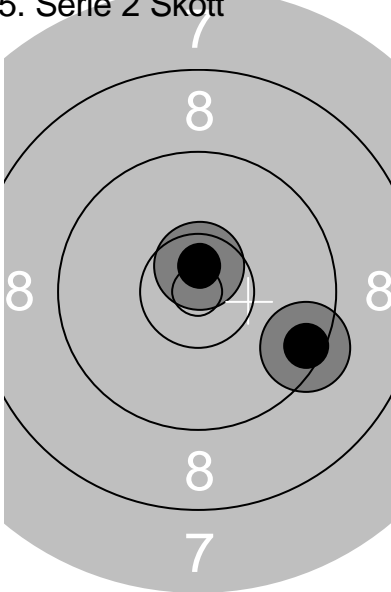
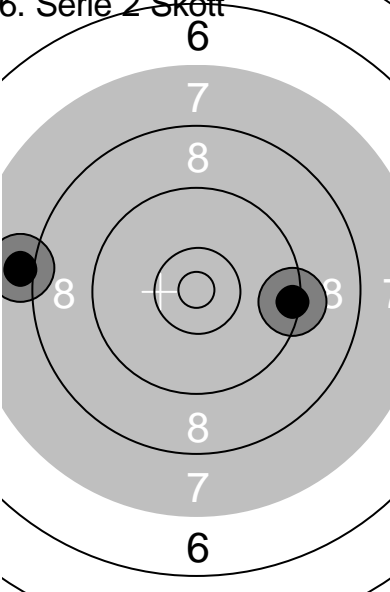
Skjutlag 1	Tavla 26	Lars Edvinsson		
S		Umeå Pistolskytteklubb		
01.03.2020		RegM luftpistol 2020		Umeå skytteallians
Prov 	1: 9.9 ↓	1. Serie 5 Skott 		1: 8.6 ↑
	2: 10.5x ↓			2: 10.0 ↖
	3: 10.1 ↗			3: 7.8 ↙
	4: 9.9 →			4: 9.9 →
	5: 9.8 ↗			5: 9.9 ↓
	6: 10.5x ↑			6: 10.6x ↗
	7: 9.6 →			7: 9.2 ↑
	8: 10.4x ⇒			8: 8.8 ↓
				9: 9.8 ←
				10: 10.0 →
	Serie 80.7			Serie 94.6
	Total 0.0			Total 94.6
3. Serie 2 Skott 	1: 9.6 ↗	4. Serie 2 Skott 		1: 9.1 ↗
	2: 10.0 ↙			2: 10.3 ←
	Serie 19.6			Serie 19.4
	Total 114.2			Total 133.6
5. Serie 2 Skott 	1: 10.7x ↑	6. Serie 2 Skott 		1: 9.4 →
	2: 9.4 ⇒			2: 8.0 ←
	Serie 20.1			Serie 17.4
	Total 153.7			Total 171.1

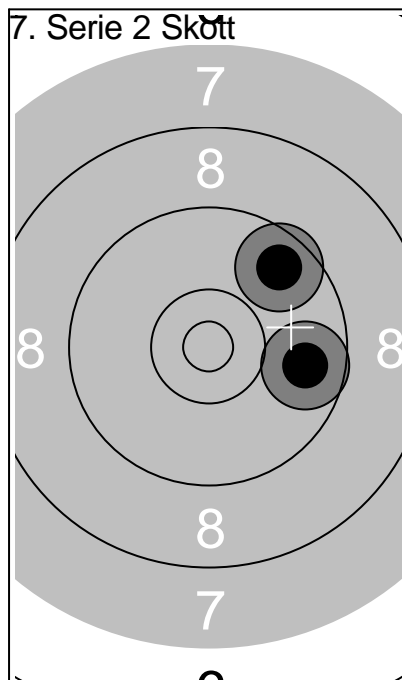

1: 9.6 ↗
2: 9.7 →

Serie	19.3
Total	190.4

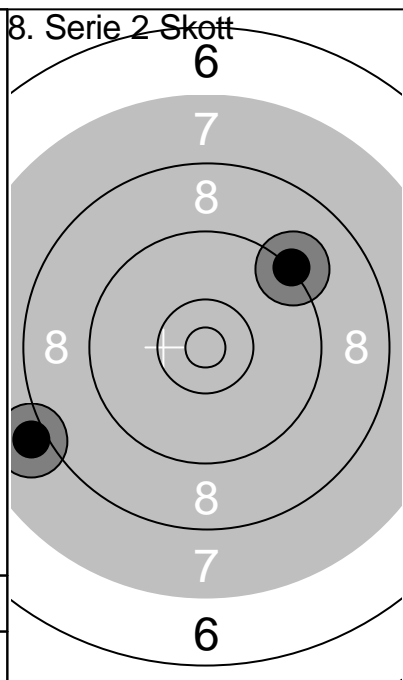

1: 8.0 ↙
2: 9.2 ↗

Serie	17.2
Total	207.6

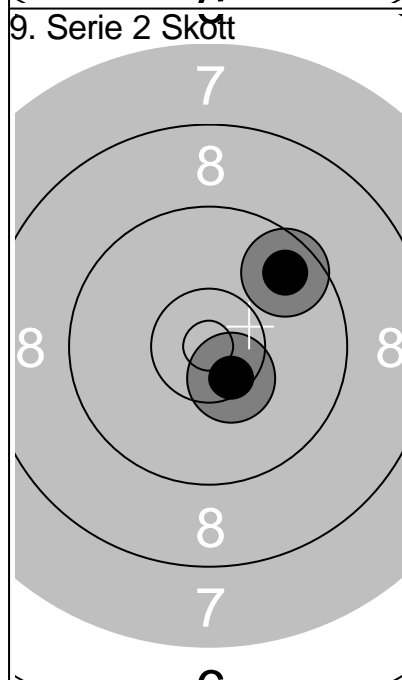

1: 9.6 ↗
2: 10.5x ↘

Serie	20.1
Total	227.7

Skjutlag 1	Tavla 27	Patrick Holmberg	
S		Kiruna Pistolskytteförening	
01.03.2020		RegM luftpistol 2020	Umeå skytteallians
Prov		1: 10.0 ↗ 2: 9.8 → 3: 10.7x ↙ 4: 10.3 ← 5: 10.6x ↗ 6: 9.0 ↓ 7: 10.5x ↘	1. Serie 5 Skott
		Serie 70.9	
		Total 0.0	1: 9.9 ↘ 2: 10.4x ↘ 3: 9.2 → 4: 9.7 ← 5: 8.4 ← 6: 9.4 ← 7: 9.2 ↗ 8: 9.6 ↙ 9: 10.2 ↙ 10: 9.3 ↗
			Serie 95.3
			Total 95.3
3. Serie 2 Skott		1: 10.7x → 2: 9.8 ↓	4. Serie 2 Skott
		Serie 20.5	
		Total 115.8	1: 8.6 ↙ 2: 8.3 ←
			Serie 16.9
			Total 132.7
5. Serie 2 Skott		1: 9.8 → 2: 9.4 ↗	6. Serie 2 Skott
		Serie 19.2	
		Total 151.9	1: 10.2 ↗ 2: 7.5 ←
			Serie 17.7
			Total 169.6

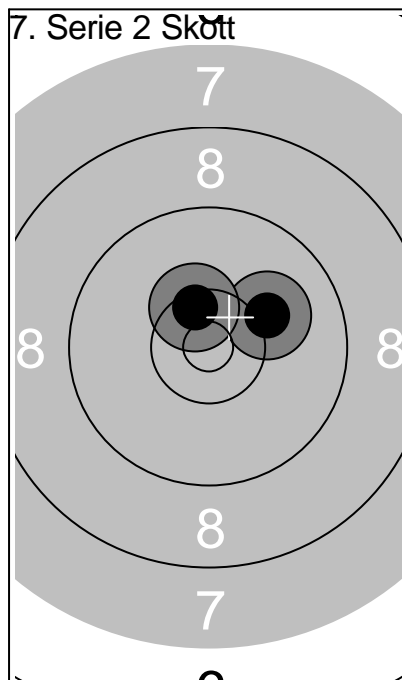

1: 10.1 ↗
2: 10.4x ↑

Serie	20.5
Total	190.1

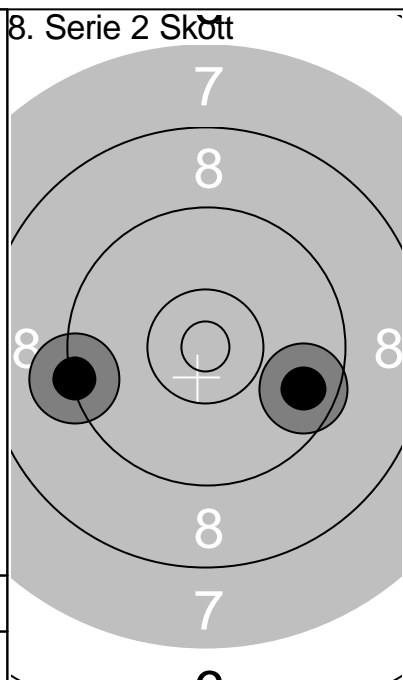

1: 9.6 ➤
2: 9.3 ←

Serie	18.9
Total	209.0

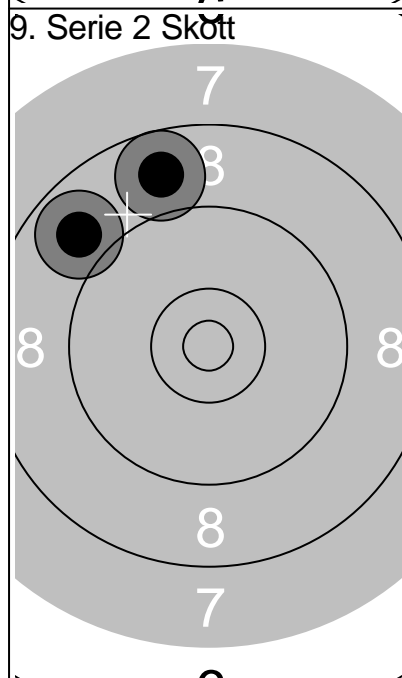

1: 8.9 ↖
2: 8.8 ↑

Serie	17.7
Total	226.7

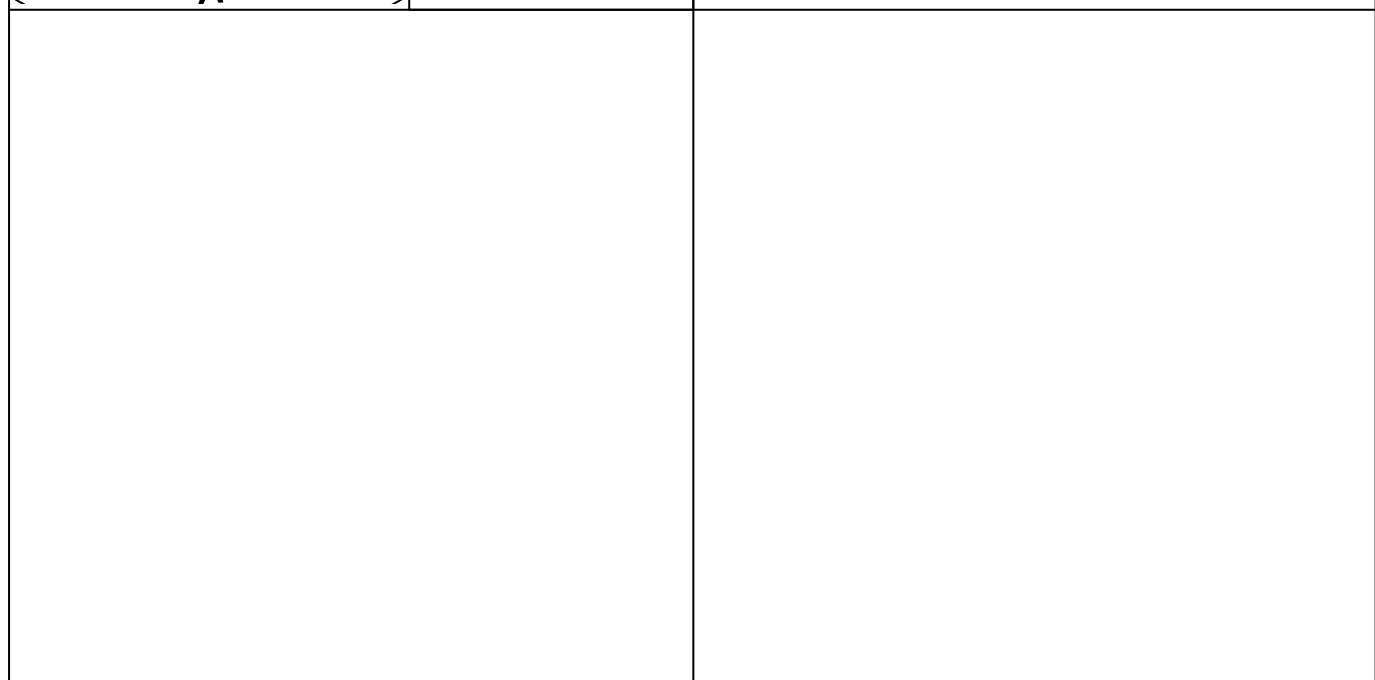

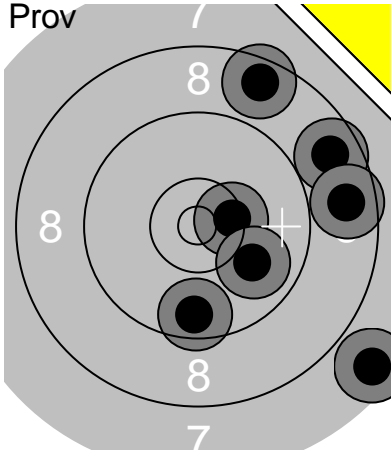
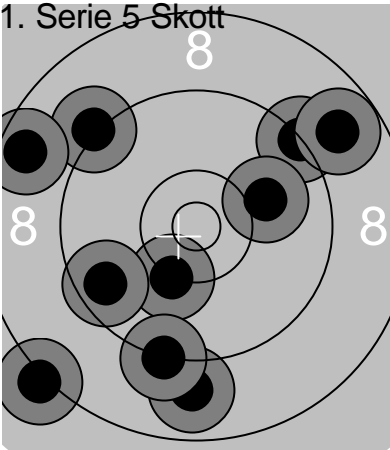
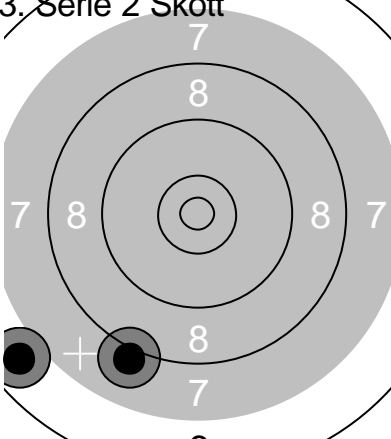
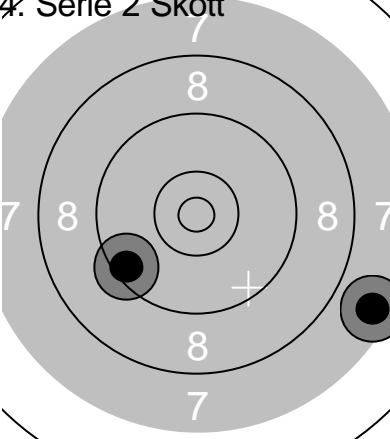
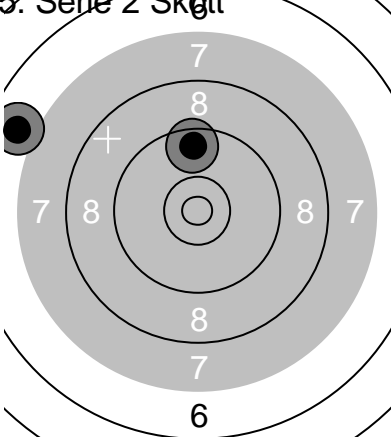
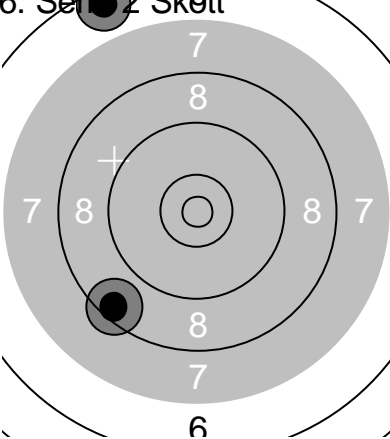
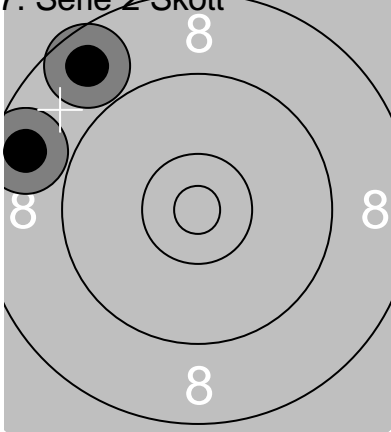
Skjutlag 1	Tavla 30	Brynolf Alexandersson	
S		Umeå Pistolskytteklubb	
01.03.2020		RegM luftpistol 2020	Umeå skytteallians
Prov 	1: 10.4x → 3: 9.6 ↓ 4: 8.7 → 5: 7.6 → 6: 8.6 ↑ 7: 10.0 ↓ 8: 8.7 →	1. Serie 5 Skott 	1: 10.2 ↓ 2: 9.2 ↖ 3: 9.6 ← 4: 9.2 ↗ 5: 8.2 ↓ 6: 8.6 ← 7: 8.9 ↓ 8: 8.8 ↗ 9: 9.2 ↓ 10: 10.0 →
	Serie 63.6 Total 0.0		Serie 91.9 Total 91.9
3. Serie 2 Skött 	1: 6.8 ↓ 2: 8.1 ↓	4. Serie 2 Skött 	1: 7.5 → 2: 9.5 ←
	Serie 14.9 Total 106.8		Serie 17.0 Total 123.8
5. Serie 2 Skött 	1: 9.6 ↑ 2: 6.9 ←	6. Serie 2 Skött 	1: 6.5 ↖ 2: 8.5 ↓
	Serie 16.5 Total 140.3		Serie 15.0 Total 155.3
7. Serie 2 Skött 	1: 8.7 ← 2: 8.7 ↗		
	Serie 17.4 Total 172.7		

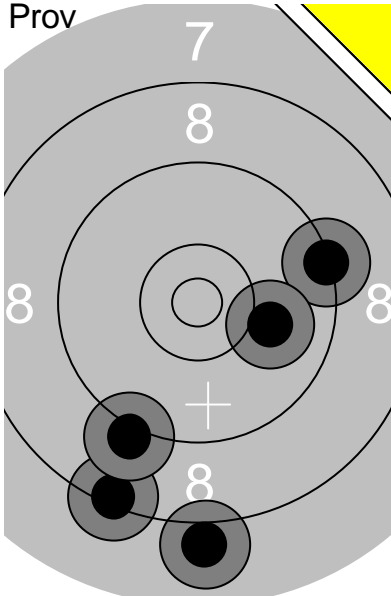
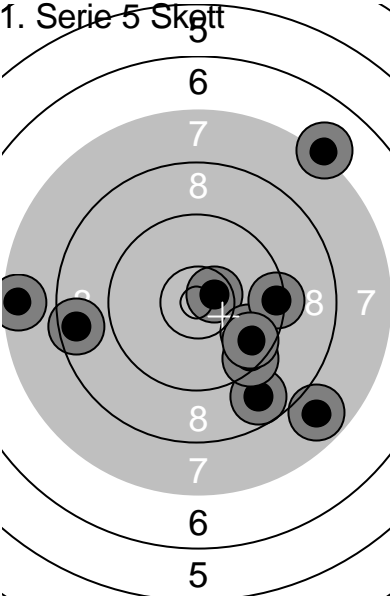
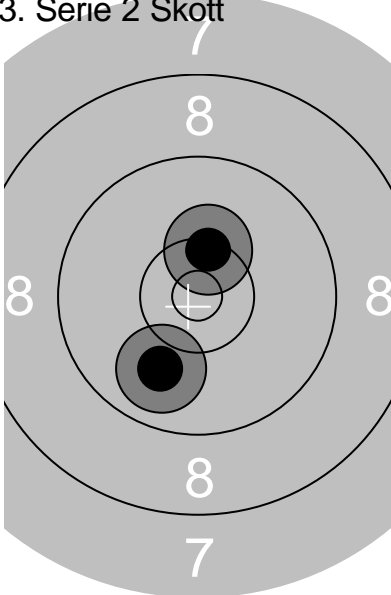
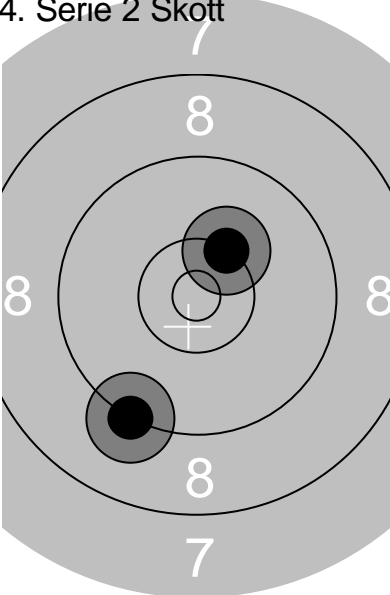
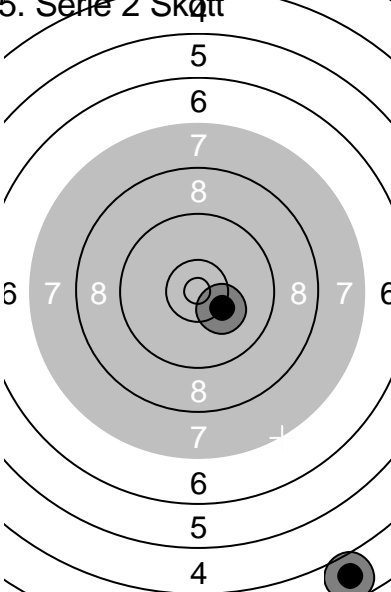
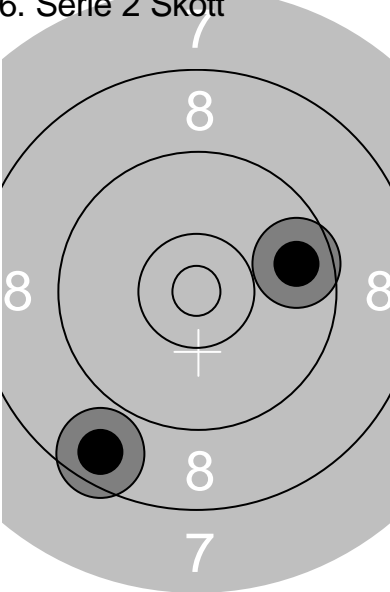
Skjutlag 1	Tavla 31	Jukka Paaso		
S		Luleå Sportskytteklubb		
01.03.2020		RegM luftpistol 2020		Umeå skytteallians
Prov 	1: 8.0 ↓	1. Serie 5 Skött 		1: 8.6 ←
	2: 9.3 →			2: 7.5 ←
	3: 8.4 ↓			3: 10.6x →
	4: 9.1 ↓			4: 9.8 →
	5: 10.0 →			5: 9.4 →
				6: 7.8 ↓
				7: 7.2 ↗
				8: 8.8 ↓
				9: 9.5 ↓
				10: 9.7 →
	Serie 44.8			Serie 88.9
	Total 0.0			Total 88.9
3. Serie 2 Skött 	1: 10.4x ↑	4. Serie 2 Skött 		1: 9.2 ↓
	2: 9.9 ↓			2: 10.3 ↗
	Serie 20.3			Serie 19.5
	Total 109.2			Total 128.7
5. Serie 2 Skött 	1: 10.3 ↘	6. Serie 2 Skött 		1: 9.7 →
	2: 3.8 ↓			2: 8.6 ↓
	Serie 14.1			Serie 18.3
	Total 142.8			Total 161.1

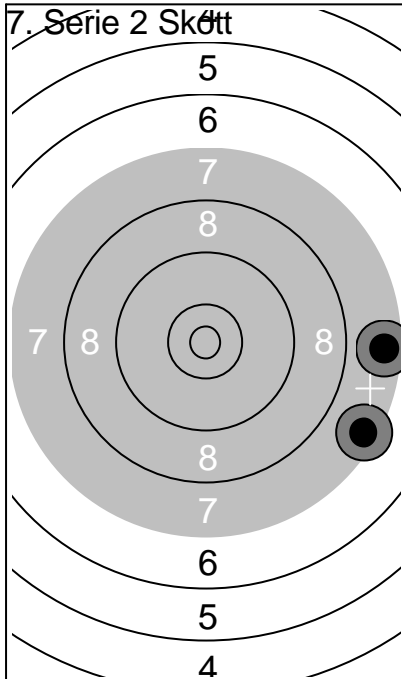

1: 7.5 →
2: 7.5 →

Serie	15.0
Total	176.1

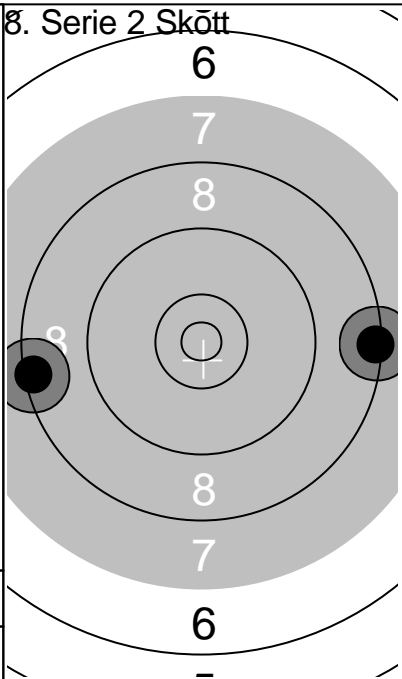

1: 8.3 →
2: 8.4 ←

Serie	16.7
Total	192.8

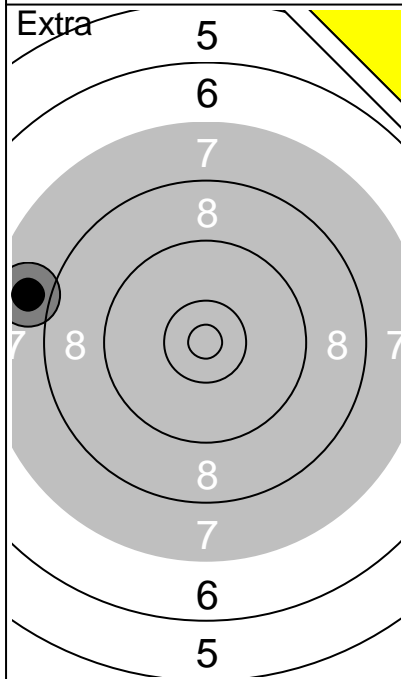

1: 7.9 ←

Serie	7.9
Total	192.8

--	--

Skjutlag 1	Tavla 32	Sven Berglund		
S		Nysätra Pistolklubb		
01.03.2020		RegM luftpistol 2020		Umeå skytteallians
Prov 	1: 9.8 ↓ 2: 10.3 ↗ 3: 10.1 ↘ 4: 8.4 ← 5: 8.0 ←	1. Serie 5 Skott 	1: 10.0 ↗ 2: 9.0 ↗ 3: 9.6 ↗ 4: 8.2 ↖ 5: 7.9 ← 6: 9.2 → 7: 6.9 ← 8: 10.0 ↓ 9: 8.0 ↑ 10: 8.2 ↗	
	Serie 46.6		Serie 87.0	
	Total 0.0		Total 87.0	
3. Serie 2 Skott 	1: 8.1 → 2: 9.1 ↗	4. Serie 2 Skott 	1: 9.9 ↘ 2: 10.0 ↘	
	Serie 17.2		Serie 19.9	
	Total 104.2		Total 124.1	
5. Serie 2 Skott 	1: 7.4 ↓ 2: 8.0 ↗	6. Serie 2 Skott 	1: 8.2 ← 2: 8.2 →	
	Serie 15.4		Serie 16.4	
	Total 139.5		Total 155.9	

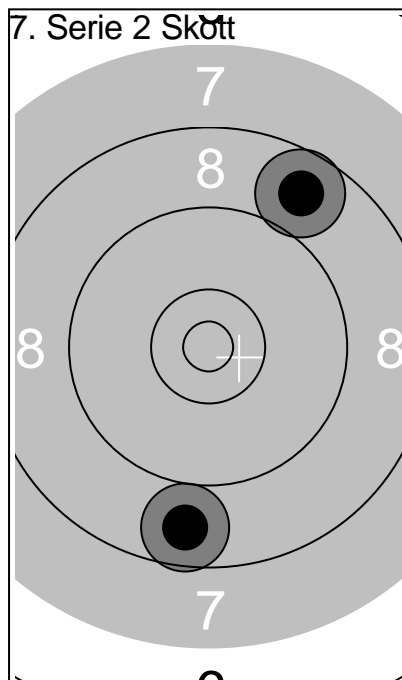

1:	8.7	↗
2:	8.7	↓
Serie		17.4
Total		173.3

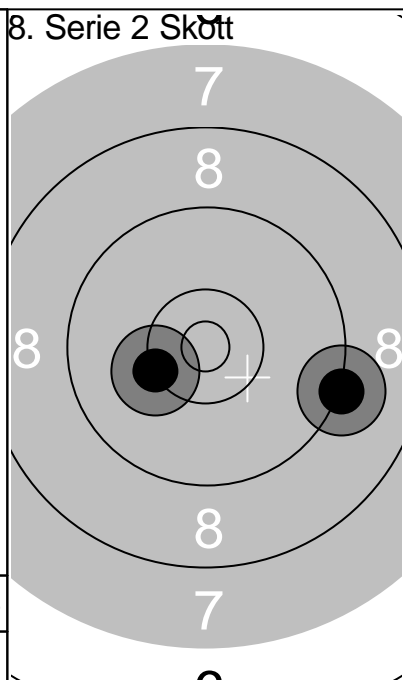

1:	9.2	→
2:	10.3	↙
Serie		19.5
Total		192.8

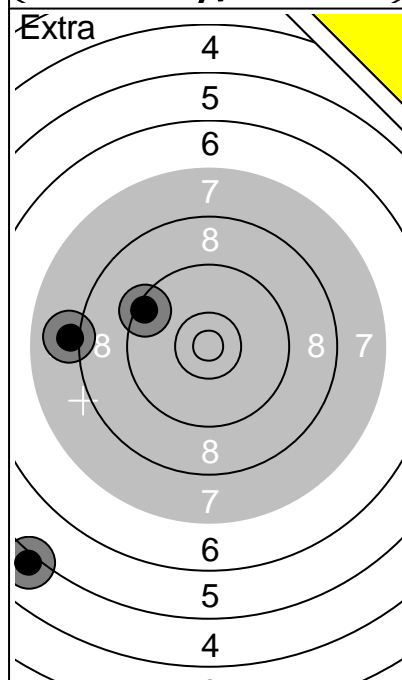

1:	8.1	←
2:	9.4	↖
3:	5.1	↙
Serie		22.6
Total		207.3

Total		173.3
-------	--	-------

Total		207.3
-------	--	-------

Skjutlag 1	Tavla 33	Conny Ström	
S		Rundviks Pistolskytteklubb	
01.03.2020		RegM luftpistol 2020	Umeå skytteallians
Prov 	1: 9.0 ↗ 2: 8.7 ↓ 3: 9.9 ↑ 4: 9.8 ← 5: 9.7 ↗ 6: 10.0 ↗ 7: 8.7 ↓ 8: 9.8 ↑	1. Serie 5 Skött 	1: 10.7x ↗ 2: 8.3 ↓ 3: 9.8 ↗ 4: 9.0 ↑ 5: 10.3 ↓ 6: 10.3 ↖ 7: 9.4 ↗ 8: 8.7 ↗ 9: 9.0 ↘ 10: 6.8 ←
	Serie 75.6		Serie 92.3
	Total 0.0		Total 92.3
3. Serie 2 Skött 	1: 10.3 ← 2: 8.7 ↗	4. Serie 2 Skött 	1: 10.4x ↗ 2: 8.5 ↓
	Serie 19.0		Serie 18.9
	Total 111.3		Total 130.2
5. Serie 2 Skött 	1: 10.7x ↗ 2: 9.8 ↓	6. Serie 2 Skött 	1: 5.1 ↗ 2: 10.3 ↓
	Serie 20.5		Serie 15.4
	Total 150.7		Total 166.1

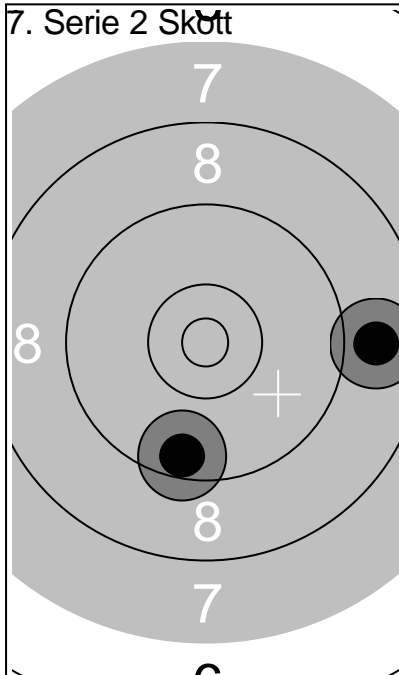

1:	8.8	→
2:	9.5	↓
Serie		18.3
Total		184.4

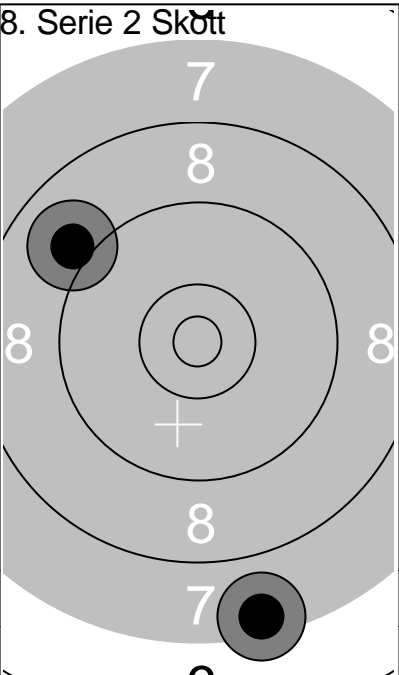

1:	7.5	↓
2:	9.0	↖
Serie		16.5
Total		200.9

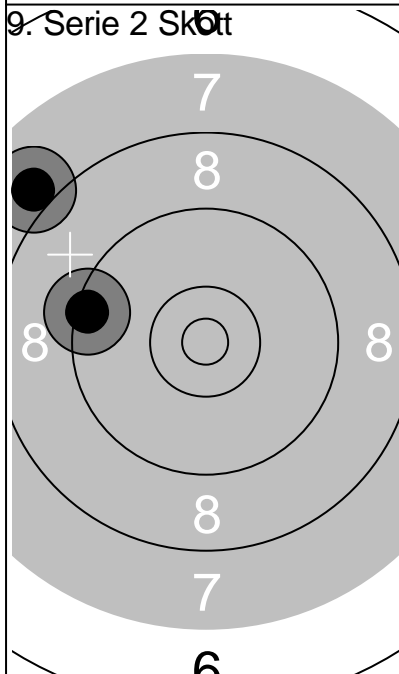

1:	9.4	←
2:	8.0	↖
Serie		17.4
Total		218.3

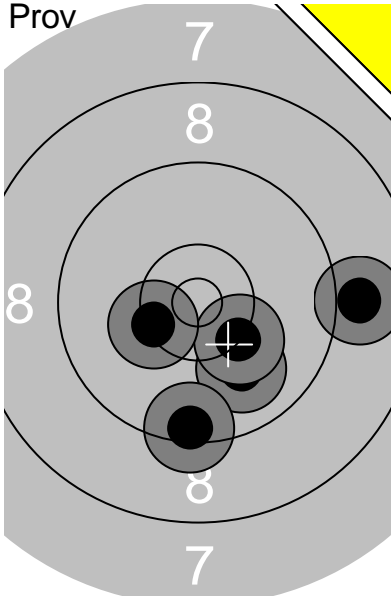
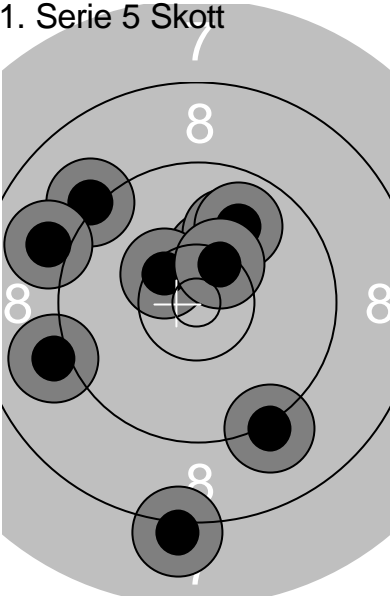
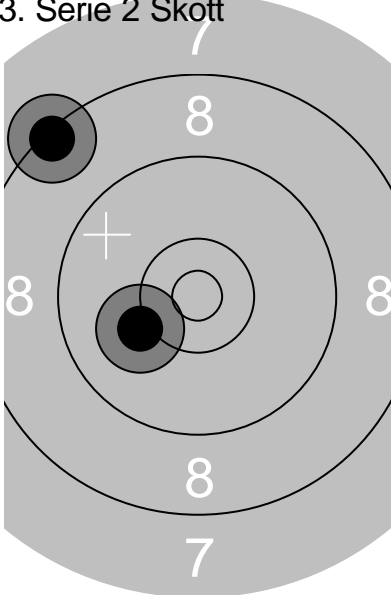
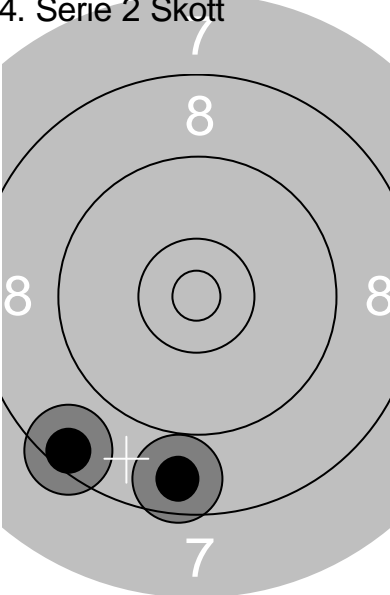
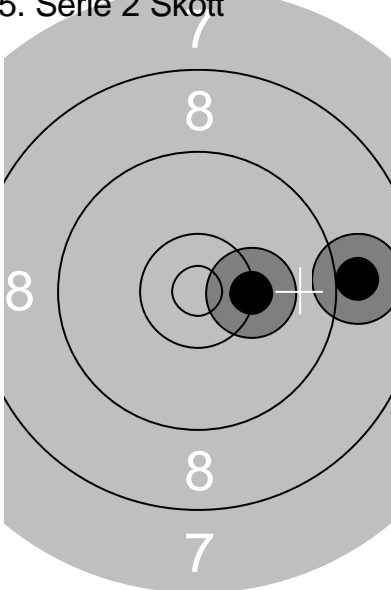
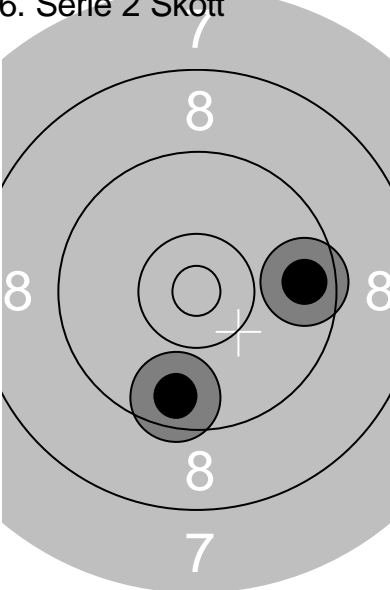
Skjutlag 1	Tavla 35	Maria Öberg	
S		Bodens Sportskytteklubb	
01.03.2020		RegM luftpistol 2020	Umeå skytteallians
Prov 	1: 10.0 ↘ 2: 10.3 ↘ 3: 9.0 → 4: 10.3 ↙ 5: 9.4 ↓	1. Serie 5 Skott 	1: 9.1 ↙ 2: 9.2 ↓ 3: 10.3 ↑ 4: 10.0 ↑ 5: 9.2 ↖ 6: 10.4x ↖ 7: 9.9 ↑ 8: 10.4x ↗ 9: 9.0 ↙ 10: 8.1 ↓
	Serie 49.0 Total 0.0		Serie 95.6 Total 95.6
3. Serie 2 Skott 	1: 8.3 ↖ 2: 10.1 ↙	4. Serie 2 Skott 	1: 8.5 ↙ 2: 8.7 ↓
	Serie 18.4 Total 114.0		Serie 17.2 Total 131.2
5. Serie 2 Skott 	1: 10.3 → 2: 9.0 →	6. Serie 2 Skott 	1: 9.6 ↓ 2: 9.6 →
	Serie 19.3 Total 150.5		Serie 19.2 Total 169.7

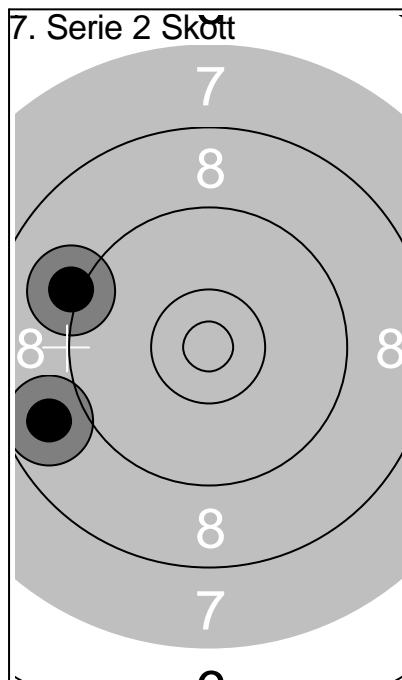

1: 8.8 ←
2: 9.1 ↙

Serie	17.9
Total	187.6

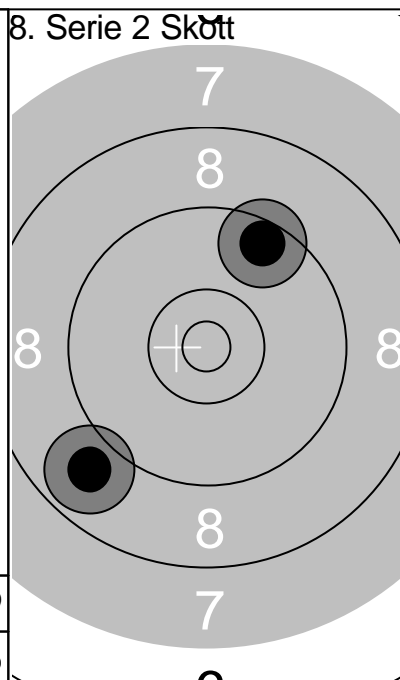

1: 9.5 ↗
2: 8.9 ↘

Serie	18.4
Total	206.0

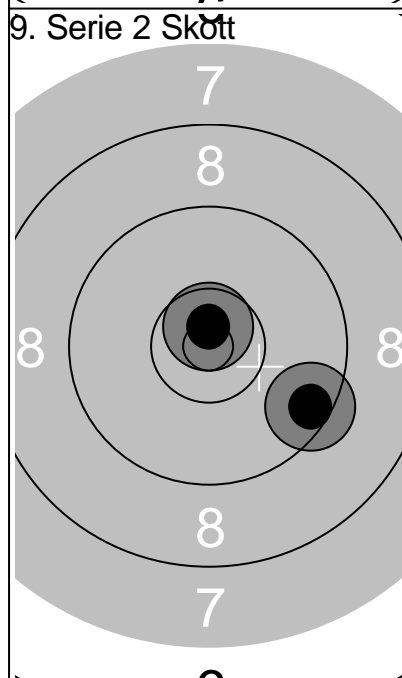

1: 10.7x ↑
2: 9.5 ↘

Serie	20.2
Total	226.2

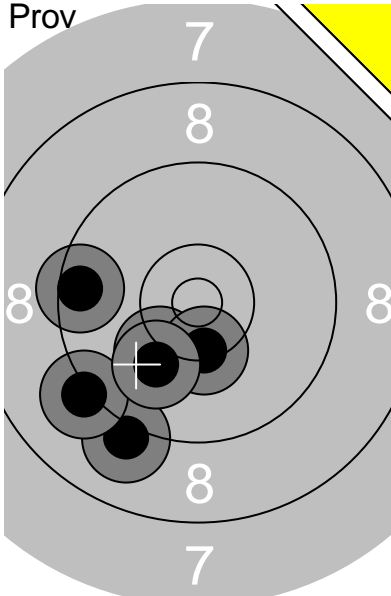
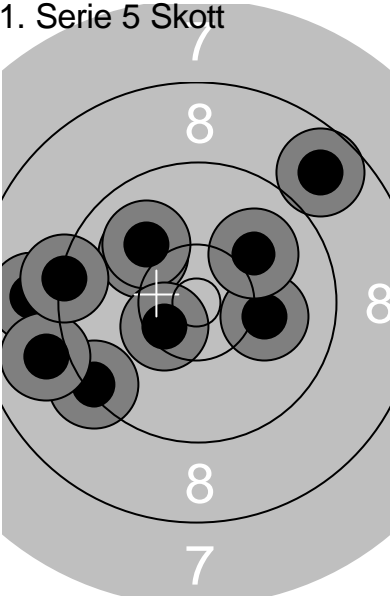
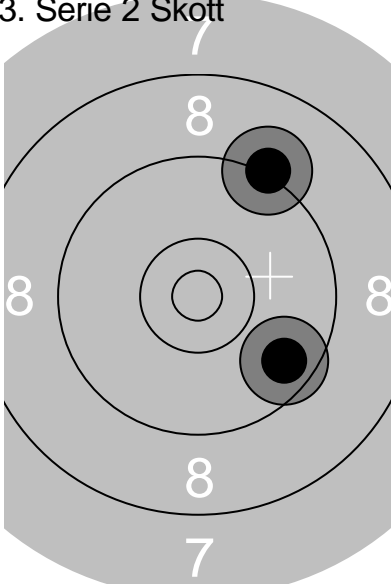
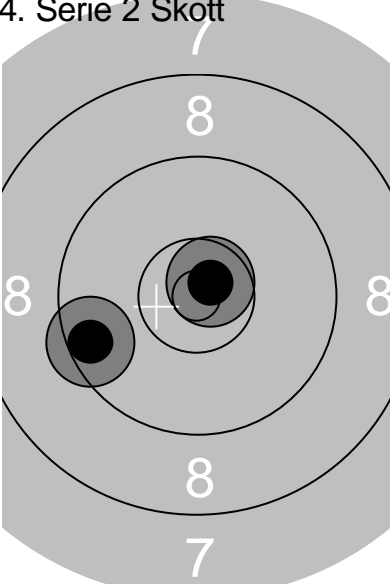
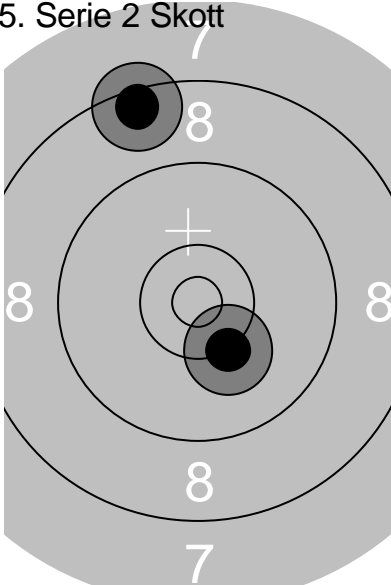
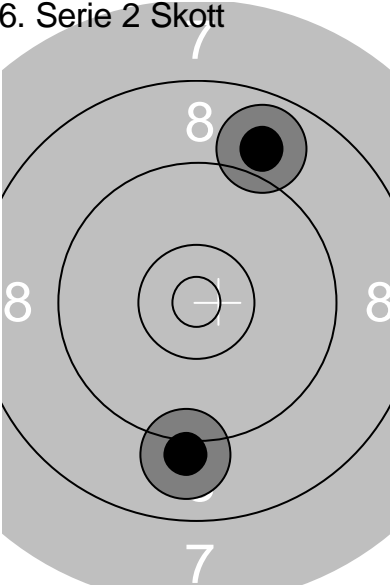
Skjutlag 1	Tavla 36	Åsa Edvinsson		
S		Umeå Pistolskytteklubb		
01.03.2020		RegM luftpistol 2020		Umeå skytteallians
Prov 	1: 9.1 ↘	1. Serie 5 Skott 	1: 8.7 ↗	
	2: 10.2 ↘		2: 10.1 ↖	
	3: 10.3 ↓		3: 10.0 ↖	
	4: 9.2 ↙		4: 10.5x ↙	
	5: 9.5 ←		5: 9.3 ↙	
	6: 10.0 ↘		6: 8.9 ←	
			7: 10.1 →	
			8: 9.0 ←	
			9: 9.3 ←	
			10: 10.0 ↗	
	Serie 58.3		Serie 95.9	
	Total 0.0		Total 95.9	
3. Serie 2 Skott 	1: 9.6 ↘	4. Serie 2 Skott 	1: 10.7x ↗	
	2: 9.2 ↗		2: 9.5 ↙	
	Serie 18.8		Serie 20.2	
	Total 114.7		Total 134.9	
5. Serie 2 Skott 	1: 10.2 ↘	6. Serie 2 Skott 	1: 8.9 ↗	
	2: 8.4 ↗		2: 9.1 ↓	
	Serie 18.6		Serie 18.0	
	Total 153.5		Total 171.5	

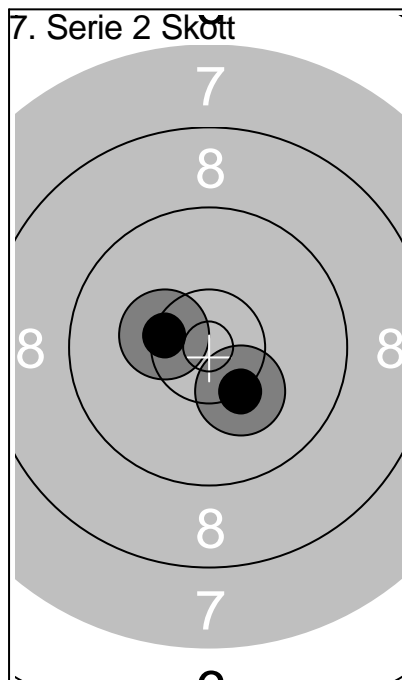

1: 10.3 ↘
2: 10.4x ←

Serie	20.7
Total	192.2

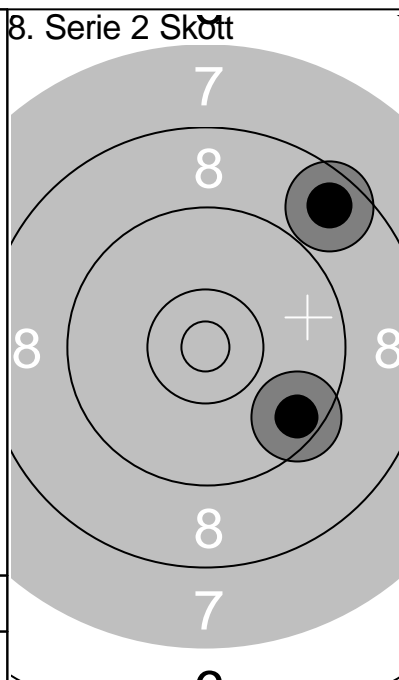

1: 8.6 ↗
2: 9.5 ↘

Serie	18.1
Total	210.3

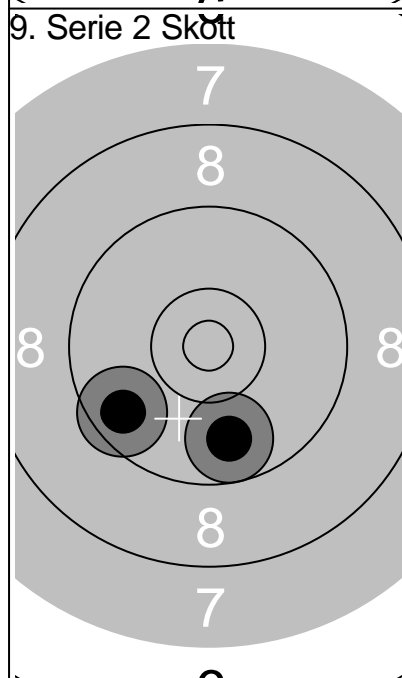

1: 9.8 ↓
2: 9.6 ↙

Serie	19.4
Total	229.7