

Skjutlag 1	Tavla 21	Lars Edvinsson			
S		Umeå Pistolskytteklubb	H 3		
29.02.2020	Final DM	Umeå skytteallians			
Prov	1: 9.1 → 2: 9.2 ↑ 3: 9.6 ← 4: 10.0 ↓ 5: 10.0 ↑ 6: 9.9 ↑ 7: 10.0 ↓ 8: 10.1 ↓ 9: 10.0 → 10: 9.5 ← Serie 97.4 Total 0.0	1. Serie 5 Skött		1: 8.5 → 2: 10.0 ↓ 3: 10.3 ↓ 4: 8.8 → 5: 9.3 ← 6: 7.2 ← 7: 10.3 ↓ 8: 10.0 ↗ 9: 9.4 ↗ 10: 10.1 ← Serie 93.9 Total 93.9	
3. Serie 2 Skött		1: 9.8 ↗ 2: 9.6 ↑ Serie 19.4 Total 113.3	4. Serie 2 Skött		1: 8.7 ↓ 2: 10.1 ↖ Serie 18.8 Total 132.1
5. Serie 2 Skött		1: 9.7 ← 2: 8.9 ← Serie 18.6 Total 150.7	6. Serie 2 Skött		1: 6.4 → 2: 8.2 ↑ Serie 14.6 Total 165.3

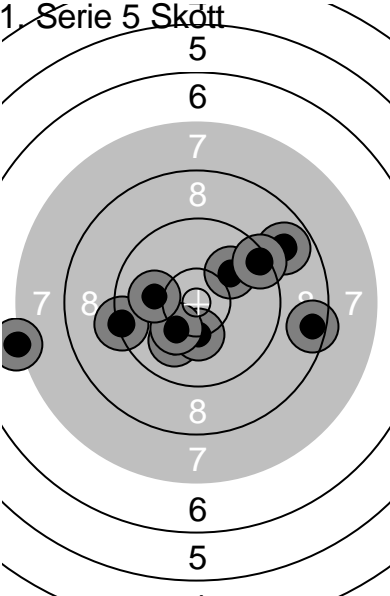

1: 9.1 ←
2: 8.5 ↗

Serie	17.6
Total	182.9

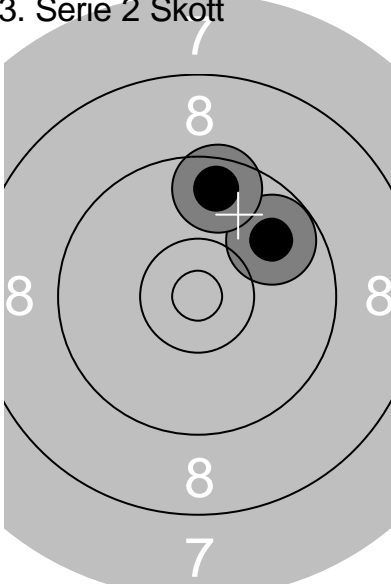
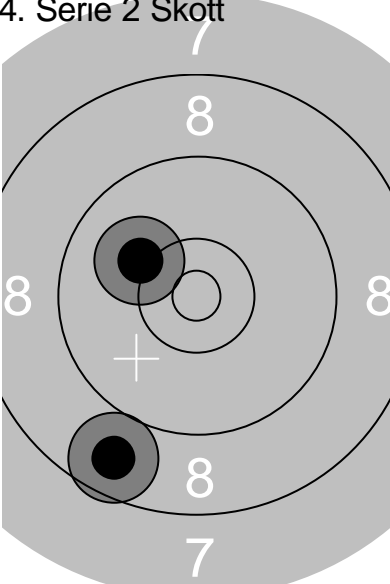
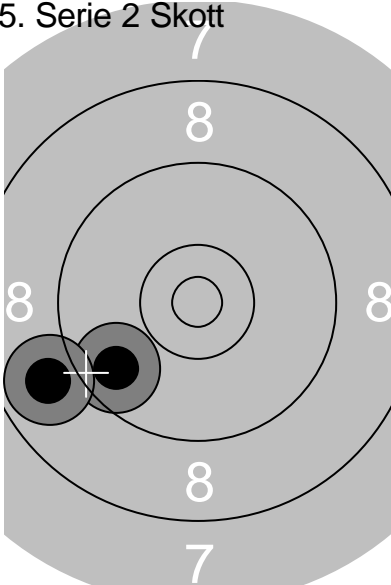
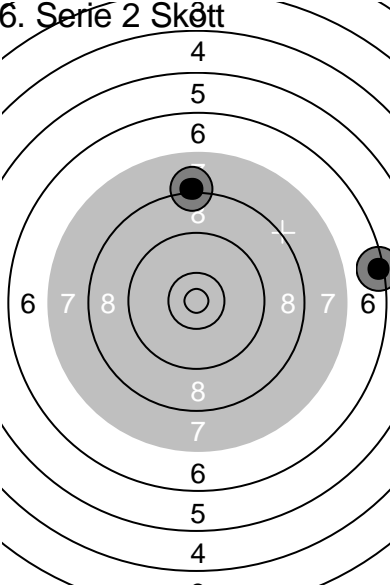
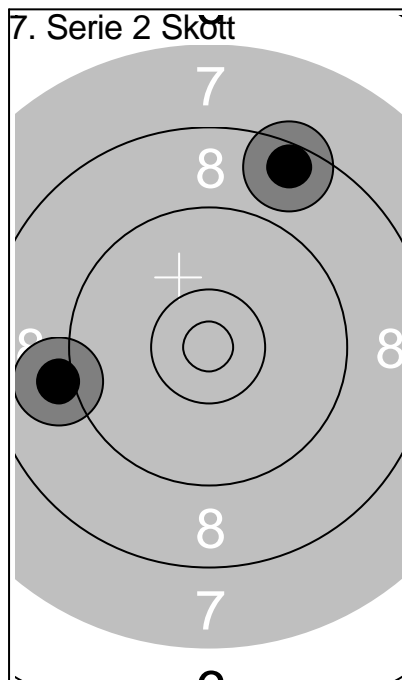
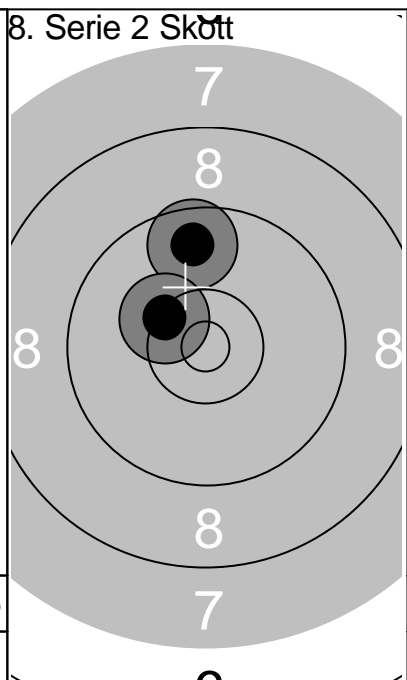

1: 9.7 ↑
2: 10.3 ↖

Serie	20.0
Total	202.9

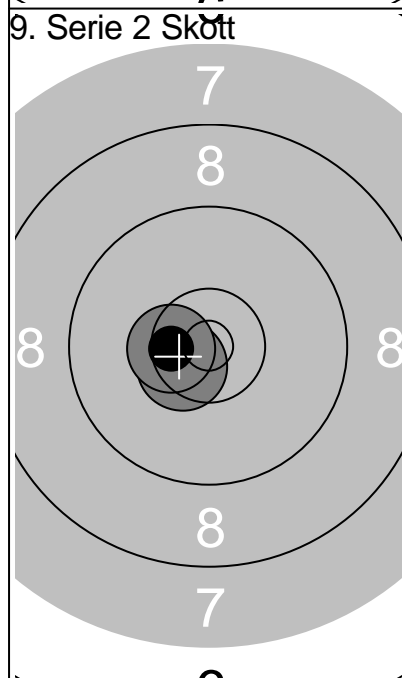

1: 10.6x ↙
2: 10.5x ←

Serie	21.1
Total	224.0

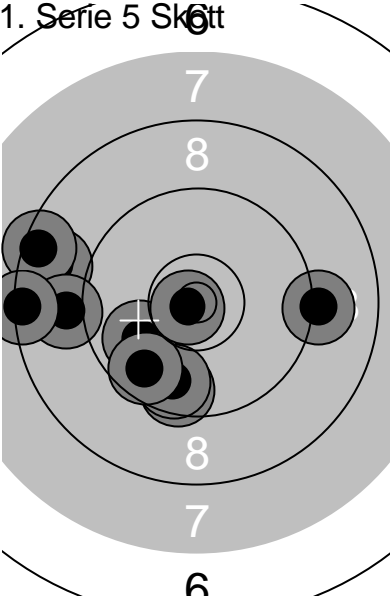
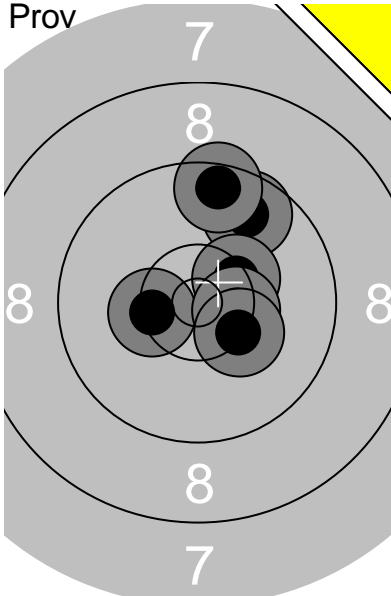
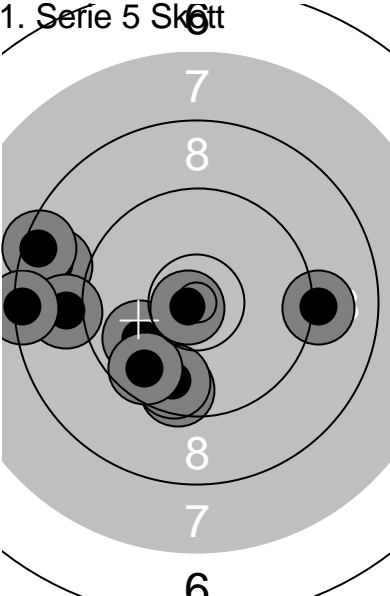
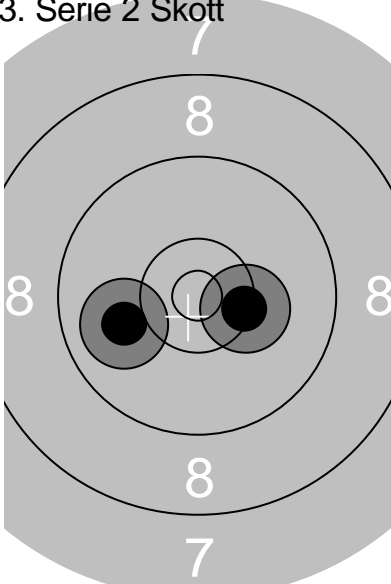
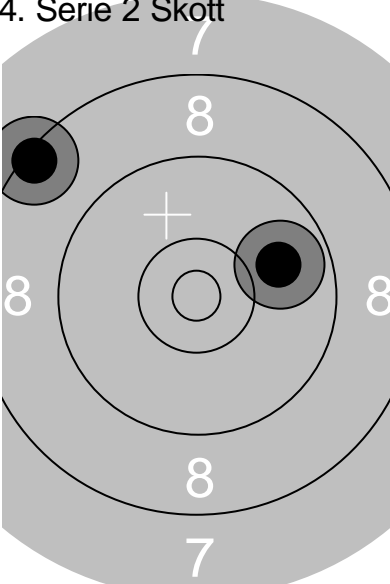
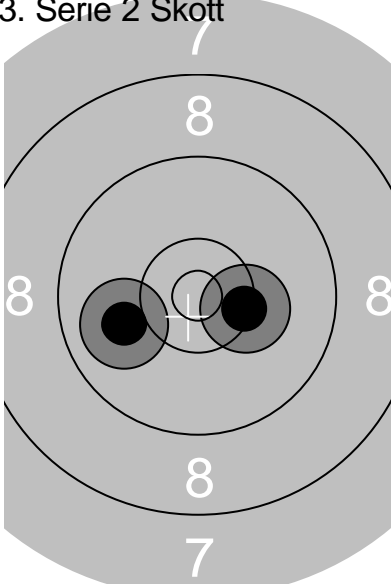
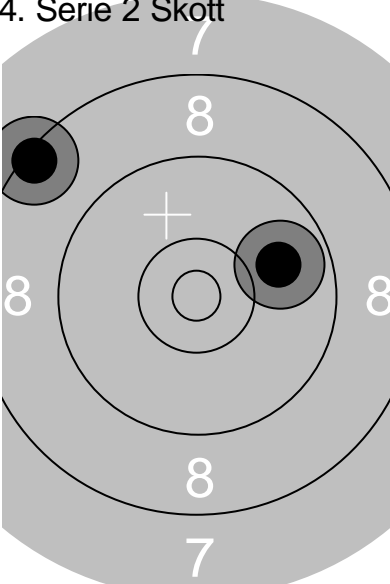
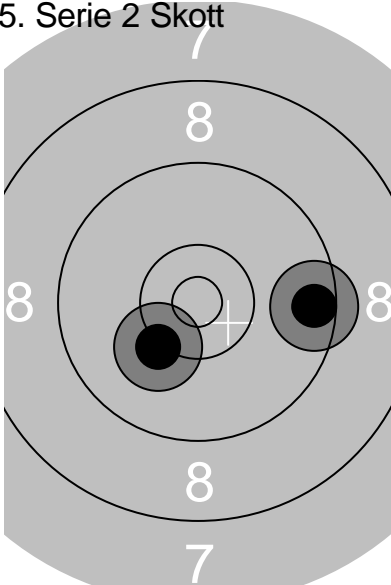
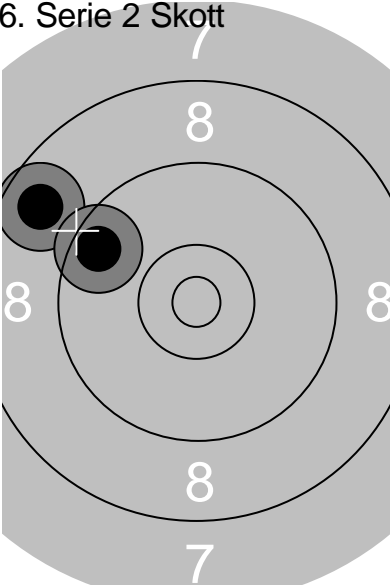
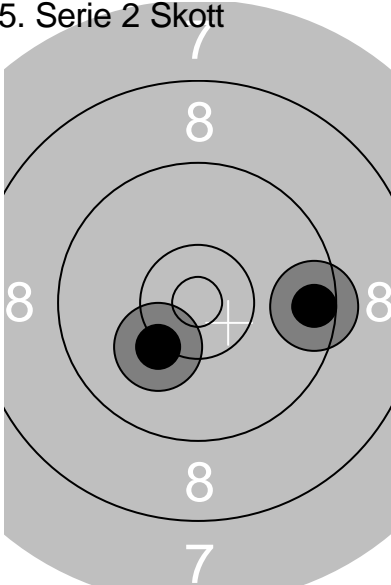
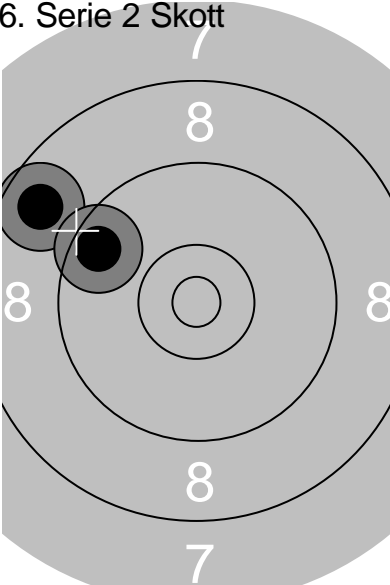
Skjutlag 1	Tavla 22	Börje Lundin	
S	Vännäs Pistolskytteklubb	H 3	
29.02.2020	Final DM	Umeå skytteallians	
Prov	1: 9.7 ↗ 2: 9.5 ↑ 3: 10.4x ← 4: 10.4x ↗ 5: 10.5x → 6: 10.3 ↘	1. Serie 5 Skott 	1: 8.8 ← 2: 9.1 → 3: 10.0 ↙ 4: 9.6 ↓ 5: 9.7 ↓ 6: 8.5 ← 7: 10.8x ↙ 8: 9.0 ← 9: 9.7 ↘ 10: 8.4 ←
	Serie 60.8 Total 0.0		Serie 93.6 Total 93.6
3. Serie 2 Skott 	1: 10.3 → 2: 10.0 ←	4. Serie 2 Skott 	1: 8.3 ↖ 2: 9.9 →
	Serie 20.3 Total 113.9		Serie 18.2 Total 132.1
5. Serie 2 Skott 	1: 9.5 → 2: 10.2 ↘	6. Serie 2 Skott 	1: 8.7 ↖ 2: 9.6 ↖
	Serie 19.7 Total 151.8		Serie 18.3 Total 170.1

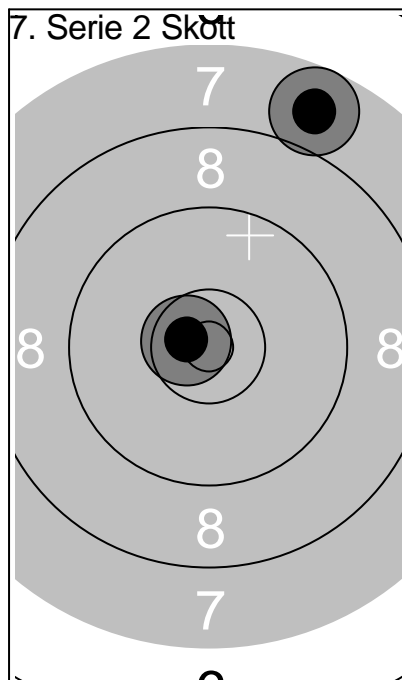

1: 10.7x ←
2: 7.8 ↗

Serie	18.5
Total	188.6

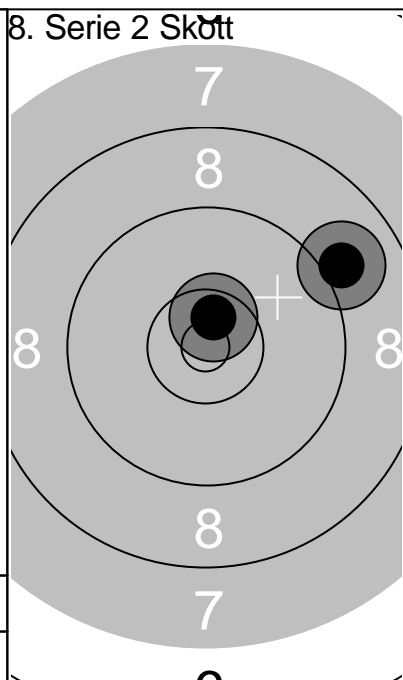

1: 10.6x ↗
2: 9.0 ↗

Serie	19.6
Total	208.2

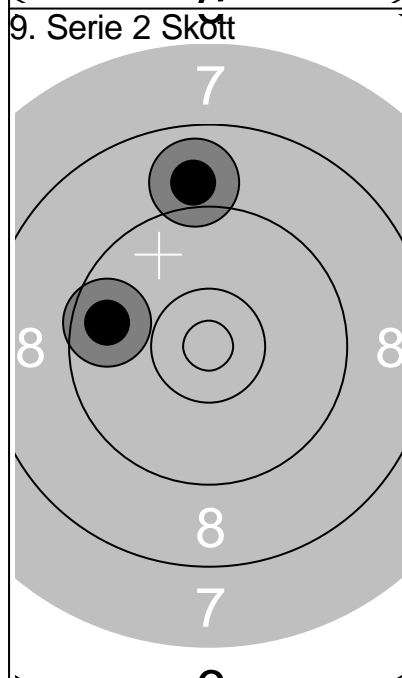

1: 8.9 ↑
2: 9.7 ←

Serie	18.6
Total	226.8

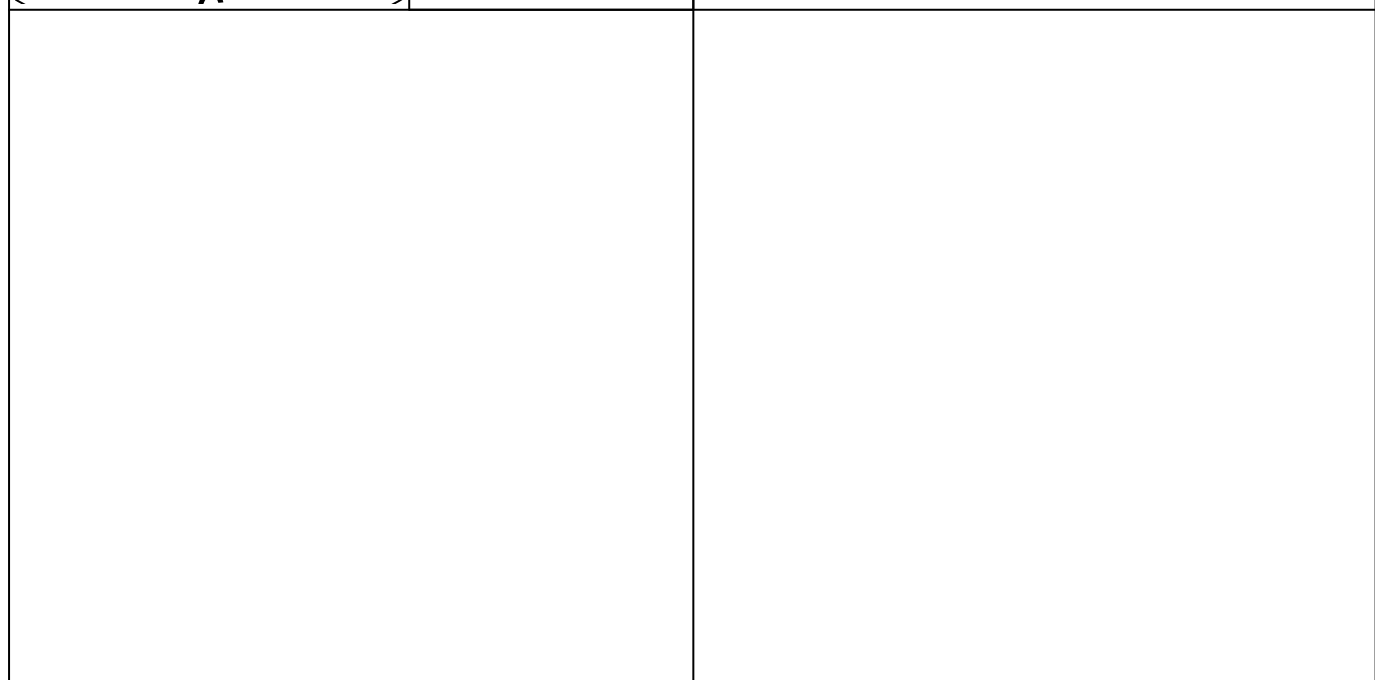

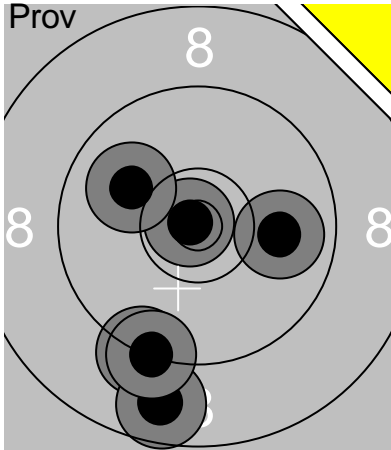
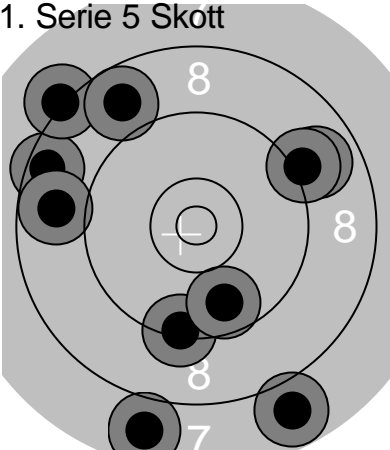
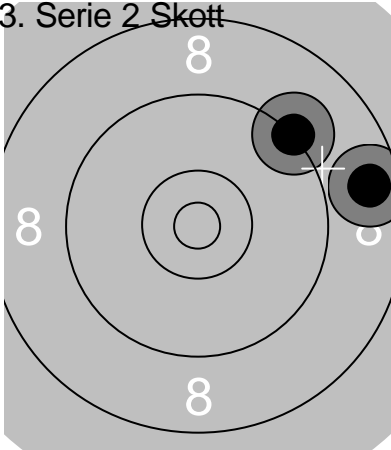
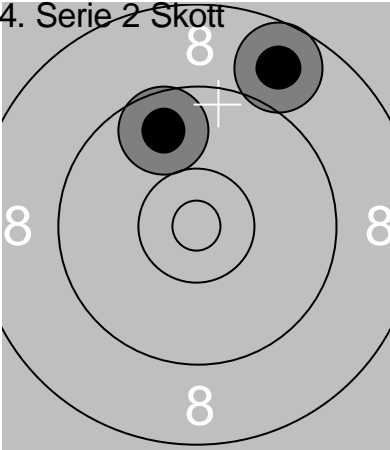
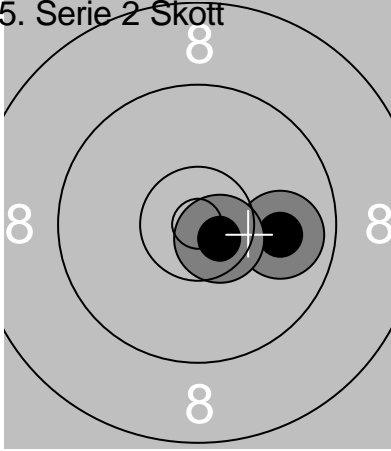
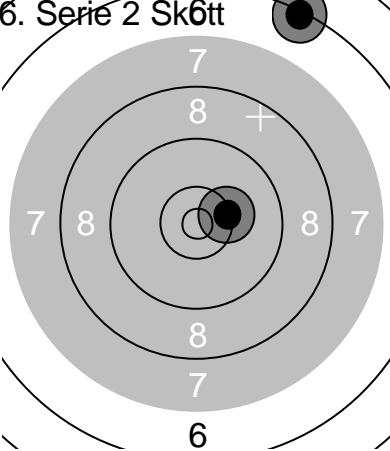
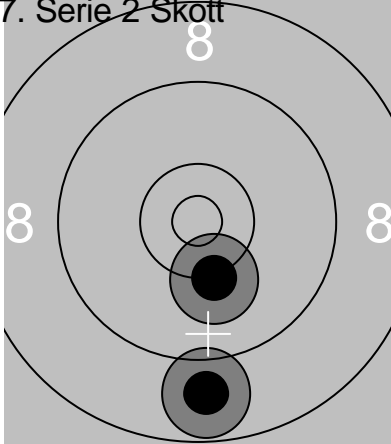
Skjutlag 1	Tavla 23	Valter Vestin	
S	Dorotea Pistolskytteklubb	H 3	
29.02.2020	Final DM	Umeå skytteallians	
Prov 	1: 9.3 ↘ 2: 10.8x ↖ 3: 8.7 ↘ 4: 10.0 ↖ 5: 9.9 → 6: 9.3 ↘ Serie 58.0 Total 0.0	1. Serie 5 Skott 	1: 8.9 ↗ 2: 9.4 ↘ 3: 9.7 ↘ 4: 7.8 ↘ 5: 9.1 ↗ 6: 8.5 ↖ 7: 8.8 ↖ 8: 8.2 ↗ 9: 8.8 ↗ 10: 7.8 ↘ Serie 87.0 Total 87.0
3. Serie 2 Skott 	1: 9.2 ↗ 2: 8.7 → Serie 17.9 Total 104.9	4. Serie 2 Skott 	1: 9.7 ↗ 2: 8.8 ↗ Serie 18.5 Total 123.4
5. Serie 2 Skott 	1: 9.9 → 2: 10.6x ↘ Serie 20.5 Total 143.9	6. Serie 2 Skott 	1: 10.3 → 2: 6.3 ↗ Serie 16.6 Total 160.5
7. Serie 2 Skott 	1: 10.2 ↘ 2: 8.8 ↘ Serie 19.0 Total 179.5		

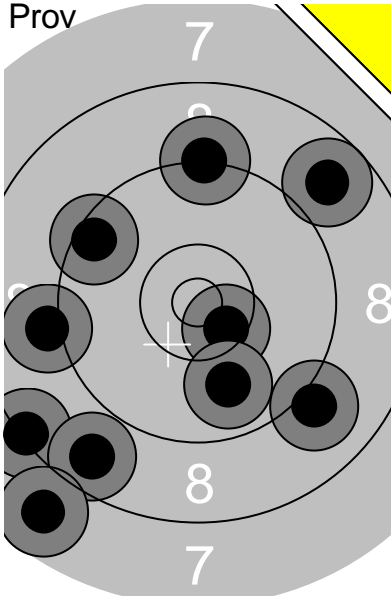
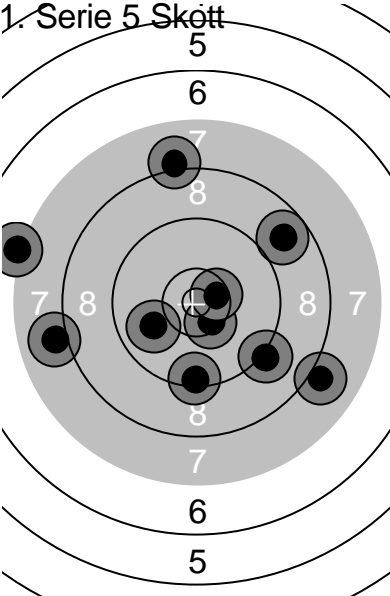
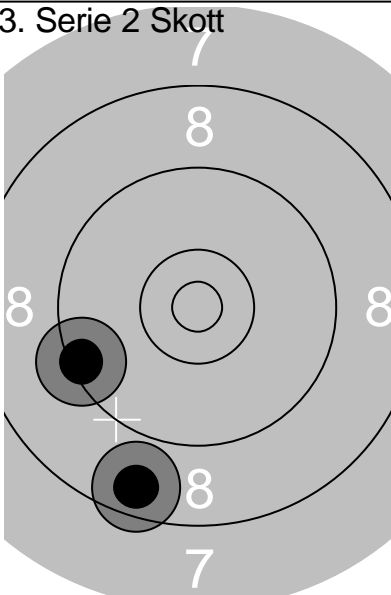
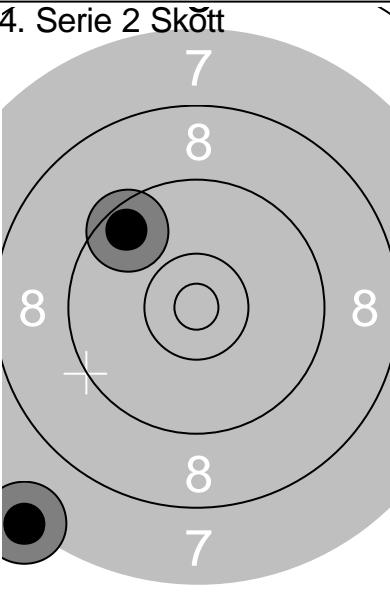
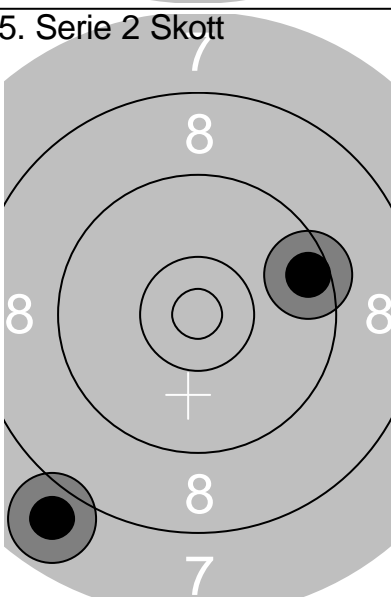
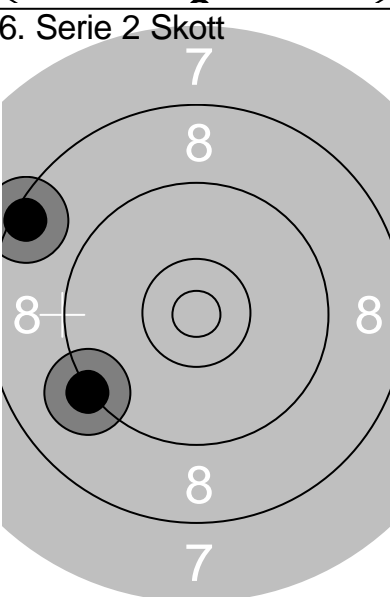
Skjutlag 1	Tavla 24	Sven Berglund	
S	Nysätra Pistolklubb	H 3	
29.02.2020	Final DM	Umeå skytteallians	
Prov 	1: 10.5x ↘ 2: 8.3 ↙ 3: 8.8 ↗ 4: 9.0 ↘ 5: 8.7 ↘ 6: 9.5 ↖ 7: 9.1 ← 8: 9.9 ↘ 9: 7.8 ↘ 10: 9.2 ↑ Serie 90.8 Total 0.0	1. Serie 5 Skött 	1: 7.2 ↖ 2: 9.4 ↓ 3: 10.5x ↘ 4: 10.5x → 5: 9.2 ↘ 6: 9.9 ↖ 7: 8.1 ↑ 8: 8.0 ← 9: 8.0 ↘ 10: 8.8 ↗ Serie 89.6 Total 89.6
3. Serie 2 Skött 	1: 9.4 ↖ 2: 8.6 ↓ Serie 18.0 Total 107.6	4. Serie 2 Skött 	1: 9.6 ↗ 2: 7.2 ↘ Serie 16.8 Total 124.4
5. Serie 2 Skött 	1: 9.5 → 2: 7.9 ↘ Serie 17.4 Total 141.8	6. Serie 2 Skött 	1: 8.4 ↖ 2: 9.2 ↖ Serie 17.6 Total 159.4

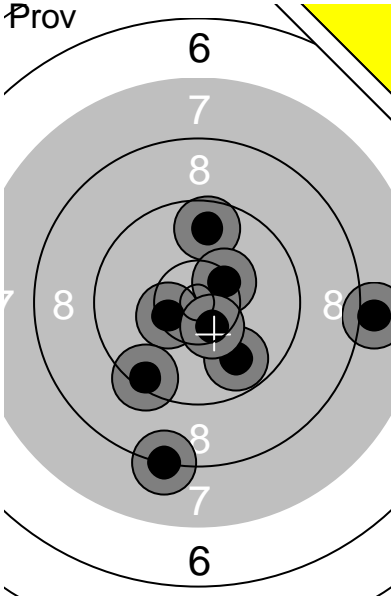
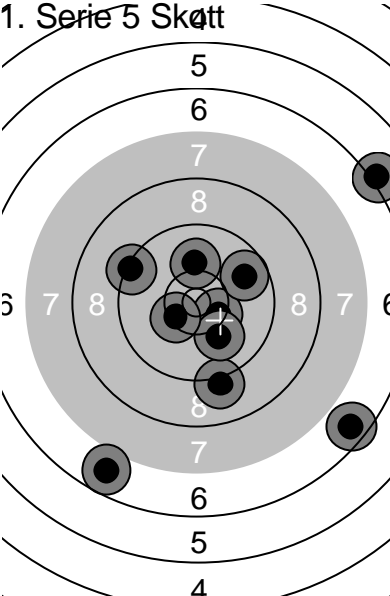
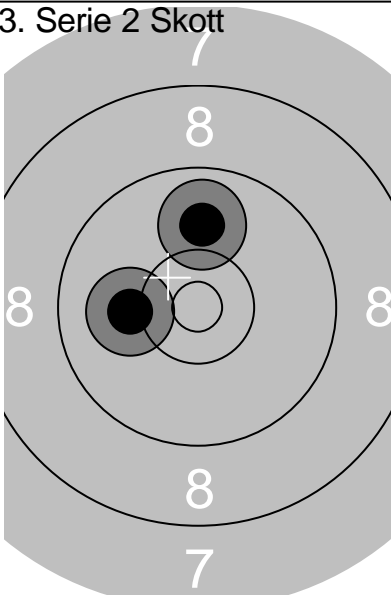
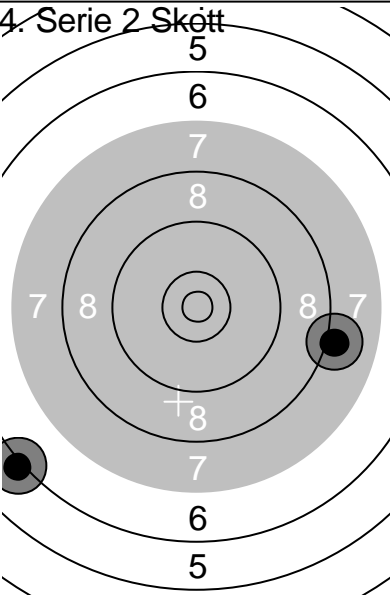
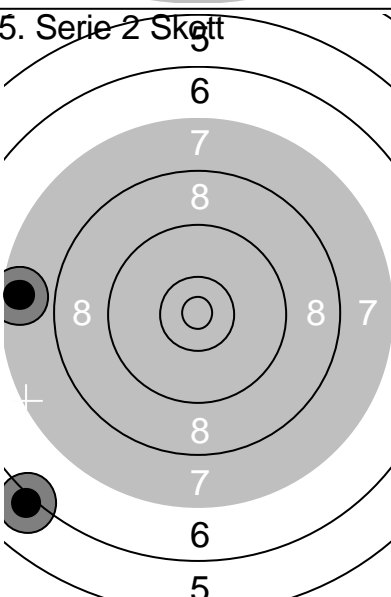
Skjutlag 1	Tavla 25	Brynolf Alexandersson	
S	Umeå Pistolskytteklubb	H 3	
29.02.2020	Final DM	Umeå skytteallians	
Prov		1. Serie 5 Skött 	1: 10.1 ↑ 2: 9.1 ↓ 3: 6.6 ↘ 4: 10.4x ↘ 5: 6.8 ↓ 6: 10.1 ↓ 7: 9.8 ↗ 8: 6.2 ↗ 9: 9.3 ↖ 10: 10.4x ↖ Serie 88.8 Total 88.8
3. Serie 2 Skött		4. Serie 2 Skött 	1: 10.1 ← 2: 9.9 ↑ Serie 20.0 Total 108.8
5. Serie 2 Skött			1: 8.1 → 2: 6.1 ↖ Serie 14.2 Total 123.0
	Serie 76.5 Total 0.0		1: 6.1 ↘ 2: 7.5 ← Serie 13.6 Total 136.6

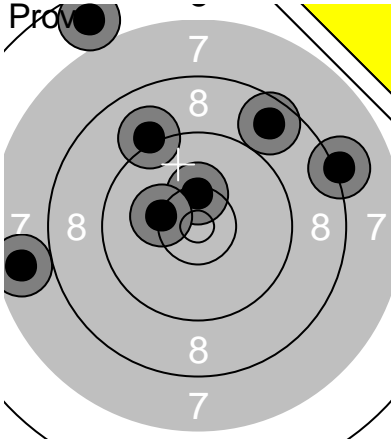
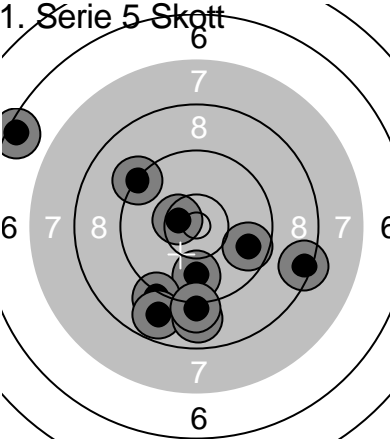
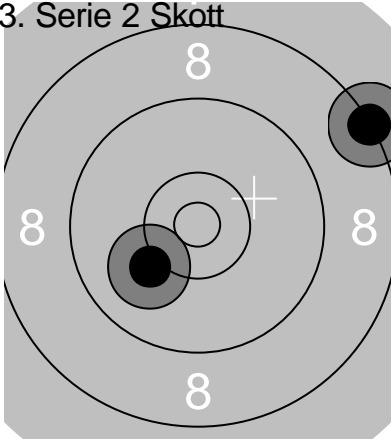
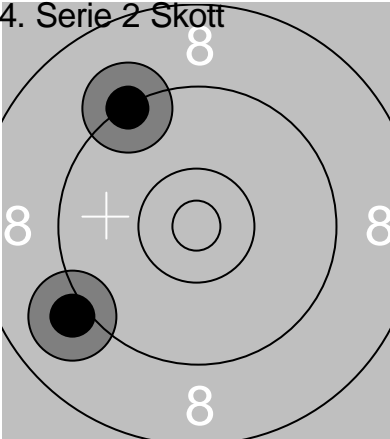
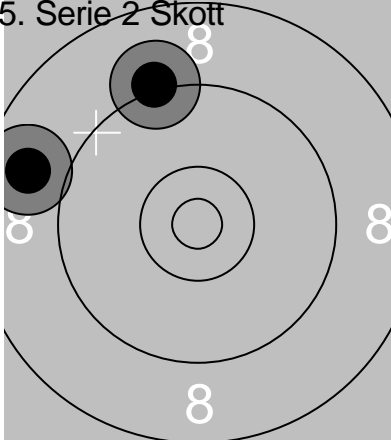
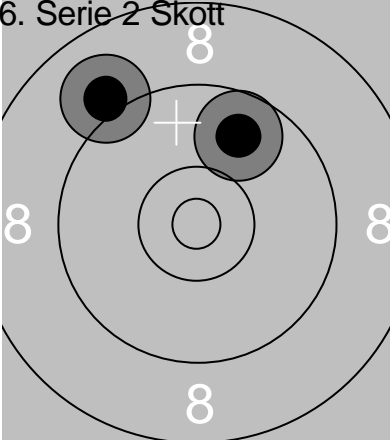
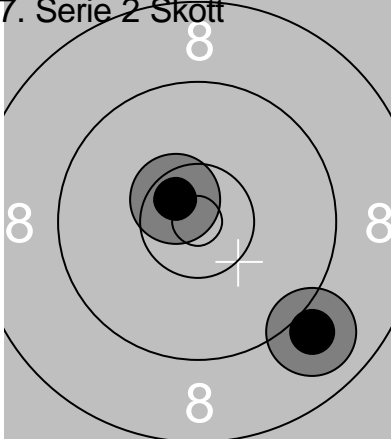
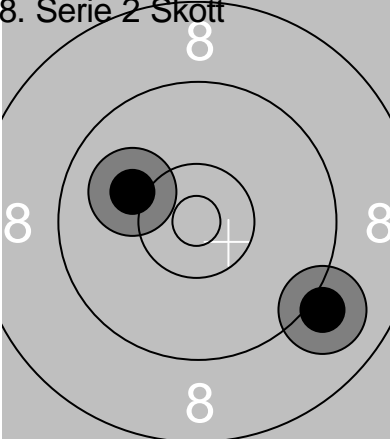
Skjutlag 1	Tavla 26	Patrik Frost																																																																
S		Skellefteå Pistolskytteförening		H 3																																																														
29.02.2020		Final DM		Umeå skytteallians																																																														
	<table border="1"> <tr><td>1:</td><td>10.4x</td><td>↑</td></tr> <tr><td>2:</td><td>6.7</td><td>↗</td></tr> <tr><td>3:</td><td>8.2</td><td>→</td></tr> <tr><td>4:</td><td>10.3</td><td>↖</td></tr> <tr><td>5:</td><td>9.1</td><td>↗</td></tr> <tr><td>6:</td><td>8.7</td><td>↗</td></tr> <tr><td>7:</td><td>7.7</td><td>←</td></tr> <tr><td colspan="2">Serie</td><td>61.1</td></tr> <tr><td colspan="2">Total</td><td>0.0</td></tr> </table>	1:	10.4x	↑	2:	6.7	↗	3:	8.2	→	4:	10.3	↖	5:	9.1	↗	6:	8.7	↗	7:	7.7	←	Serie		61.1	Total		0.0	1. Serie 5 Skott 	<table border="1"> <tr><td>1:</td><td>9.9</td><td>↓</td></tr> <tr><td>2:</td><td>9.3</td><td>↗</td></tr> <tr><td>3:</td><td>9.1</td><td>↘</td></tr> <tr><td>4:</td><td>8.4</td><td>→</td></tr> <tr><td>5:</td><td>8.8</td><td>↘</td></tr> <tr><td>6:</td><td>8.9</td><td>↓</td></tr> <tr><td>7:</td><td>6.4</td><td>↗</td></tr> <tr><td>8:</td><td>9.1</td><td>↓</td></tr> <tr><td>9:</td><td>9.7</td><td>→</td></tr> <tr><td>10:</td><td>10.5x</td><td>↖</td></tr> <tr><td colspan="2">Serie</td><td>90.1</td></tr> <tr><td colspan="2">Total</td><td>90.1</td></tr> </table>	1:	9.9	↓	2:	9.3	↗	3:	9.1	↘	4:	8.4	→	5:	8.8	↘	6:	8.9	↓	7:	6.4	↗	8:	9.1	↓	9:	9.7	→	10:	10.5x	↖	Serie		90.1	Total		90.1
1:	10.4x	↑																																																																
2:	6.7	↗																																																																
3:	8.2	→																																																																
4:	10.3	↖																																																																
5:	9.1	↗																																																																
6:	8.7	↗																																																																
7:	7.7	←																																																																
Serie		61.1																																																																
Total		0.0																																																																
1:	9.9	↓																																																																
2:	9.3	↗																																																																
3:	9.1	↘																																																																
4:	8.4	→																																																																
5:	8.8	↘																																																																
6:	8.9	↓																																																																
7:	6.4	↗																																																																
8:	9.1	↓																																																																
9:	9.7	→																																																																
10:	10.5x	↖																																																																
Serie		90.1																																																																
Total		90.1																																																																
3. Serie 2 Skott 	<table border="1"> <tr><td>1:</td><td>8.3</td><td>↗</td></tr> <tr><td>2:</td><td>10.1</td><td>↘</td></tr> <tr><td colspan="2">Serie</td><td>18.4</td></tr> <tr><td colspan="2">Total</td><td>108.5</td></tr> </table>	1:	8.3	↗	2:	10.1	↘	Serie		18.4	Total		108.5	4. Serie 2 Skott 	<table border="1"> <tr><td>1:</td><td>9.1</td><td>↖</td></tr> <tr><td>2:</td><td>9.3</td><td>↗</td></tr> <tr><td colspan="2">Serie</td><td>18.4</td></tr> <tr><td colspan="2">Total</td><td>126.9</td></tr> </table>	1:	9.1	↖	2:	9.3	↗	Serie		18.4	Total		126.9																																							
1:	8.3	↗																																																																
2:	10.1	↘																																																																
Serie		18.4																																																																
Total		108.5																																																																
1:	9.1	↖																																																																
2:	9.3	↗																																																																
Serie		18.4																																																																
Total		126.9																																																																
5. Serie 2 Skott 	<table border="1"> <tr><td>1:</td><td>8.8</td><td>↖</td></tr> <tr><td>2:</td><td>9.2</td><td>↗</td></tr> <tr><td colspan="2">Serie</td><td>18.0</td></tr> <tr><td colspan="2">Total</td><td>144.9</td></tr> </table>	1:	8.8	↖	2:	9.2	↗	Serie		18.0	Total		144.9	6. Serie 2 Skott 	<table border="1"> <tr><td>1:</td><td>9.8</td><td>↗</td></tr> <tr><td>2:</td><td>9.1</td><td>↗</td></tr> <tr><td colspan="2">Serie</td><td>18.9</td></tr> <tr><td colspan="2">Total</td><td>163.8</td></tr> </table>	1:	9.8	↗	2:	9.1	↗	Serie		18.9	Total		163.8																																							
1:	8.8	↖																																																																
2:	9.2	↗																																																																
Serie		18.0																																																																
Total		144.9																																																																
1:	9.8	↗																																																																
2:	9.1	↗																																																																
Serie		18.9																																																																
Total		163.8																																																																
7. Serie 2 Skott 	<table border="1"> <tr><td>1:</td><td>9.0</td><td>↘</td></tr> <tr><td>2:</td><td>10.6x</td><td>↗</td></tr> <tr><td colspan="2">Serie</td><td>19.6</td></tr> <tr><td colspan="2">Total</td><td>183.4</td></tr> </table>	1:	9.0	↘	2:	10.6x	↗	Serie		19.6	Total		183.4	8. Serie 2 Skott 	<table border="1"> <tr><td>1:</td><td>9.0</td><td>↘</td></tr> <tr><td>2:</td><td>10.1</td><td>↗</td></tr> <tr><td colspan="2">Serie</td><td>19.1</td></tr> <tr><td colspan="2">Total</td><td>202.5</td></tr> </table>	1:	9.0	↘	2:	10.1	↗	Serie		19.1	Total		202.5																																							
1:	9.0	↘																																																																
2:	10.6x	↗																																																																
Serie		19.6																																																																
Total		183.4																																																																
1:	9.0	↘																																																																
2:	10.1	↗																																																																
Serie		19.1																																																																
Total		202.5																																																																

Skjutlag 1	Tavla 27	Peder Johansson																															
S	Nysätra Pistolklubb	H 3																															
29.02.2020	Final DM	Umeå skytteallians																															
Prov		1. Serie 5 Skott																															
<table border="1"> <tr> <td>1: 7.5 ↙</td> <td>6: 10.1 ↗</td> <td rowspan="2">Serie</td> <td rowspan="2">73.4</td> </tr> <tr> <td>2: 9.4 ←</td> <td>7: 9.7 ↗</td> </tr> <tr> <td>3: 9.7 ←</td> <td>8: 8.3 →</td> <td rowspan="2">Total</td> <td rowspan="2">0.0</td> </tr> <tr> <td>4: 8.5 ↙</td> <td></td> </tr> <tr> <td>5: 10.2 ←</td> <td></td> <td></td> <td></td> </tr> </table>	1: 7.5 ↙	6: 10.1 ↗	Serie	73.4	2: 9.4 ←	7: 9.7 ↗	3: 9.7 ←	8: 8.3 →	Total	0.0	4: 8.5 ↙		5: 10.2 ←				<table border="1"> <tr> <td>1: 10.2 ↙</td> <td>6: 9.7 ↑</td> <td rowspan="2">Serie</td> <td rowspan="2">87.8</td> </tr> <tr> <td>2: 8.2 ↖</td> <td>7: 9.1 →</td> </tr> <tr> <td>3: 9.2 ↓</td> <td>8: 7.9 ↙</td> <td rowspan="2">Total</td> <td rowspan="2">87.8</td> </tr> <tr> <td>4: 8.6 ↗</td> <td>9: 10.6x ↗</td> </tr> <tr> <td>5: 6.6 ←</td> <td>10: 7.7 ←</td> <td></td> <td></td> </tr> </table>	1: 10.2 ↙	6: 9.7 ↑	Serie	87.8	2: 8.2 ↖	7: 9.1 →	3: 9.2 ↓	8: 7.9 ↙	Total	87.8	4: 8.6 ↗	9: 10.6x ↗	5: 6.6 ←	10: 7.7 ←		
1: 7.5 ↙	6: 10.1 ↗	Serie			73.4																												
2: 9.4 ←	7: 9.7 ↗																																
3: 9.7 ←	8: 8.3 →	Total	0.0																														
4: 8.5 ↙																																	
5: 10.2 ←																																	
1: 10.2 ↙	6: 9.7 ↑	Serie	87.8																														
2: 8.2 ↖	7: 9.1 →																																
3: 9.2 ↓	8: 7.9 ↙	Total	87.8																														
4: 8.6 ↗	9: 10.6x ↗																																
5: 6.6 ←	10: 7.7 ←																																
3. Serie 2 Skott		4. Serie 2 Skott																															
<table border="1"> <tr> <td>1: 8.0 →</td> <td rowspan="2">Serie</td> <td rowspan="2">17.6</td> </tr> <tr> <td>2: 9.6 ↙</td> </tr> <tr> <td></td> <td rowspan="2">Total</td> <td rowspan="2">105.4</td> </tr> <tr> <td></td> </tr> </table>	1: 8.0 →	Serie	17.6	2: 9.6 ↙		Total	105.4		<table border="1"> <tr> <td>1: 10.0 ↖</td> <td rowspan="2">Serie</td> <td rowspan="2">17.5</td> </tr> <tr> <td>2: 7.5 ↓</td> </tr> <tr> <td></td> <td rowspan="2">Total</td> <td rowspan="2">122.9</td> </tr> <tr> <td></td> </tr> </table>	1: 10.0 ↖	Serie	17.5	2: 7.5 ↓		Total	122.9																	
1: 8.0 →	Serie			17.6																													
2: 9.6 ↙																																	
	Total	105.4																															
1: 10.0 ↖	Serie	17.5																															
2: 7.5 ↓																																	
	Total	122.9																															

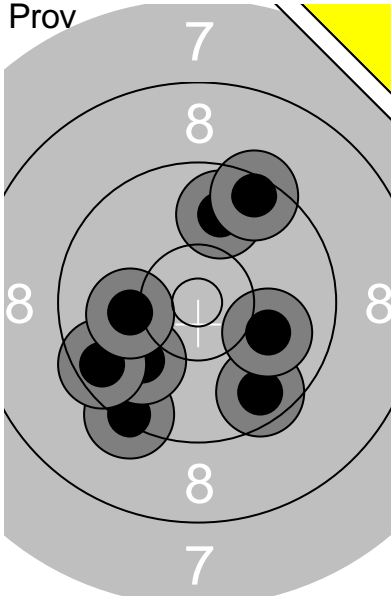
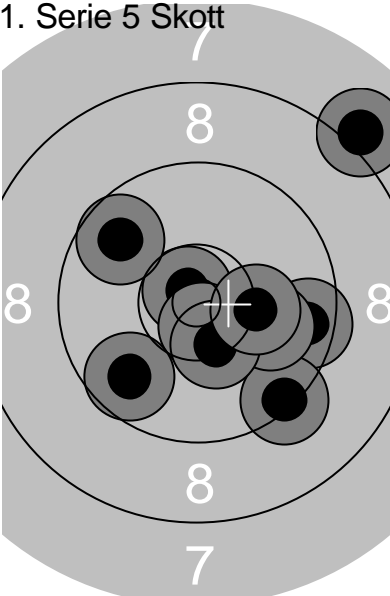
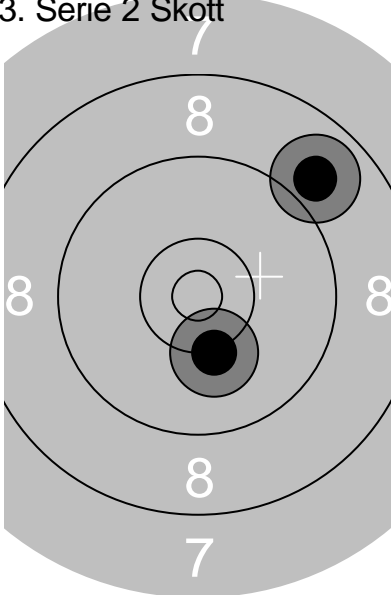
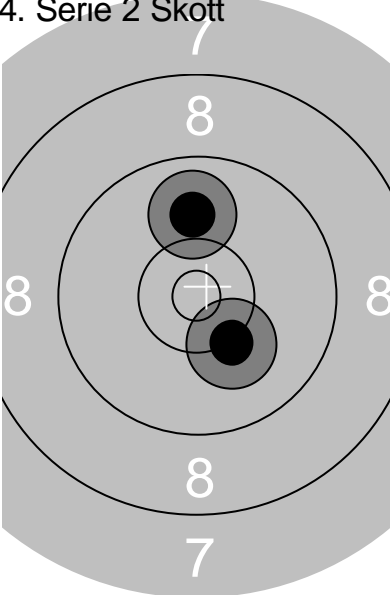
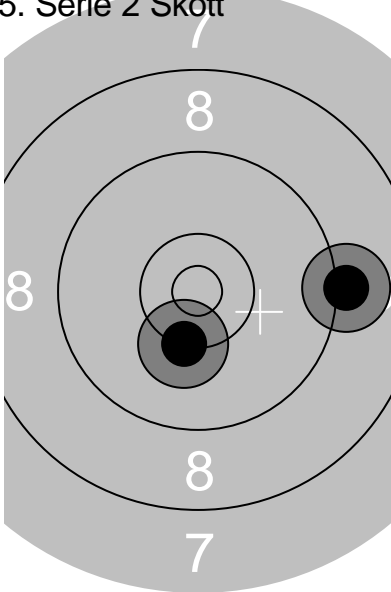
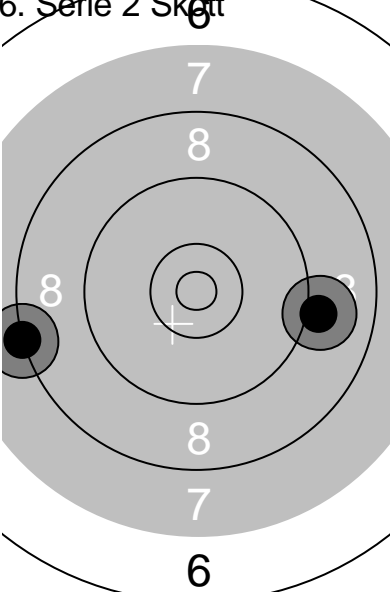
Skjutlag 1	Tavla 29	Åsa Edvinsson			
S	Umeå Pistolskytteklubb		D 3		
29.02.2020	Final DM	Umeå skytteallians			
Prov		1: 9.6 ↘ 2: 9.8 ↑ 3: 9.5 ↗ 4: 9.3 ↙ 5: 10.0 ↙ 6: 9.6 ← 7: 10.1 ← 8: 10.0 →	1. Serie 5 Skott		1: 10.8x ↖ 2: 8.0 ↗ 3: 10.6x ↓ 4: 9.6 → 5: 9.3 ↓ 6: 9.7 ↙ 7: 10.0 → 8: 9.7 ↗ 9: 10.4x ↓ 10: 10.2 →
	Serie 77.9		Serie 98.3		
	Total 0.0		Total 98.3		
3. Serie 2 Skott		1: 8.9 ↗ 2: 10.2 ↓	4. Serie 2 Skott		1: 10.2 ↓ 2: 9.9 ↑
	Serie 19.1		Serie 20.1		
	Total 117.4		Total 137.5		
5. Serie 2 Skott		1: 9.1 → 2: 10.3 ↓	6. Serie 2 Skott		1: 9.1 → 2: 8.2 ←
	Serie 19.4		Serie 17.3		
	Total 156.9		Total 174.2		

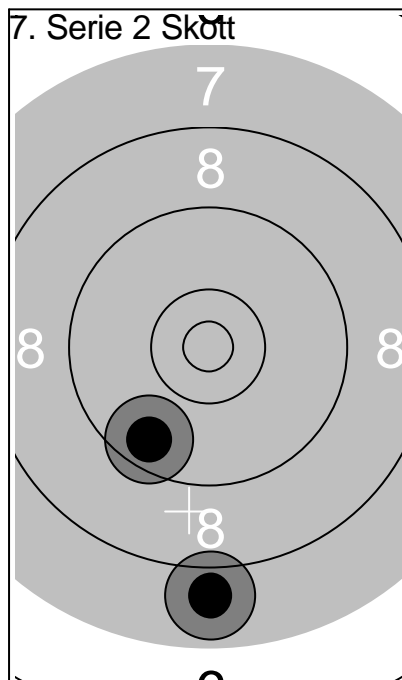

1:	7.9	↓
2:	9.6	↙
Serie		17.5
Total		191.7

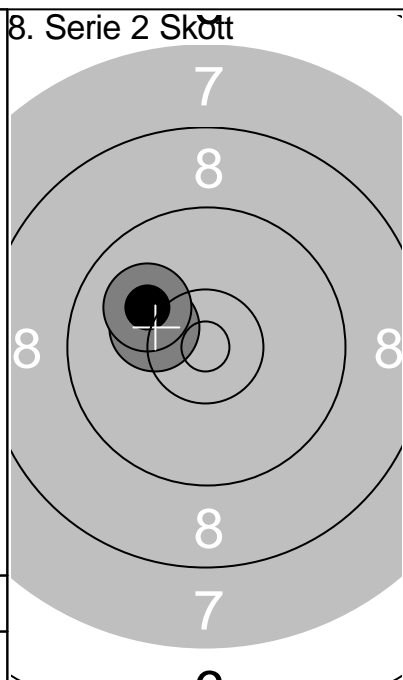

1:	10.3	←
2:	10.1	↙
Serie		20.4
Total		212.1

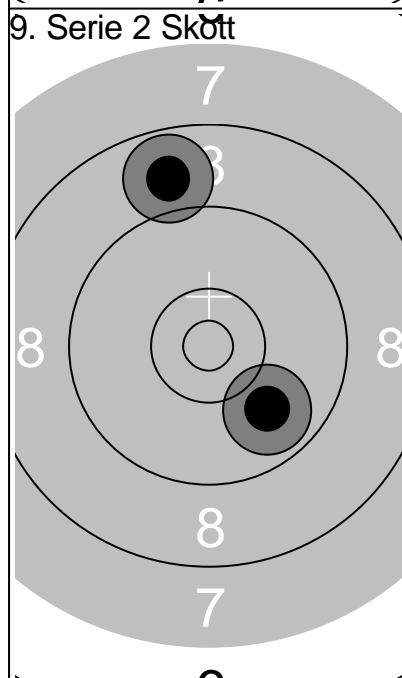

1:	9.9	↘
2:	8.8	↑
Serie		18.7
Total		230.8

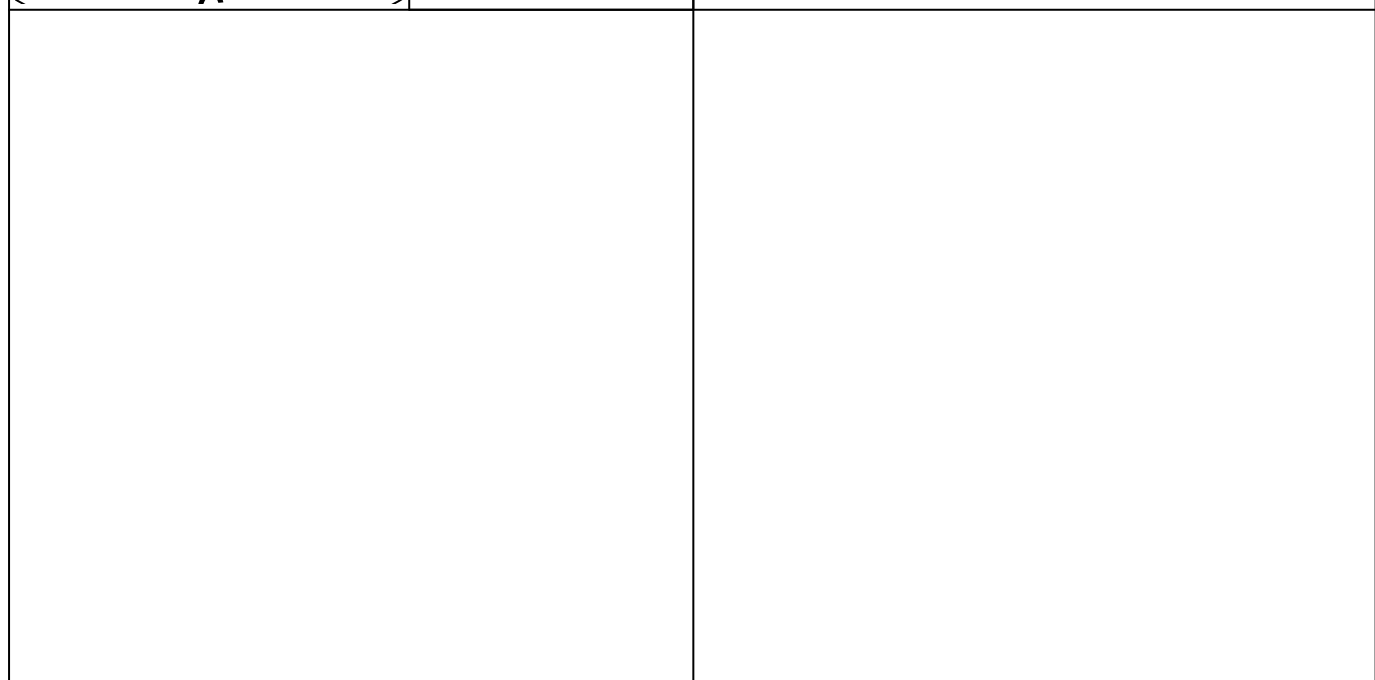

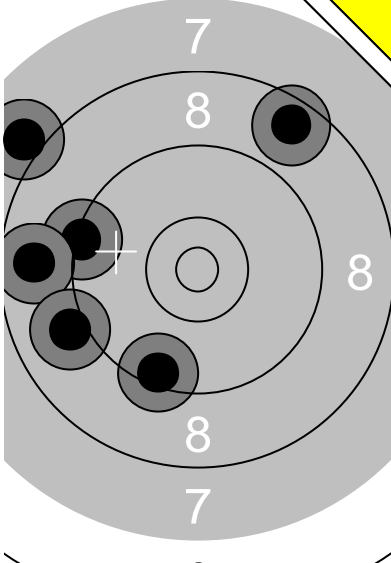
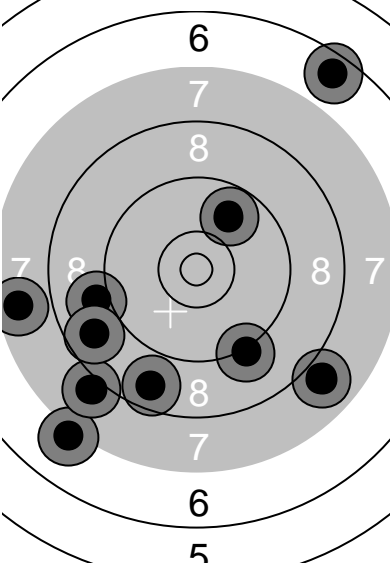
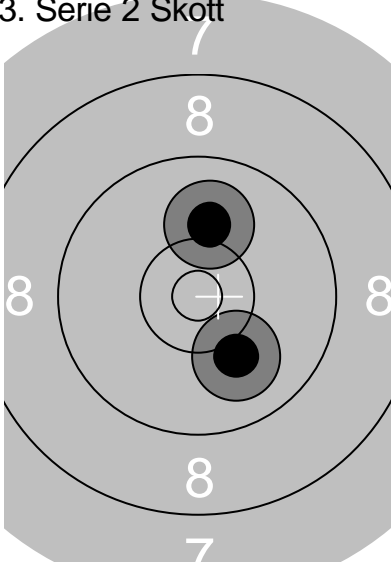
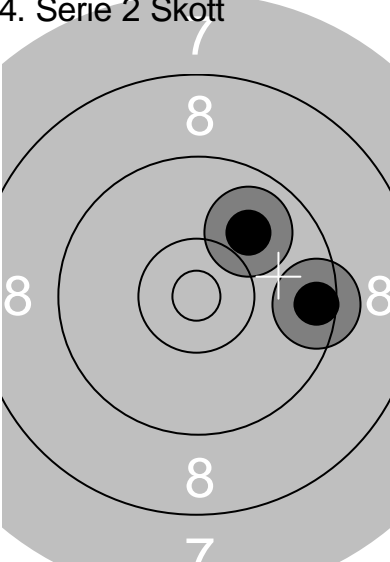
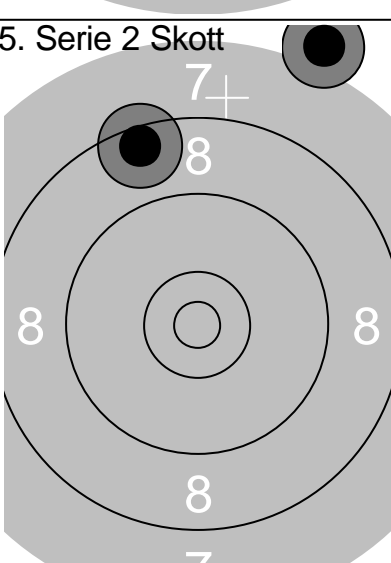
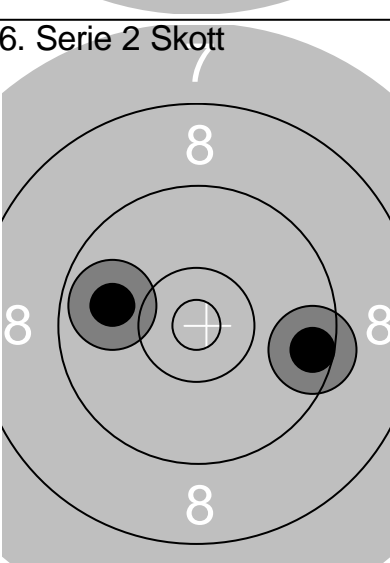
Skjutlag 1	Tavla 30	Ida Backlund		
S	Umeå Pistolskytteklubb	D 3		
29.02.2020	Final DM	Umeå skytteallians		
Prov		1: 9.3 ← 2: 8.7 ← 3: 9.4 ↓ 4: 8.6 ↗ 5: 8.0 ↖ 6: 9.0 ←	1. Serie 5 Skott 	1: 7.6 ← 2: 6.6 ↗ 3: 9.2 ↓ 4: 9.0 ← 5: 7.1 ↓ 6: 8.7 ↓ 7: 8.0 ← 8: 7.9 ↘ 9: 9.8 ↗ 10: 8.7 ←
	Serie 53.0		Serie 82.6	
	Total 0.0		Total 82.6	
3. Serie 2 Skott		1: 10.1 ↘ 2: 10.1 ↗	4. Serie 2 Skott 	1: 9.9 ↗ 2: 9.5 →
	Serie 20.2		Serie 19.4	
	Total 102.8		Total 122.2	
5. Serie 2 Skott		1: 6.9 ↗ 2: 8.5 ↗	6. Serie 2 Skott 	1: 9.9 ← 2: 9.5 →
	Serie 15.4		Serie 19.4	
	Total 137.6		Total 157.0	

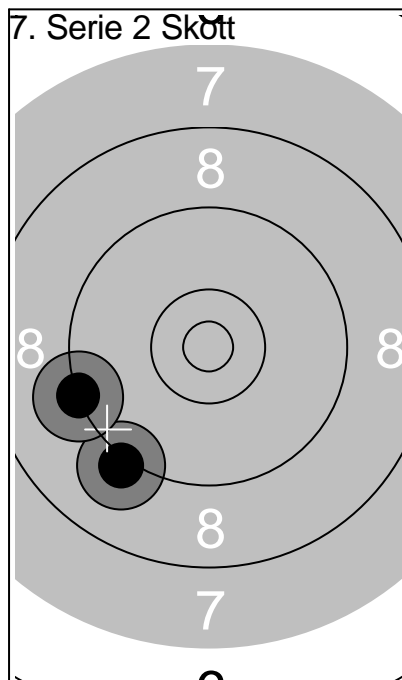

1: 9.1 ↙
2: 9.2 ←

Serie	18.3
Total	175.3

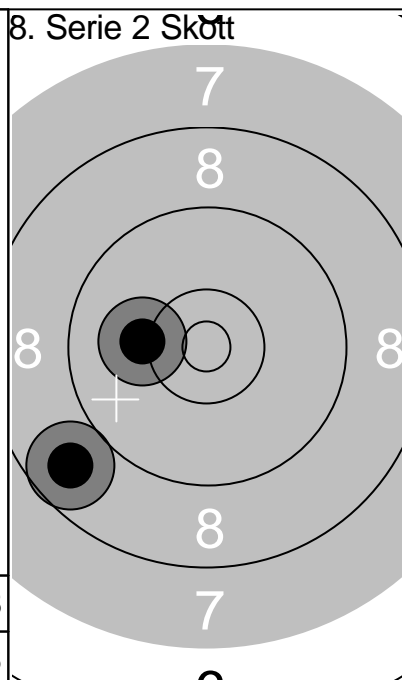

1: 8.7 ↙
2: 10.2 ←

Serie	18.9
Total	194.2

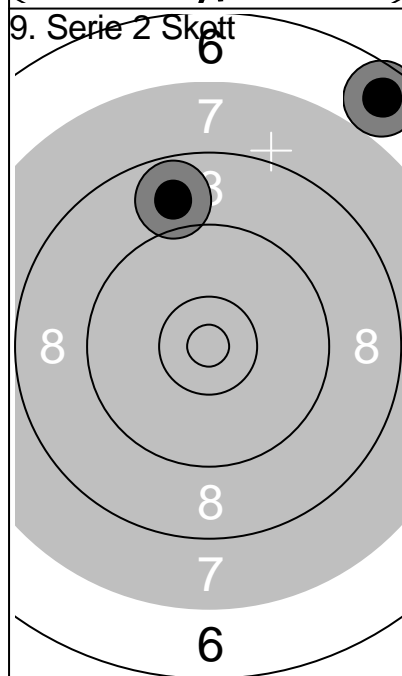

1: 6.7 ↗
2: 8.8 ↑

Serie	15.5
Total	209.7

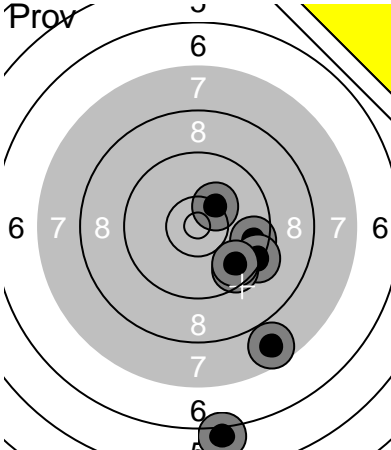
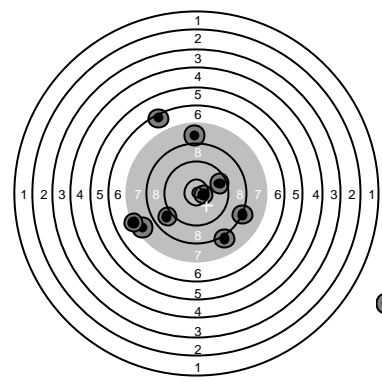
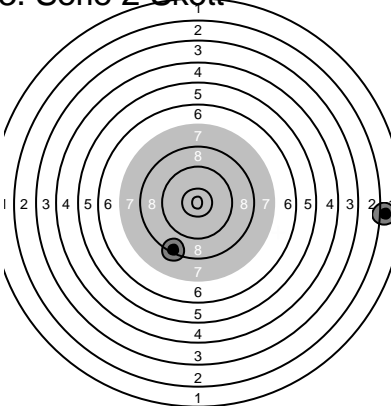
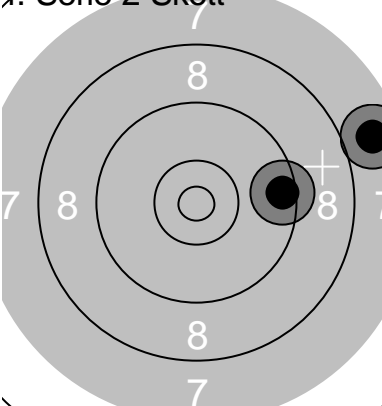
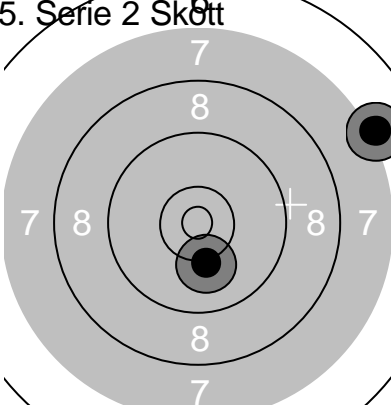
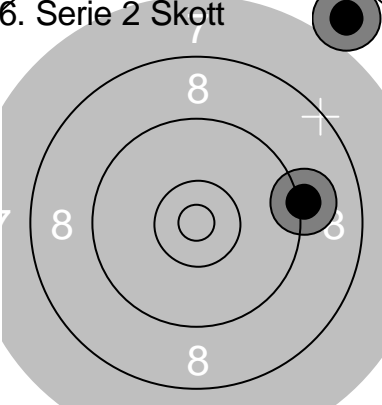
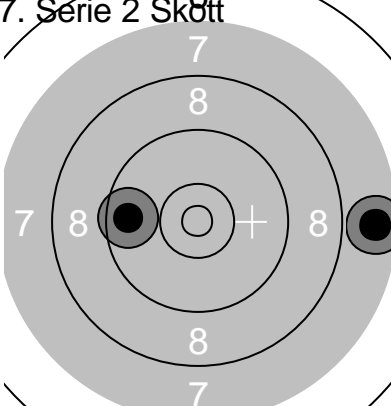
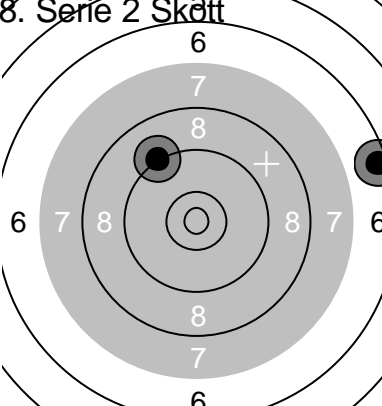
Skjutlag 1	Tavla 31	Charlotte Ågren	
S	Vännäs Pistolskytteklubb	D 3	
29.02.2020	Final DM	Umeå skytteallians	
Prov		1: 9.6 → 2: 6.1 ↓ 3: 9.4 ↓ 4: 7.7 ↓ 5: 9.6 ↓ 6: 9.7 ↓ 7: 10.3 ↗	1. Serie 5 Skott 
	Serie 62.4 Total 0.0	1: 7.6 ↙ 2: 8.1 ↘ 3: 9.0 ↙ 4: 0.0 ↘ 5: 7.9 ↑ 6: 7.3 ↙ 7: 6.5 ↗ 8: 9.6 → 9: 10.6x → 10: 8.3 ↘	Serie 74.9 Total 74.9
3. Serie 2 Skott		1: 2.1 → 2: 8.4 ↓	4. Serie 2 Skott 
	Serie 10.5 Total 85.4	1: 9.5 → 2: 7.7 →	Serie 17.2 Total 102.6
5. Serie 2 Skott		1: 7.1 → 2: 10.2 ↓	6. Serie 2 Skott 
	Serie 17.3 Total 119.9	1: 9.2 → 2: 6.8 ↗	Serie 16.0 Total 135.9
7. Serie 2 Skott		1: 7.7 → 2: 9.7 ←	8. Serie 2 Skott 
	Serie 17.4 Total 153.3	1: 9.2 ↗ 2: 6.5 →	Serie 15.7 Total 169.0